



2025





*Kaliteyi deneyimleyin*

*Experience the quality*

# KAPP ÜRETİM TESİSLERİ MANUFACTURING FACILITIES





# İçindekiler

## Piştirme



10	Düdüklü Tencere	26/27	Tavalar Döküm Döküm
15/16	Silindirik Tencereler	28	Kızartma Örtüsü Çelik
17	Kapaklar	29	Fırın Tepsileri
18	Helvane Tencereler		
19	Makarna Piştirme Süzgeç		
19	Kuskus Süzgeci		
21	Tavalar		
23	Kaçarola		
24	Tavalar (Alüminyum Teflon)		
25	Tencereler Döküm		

## Hazırlık



34/41	GN Küvetler	56	Domates	63	Sipariş Tutucu	70	Tel Süzgeç
42	Küvetler (Bain Marie)	57	Dilimleyici	63	Şef Cimbızı	70	Kevgir
43	Hamur Teknesi PP	58	Sebze/Meyve	63	Şaşula	70	Tencere Teli
44	GN Küvetler Porselen	59	Doğrayıcı	64	Teraziler	71	Tava Teli
45	GN Ekipmanları	59	Püre Makinesi	64	Rendeler	71	Fırça
48/49	PC Küvetler	59	Konserve Açacağı	65	Öçülü Kaplar	73	Pizza Rulleti
72/73	Çırpıcı	59	EkmeK Kesim	65	Öçek Seti	73	Hamur Kazıyıcısı
76/82	Bıçaklar	60	Hamburger	66/67	Termometreler	74	Kesim Levhaları
85/86	Tütsüleyiciler	60/61	Şekillendirici	68	Kalbur	74	Kesim Levhası İstif Teli
51	PC Saklama Kapları	62	Gıda Püskürtme	68	Elek	83	Et Çengeli
52	PP Saklama Kapları	62	Makinesi	68	Süzgeç	83	Çelik Eldivenler/Önlük
53	Sebze Kurutucu	63	Parizyen Kaşıkıar	69	Çin Külahlı	83	Bıçaklık Miknatıslı
54	Japon Tornası	63	El Aletleri	69	Konik Süzgeç	83	Bıçak Sterilizatörü
54	Mandolin Kesme	63	Makaslar	69	Makarna Süzgeç	87	Dehidratörler
55	Ananas Soyma	63	Sarmısak Ezici	70	Hunı (Süzgeçli)		
55	Patates Dilimleme	64	Sos Hunisi	70	Derin KePçe		

## Pastacılık



90/92	Yapışmaz Kalıplar	109	Volovan	113	Krema Torbası
93/99	Silikon Kalıplar	109	Pandispanya Testeresi	113	Duy Set
100	Fiber Örtüler	110	Kruvasan Merdane	114	Yanmaz Eldiven
101/103	Çikolata Kalıpları	110	Poli Merdane	114	Pürmüz
104/105	Çikolata Ekipmanları	110	Hamur Kazıyıcısı	116	Pasta Standı
104	Çikolata Eritme Makinası	110	Rulet	116	Elektrikli Stand
104	Gıda Püskürtme Makinası	111	EkmeK Jileti	117/119	Spatulalar
105	Püskürtme Kompresörü	111	Erişte Makinası		
105	Gitar Set	111	EkmeK Mayalama Sepetleri		
106/109	Paslanmaz Çelik Kalıplar	112	Kabartma Kabı		

## Servis



122	Kaydırmaz Tepsiler	129	PC Kaşık Servis
123	Self Servis Tepsi	129	PC KePçe/Maşa
123/124	Servis Tepsi	131	Şef Cimbızı
125	KePçeler	132	Kaşık Standı
125	Kevgirler	132	Dondurma Kaşığı
127	Servis Pilav	132	Pilav Öçeği
127	Kaşıklar	132	Patates Küreği
127	Servis Çatalı	133	Sos Dispenserleri
128	Servis Spatula	133	Sos Şişeleri
129/131	Maşalar	133	Sos/Şurup Dökücü
129	Silikon Maşalar		

## Açık Büfe



136/149	Titan Chafing Dish	174	İsimlik
152/155	Vega Chafing Dish	174	Kaşık Standı
158/163	Carina Chafing Dish	178/179	Sıcak Tutucu Lambalar
165/166	Premium Chafing Dish	180/181	Açık Büfe Standları
189	Kayrak Sunumluklar	182	Açık Büfe Yükselticiler
167	İndüksiyon Ocak Gömme	183	Açık Büfe Sunumluklar
169/170	Delux Chafing Dish	184/188	Açık Büfe Melamin Sunumluklar
170/172	Dispenserler	189	Sunum Tepsileri
171	Klasik Chafig Dish	189	EkmeK Sepetleri
172	Ekonomik Chafing Dish		
173	Chafing Dish Küvetler		

## Restaurant



194	Ahşap Sunumluklar	201	Masa Lambası
195	Tabaklar PC	202	Ekmek Sepetleri
196/197	Tuz & Karabiber Değirmeni	203	Küllükler
196/197	Tuzluk & Karabiberlik		
198/200	Peçetelikler		
200	Kırıntı Küreği		
201	Sunum Kapakları		
201	Sos Teknesi		
201	Dondurmalık		

## İçecek



206/208	Kahve Makinaları	218	Dondurma Makinesi
209	Kahve Öğütücüsü	218	Buzlu İçecek Makinesi
219	Blenderlar	220	Narenciye Sıkacağı
210	Süt Potları	220	Buz Kırıcı
210	Kahve Termometresi	221	Buz Makineleri
211/217	Şerbetlik	222	Dispenserler
211/218	İçecek Makineleri	223	Termos
217	Sıcak Çikolata	224/225	PC Bardaklar

## Bar



228	Buz Kovaları
228	Şampanya & Şarap Kovaları
230	Shaker
230	Punch Kasesi
231/232	Bar Ekipmanları
232	Soda Sifonu
233	Çerezlikler
234	Tepsiler Kaydırmaz
235	Küllükler

## Ekipmanlar



238	Rowzer	270/271	Vakumlu Paket Makinesi
239/240	Mycook	272/275	Soft Cooker
241/245	El Blenderlar	276/277	Kombi Fırın
246	Dilimleyici Bıçaklar	278	Şok Soğutucu
246/252	Sebzeye Doğrayıcı	279	Hızlı Pişirme Fırını
253	Peynir Rendeleyici	280	Mikrodalga Fırın
254	Hamur Açma Makinesi	281	İndüksiyon Ocaklar
255	Makarna Erişte Makinesi	282/286	Blenderlar
256/264	Gıda Dilimleyici	287	Narenciye Sıkacağı
265	Çift Kollu Mikser	288	Buz Kırıcı
266/267	Planet Mikser	289	Yağ Filtreleme Makinesi
268/269	Et-Kemik Testeresi		

## Taşıma / Depolama



292/295	Thermobox PC
296	Taşıma Kovaları
297	Sefer Tasları
297	Thermobox Arabası
297	Taşıma Tepsisi
299/300	Servis Arabaları
302/303	Taşıma Arabaları
303/305	Raflar

## Bulaşık

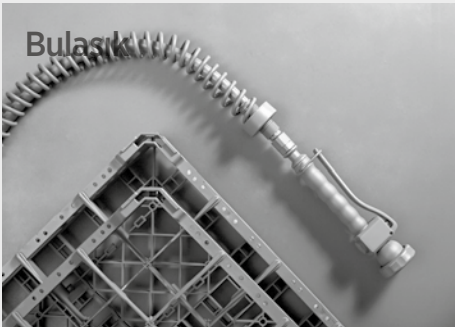

308/310	Basketler
313/314	Yükselticiler
315	Bulaşık Yıkama
315	Eyeye
315	Çöp Kovası
316	Sinek Öldürücüler
317	Basket Arabası

# Index

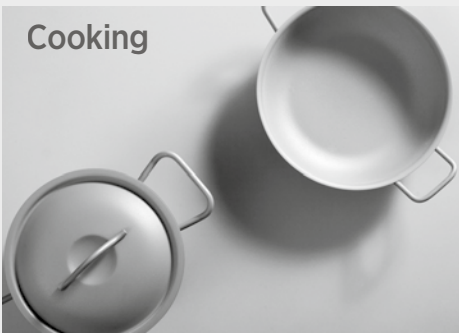

10	Pressure Cooker	26/27	Pots Cast Iron
15/16	Stock Pots	28	Roasteasy
17	Lids	29	Roasting Pans
18	Wide Shallow Pots		
19	Colander Pasta		
19	Colander Couscous		
21	Pans		
23	Sauce Pan		
24	Pans (Aluminum Non-Stick)		
25	Pots Cast Iron		



34/41	GN Food Pans	55	French Fry Cutter	63	Chef's Tong	70	Skimmer
42	Containers (Bain Marie)	56	Tomato Slicer	63	Scoop	70	Strainer For Pot
43	Dough Tray PP	57	Vegetable/Fruit Cutter	64	Scales	70	Strainer For Pan
44	Food Pans Porcelain	58	Food Mill	64	Graters	71	Whisk
45	GN Equipments	59	Can Opener	65	Calibrated Cups	71	Brush
48/49	PC GN Pans	59	Bread Cutting Board	65	Measuring Cup Set	73	Pizza Roulette
72/73	Spatulas	59	Hamburger Press	66/67	Thermometers	73	Dough Scraper
76/82	Knives	59	Food Spray Gun	68	Grate	74	Cutting Boards
85/86	Smokers	60	Melon Ballers	68	Sieve	74	Cutting Board Rack
51	PC Storage Containers	60/61	Kitchen Utensils	68	Colander	83	Meat Hook
52	PP Storage Containers	62	Scissors	69	Chinese Colaner	83	Chain Gloves/Apron
53	Salad Spinner	62	Garlic Press (S/S)	69	Conical Strainer	83	Magnetic Board
54	Turning Slicer	63	Sauce Gun	69	Colander Pasta	83	Knife Sterilizer
54	Mandoline	63	Tickets-Holder	70	Funnel w/Strainer	87	Dehydrators
55	Pineapple Peeler			70	Round Strainer		



90/92	Moulds Nonstick	109	Cutter	113	Pastry Bags
93/99	Silicone Moulds	109	Ganoese Saw	113	Icing Tip Big Set
100	Baking Sheets Silicone	110	Croissant Roller Cutter	114	Oven Mitt
101/103	Chocolate Moulds	110	Poli Roller	114	Torch
104/105	Chocolate Equipments	110	Dough Scraper	116	Electrical Stand
104	Chocolate Melting Machine	110	Pastry Rollers	116	Cake Stand
104	Food Spray Gun	111	Baker's Blade Disposable	117/119	Spatulas
105	Pastry Compressor	111	Pasta Maker Manual		
105	Guitar Set	111	Bannetons		
106/109	Stainless Steel Moulds	112	Cream Whipper		



122	Non-slip Trays	129	PC Spoon Serving
123	Self Service Trays	129	PC Ladle/Tong
123/124	Serving Tray	131	Chef's Tong
125	Ladles	132	Spoon Rest
125	Skimmers	132	Ice Cream Spoon
127	Service Spoons	132	Rice Scoop
127	Serving Forks	132	French Fries Shovel
127	Turner Perforated	133	Sauce Dispensers
128	Serving Utensils	133	Sauce Bottle
129/131	Tongs	133	Pouring Container
129	Silicone Tongs		



136/149	Chafing Dish Titan	174	Name Tag
152/155	Chafing Dish Vega	174	Spoon Rest
158/163	Chafing Dish Carina	178/179	Heat Retaining Lamps
165/166	Chafing Dish Premium	180/181	Buffet Service Stands
189	Slate Display Plates	182	Buffet Service Elevators
167	Induction Cooker Built-In	183	Buffet Displays
169/170	Chafing Dish Deluxe	184/188	Buffet Displayers Melamine
170/172	Dispensers	189	Display Trays
171	Chafing Dish Classic	189	Bread Baskets
172	Chafing Dish Economic		
173	Chafing Dish Food Pans		

## Table-top



194	Wooden Displays	201	Table Lamp
195	Plates PC	202	Bread Baskets
196/197	Salt & Pepper Mill	203	Ashtrays
196/197	Salt & Pepper		
198/200	Napkin Holders		
200	Table Crumbler		
201	Display Covers		
201	Gravy Boat		
201	Ice Cream Cup		

## Beverage



206/208	Coffee Machines	218	Granita & Ice Slush Dispenser
209	Grinders	218	Ice Slush Dispenser
219	Blenders	220	Citrus Juicer
210	Milk Pots	220	Ice Crusher
210	Coffee Thermometer	221	Ice Makers
211/217	Juice Cooler	222	Dispensers
211/218	Beverage Machines	223	Insulated Beverage Server
217	Hot Chocolate Dispenser	224/225	Glasses PC

## Bar



228	Ice Buckets
228	Champagne & Wine Buckets
230	Shaker
230	Punch Bowl
231/232	Bar Equipments
232	Soda Siphon
233	Appetizer Displays
234	Trays Non-slip
235	Ashtrays

## Kitchen Appliances



238	Rowzer	270/271	Vacuum Packaging Machine
239/240	Mycook	272/275	Soft Cooker
241/245	Stick Blenders	276/277	Combination Oven
246	Discs	278	Blast Chiller
246/252	Vegetable Cutter	279	Speed Oven
253	Cheese Grater	280	Microwave Oven
254	Pasta Roller	281	Induction Cookers
255	Pasta Machine	282/286	Blenders
256/264	Slicer	287	Citrus Juicer
265	Double Arm Mixer	288	Ice Crusher
266/267	Planet Mixer	289	Oil Filter Machine
268/269	Bone Saw		

## Carrying / Storage



292/295	Thermobox PC
296	Carrying Containers
297	Portable Food Containers
297	Thermobox Trolley
297	Carrying Tray
299/300	Service Trolleys
302/303	Carrying Trolleys
303/305	Shelves

## Dish Washing



308/310	Racks
313/314	Extenders
315	Dish Washing
315	Sink
315	Rubbish Bin
316	Insect Killers
317	Rack Trolley





**Piřirme**/Cooking



10

» Düdüklü Tencere / Pressure Cooker

Kod Code	Øxh (cm) Øxh (cm)	Lt Lt	Koli/Adet Pcs/Ctn
32383219	32x19	15	1
32383223	32x23	18	1
32383230	32x30	23	1

Kod Code	Øxh (cm) Øxh (cm)	Ø (cm) Ø (cm)	Koli/Adet Pcs/Ctn
35700032	Düdüklü Tencere Kapak / Pressure Cooker Lid	32	1
30210132	Konveks Kapak / Convex Lid	32	1
35700154	Silikon Kapak Contası / Silicone Seal	32	2



- 1,20 mm kalınlığında 304 kalite paslanmaz elik
- Gvenlik iin 2 adet emniyet valfi mevcuttur;  
1. valf aılmadıđı takdirde, 2. valf devreye girer
- Buhar bořaltma valfi 3 konumdan oluřur: 1. ve 2. konum piřirmede, 3. konum buhar bořaltmada kullanılır
- İnovatif kapak tasarımı, kolay kullanılabilen kilit sistemi
- Kapak paraları sklp takılabilir ve yıkanabilir
- İndüksiyon ocaklara uygundur

- 18/10 Stainless Steel, 1,20 mm thickness
- 2 Independent Safety Valves for Security;  
If valve 1 is not opened, valve 2 is activated
- Blowoff valve consists of 3 positions: 1. and 2. position is for cooking, 3. position is for blowoff
- Innovative Lid with Easy to Use Locking System
- Easy cleaning with removable lid attachments
- Suitable for induction cookers





- KAPP stands out with “IMPACT BONDED” three layered sandwich bottom in all lines and sizes.
- KAPP is the only brand which offers “induction ready” cookware in ALL sizes.



## QUALITY

KAPP products are extremely robust. Tried and tested up to the highest standards. By leveraging our strengths in product design, packaging and distribution; we provide unique, innovative solutions for Professional Kitchens.

KAPP products are manufactured by means of attentive production processes and only delivered after strict quality controls.

All the procedures are monitored by our Quality Management System which is certified by TUV, GOST, HACCP and CE internationally.

“The Great Lake Culinary Institute Laboratories” in USA, tested and approved our quality and classified KAPP products within the best quality product ranges in the world.

## TEKNOLOJİ VE KALİTE GELENEĞİ

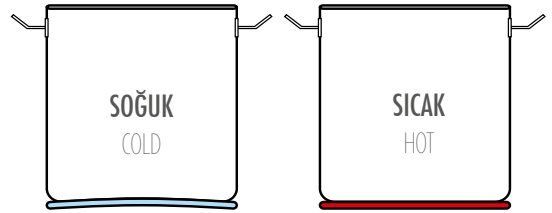

### ÇAKMA TABAN /IMPACT BOUNDING

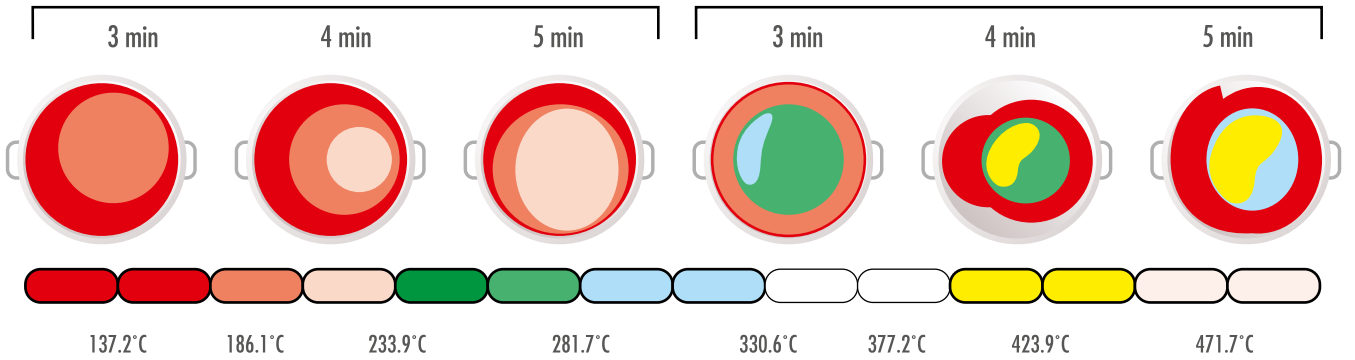

\* Tencere tabanı 2500 ton üzerinde kuvvetle çakılmaktadır.

/ Bases are forged bound by over 2500 tons pressure

\* %95 oranında saf alüminyum

/ %95 pure aluminum

\* Taban saclarında %99 üzerinde birleşme

/ Bottom plates combine chemically over %99



Mükemmel eşit pişirme  
Perfect even cooking

### YAPIŞTIRMA TABAN / BRAZED BOTTOM

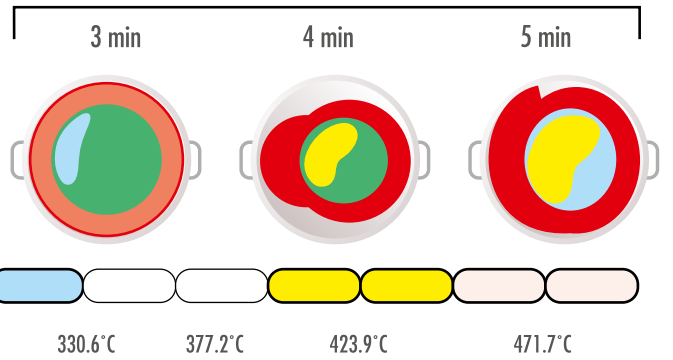

\* Yapışma makinesiyle birleştirme

/ Combined with brazing machine

\*Normal, saf olmayan alüminyum

/ Standart aluminum, not pure

\*3. Katın %55 oranında birleşmesi

/ %55 combining of the 3. Layer



Yapışma, yanma ihtimali - Değişken ısı  
Sticking, burning possibility Variable heat



Yapışma, yanma - Yüksek ısı  
Sticking, burning High heat

- Ekstra puntalarla güçlendirilmiş saplar dayanıklılığı artırır, en büyük boy tencereler de dahil ağırlıktan kaynaklı bükülme yaşanmaz.

*Handles are reinforced with extra durability, there is no weight-induced bending, even in the largest pots.*

- Her tencerenin sapında üretildiği tarih yazılıdır. Ürünlerin kalite kontrolü ve takibi mutfaklara girdikten sonra da devam eder. Her tencere 5 yıl garantiye sahiptir.

*Each pot has its production date on its handles. Quality control and follow-up of the products continue after entering the kitchens. Each pot has a 5 year warranty.*



- "Impact" taban teknolojisiyle her ürünün tabanı 5 yıl süreyle Kapp garantisi altındadır.

*Every product with "Impact" base technology is under Kapp's guarantee for 5 years.*



» Derin (Kapaklı) / Jumbo Stockpot (w/lid)

Kod Code	Øxh (cm) Øxh (cm)	Lt Lt	Koli/Adet Pcs/Ctn
30141616	16x16	3,0	4
30142020	20x20	6,3	4
30142424	24x24	10,5	2
30142828	28x28	17,2	2
30143030	30x30	21,2	1
30143231	32x32	26,0	1
30143635	36x36	36,6	1
30144040	40x40	50,0	1
30144544	45x45	70,0	1
30145050	50x50	100,0	1
30146055	60x55	155,0	1

» Orta Derin (Kapaklı) / Stockpot (w/Lid)

Kod Code	Øxh (cm) Øxh (cm)	Lt Lt	Koli/Adet Pcs/Ctn
30142017	20x17	5,3	4
30142419	24x19,5	8,8	4
30142823	28x23	14,2	2
30143024	30x24	17,0	2
30143227	32x27,5	22,1	2
30143629	36x29	29,5	1
30144032	40x32	40,2	1
30144528	45x28	44,0	1
30145030	50x30	58,0	1
30146035	60x35	99,0	1

» Orta (Kapaklı) / Deep Casseroles (w/Lid)

Kod Code	Øxh (cm) Øxh (cm)	Lt Lt	Koli/Adet Pcs/Ctn
30141611	16x11	2,0	4
30141812	18x12	3,0	4
30142013	20x13	4,1	4
30142214	22x14	5,3	4
30142415	24x15	6,8	4
30142817	28x17	10,5	2
30143020	30x20	14,1	2
30143219	32x19	15,3	2
30143622	36x22	22,4	2
30144025	40x25	32,0	1
30144522	45x22	35,0	1
30146025	60x25	70,0	1



» Orta Siğ (Kapaklı) / Shallow Casseroles (w/Lid)

Kod Code	Øxh (cm) Øxh (cm)	Lt Lt	Koli/Adet Pcs/Ctn
30141608	16x7	1,4	4
30141809	18x8	2,0	4
30142010	20x9	3,0	4
30142210	22x9,5	3,6	4
30142411	24x10,5	5,0	4
30142812	28x12	7,4	4
30143012	30x12	8,4	2
30143215	32x15	12,1	2
30143617	36x17	17,3	2
30144019	40x19	25,0	1
30145020	50x20	39,0	1

» Siğ Tencere (Kapaklı)

Shallow Casseroles (w/lid)

Kod Code	Øxh (cm) Øxh (cm)	Lt Lt	Koli/Adet Pcs/Ctn
30142475	24x7,5	3,5	4
30142807	28x7	4,3	4
30143275	32x7,5	6,0	2
30143608	36x8	8,1	2
30144008	40x8	10,0	2
30144510	45x10	15,9	1
30145010	50x10	20,0	1
30146010	60x10	28,3	1

## Silindirik Tencereler / Stock Pots - Casseroles



### » Derin Tencere

Jumbo Stock Pot

Kod Code	Øxh (cm) Øxh (cm)	Lt Lt	Koli/Adet Pcs/Ctn
30311616	16x16	3,0	4
30312020	20x20	6,3	4
30312424	24x24	10,5	2
30312828	28x28	17,2	2
30313030	30x30	21,2	1
30313231	32x32	26,0	1
30313635	36x36	36,6	1
30314038	40x40	50,0	1
30314544	45x45	70,0	1
30315050	50x50	100,0	1
30316055	60x55	155,0	1

### » Orta Derin Tencere

Stock Pot

Kod Code	Øxh (cm) Øxh (cm)	Lt Lt	Koli/Adet Pcs/Ctn
30312017	20x17	5,3	4
30312419	24x19,5	8,8	4
30312823	28x23	14,2	2
30313024	30x24	17,0	2
30313228	32x27,5	22,1	2
30313629	36x29	29,5	1
30314032	40x32	40,0	1
30314528	45x28	44,0	1
30315030	50x30	58,0	1
30316035	60x35	99,0	1

### » Orta Boy Tencere

Deep Casseroles

Kod Code	Øxh (cm) Øxh (cm)	Lt Lt	Koli/Adet Pcs/Ctn
30311611	16x11	2,0	4
30311812	18x12	3,0	4
30312013	20x13	4,1	4
30312214	22x14	5,3	4
30312415	24x15	6,8	4
30312817	28x17	10,5	2
30313020	30x20	14,1	2
30313219	32x19	15,3	2
30313622	36x22	22,4	1
30314025	40x25	32,0	1
30314522	45x22	35,0	1
30316025	60x25	70,0	1

16



### » Orta Sığ Tencere

Shallow Casseroles

Kod Code	Øxh (cm) Øxh (cm)	Lt Lt	Koli/Adet Pcs/Ctn
30311607	16x7	1,4	4
30311808	18x8	2,0	4
30312009	20x9	3,0	4
30312210	22x9,5	3,6	4
30312411	24x10,5	5,0	4
30312812	28x12	7,4	4
30313015	30x12	8,4	2
30313215	32x15	12,1	2
30313617	36x17	17,3	2
30314019	40x19	25,0	1
30315019	50x20	39,0	1

### » Sığ Tencere

Shallow Stew Pan

Kod Code	Øxh (cm) Øxh (cm)	Lt Lt	Koli/Adet Pcs/Ctn
30312475	24x7,5	3,5	4
30312807	28x7	4,3	4
30313208	32x7,5	6,0	2
30313608	36x8	8,1	2
30314008	40x8	10,0	2
30314510	45x10	15,9	1
30315010	50x10	20,0	1
30316010	60x10	28,3	1



CERAMIC

ELECTRIC

INDUCTION

GAS

DISHWASHER



## » Kapaklar

Lids

Kod Code	Ø (cm) Ø (cm)	Koli/Adet Pcs/Ctn
30212116	16	4
30212118	18	4
30212120	20	4
30212124	24	4
30212128	28	2
30212130	30	2
30212132	32	2
30212136	36	2
30212140	40	1
30212145	45	1
30212150	50	1
30212160	60	1



## » Konveks Kapaklar

Convex Lids

Kod Code	Ø (cm) Ø (cm)	Koli/Adet Pcs/Ctn
30210116	16	4
30210118	18	4
30210120	20	4
30210122	22	4
30210124	24	4
30210128	28	2
30210130	30	2
30210132	32	2
30210136	36	2
30210140	40	1
30210145	45	1
30210150	50	1
30210160	60	1



## » Çorbalık (Gömme)

Soup Pot (Built-in)

Kod Code	Øxh (cm) Øxh (cm)	Lt Lt	Koli/Adet Pcs/Ctn
35522428	24x28 (Tabanlı/w/base)	12,5	2
35522828	28x28 (Tabanlı/w/base)	17,2	2
35523232	32x32 (Tabanlı/w/base)	26,0	1
35503637	36x36 (Tabanlı/w/base)	36,6	1
35504050	40x40 (Tabanlı/w/base)	50,0	1
35505051	50x50 (Tabanlı/w/base)	100	1
35506055	60x55 (Tabanlı/w/base)	155	1
35522400	24x28 (Tabansız/w/o base)	12,5	2
35522800	28x28 (Tabansız/w/o base)	17,2	2
35523200	32x32 (Tabansız/w/o base)	26,0	1
35503600	36x36 (Tabansız/w/o base)	36,6	1
35504000	40x40 (Tabansız/w/o base)	50,0	1
35505000	50x50 (Tabansız/w/o base)	100	1
35506000	60x55 (Tabansız/w/o base)	155	1

## Helvane Tencereler / Wide Shallow Pots

### » Helvane Tencereler (Kapaklı)

Wide Shallow Pots w/Lid

Kod Code	Øxh (cm) Øxh (cm)	Lt Lt	Koli/Adet Pcs/Ctn
30013015	30x15	13	4
30013615	36x15	16	4
30013620	36x20	21	4
30014017	40x17	24	3
30014520	45x20	29	2
30015020	50x20	36	2
30015520	55x20	40	2
30016020	60x20	45	2
30016025	60x25	65	1
30016525	65x25	75	1
30017030	70x30	108	1
30018030	80x30	136	1
30019030	90x30	166	1
30010035	100x35	258	1
30011035	110x35	289	1



18

### » Helvane Kapaklar

Wide Shallow Lids

Kod Code	Ø (cm) Ø (cm)	Koli/Adet Pcs/Ctn
30210300	30	2
30210360	36	2
30210400	40	2
30210450	45	2
30210500	50	2
30210550	55	2
30210600	60	2
30210650	65	1
30210700	70	1
30210800	80	1
30210900	90	1
30210100	100	1
30210110	110	1





» Kuskus Tencere Süzgeci  
Couscous Colander

Kod Code	Øxh (cm) Øxh (cm)	Koli/Adet Pcs/Ctn
35664032	40x24	1
35665040	50x24	1
35666045	60x24	1

» Kuskus Tencere Seti (Kapaklı)  
Couscous Set (w/lid)

Kod Code	Øxh (cm) Øxh (cm)	Lt Lt	Koli/Adet Pcs/Ctn
35614032	A 40x24 B 32x32	30	1
35615040	A 50x24 B 40x40	47	1
35616045	A 60x24 B 45x45	65	1
35616050	A 60x24 B 50x50	65	1



» Makarna Piřirme Süzgeci  
Pasta Colander

Kod Code	Özellik Description	Koli/Adet Pcs/Ctn
36302420	24x19,5 Tencere ile uyumludur / Suitable for 24x19,5 Pot	3
36303623	36x22 Tencere ile uyumludur / Suitable for 36x22 Pot	4
36304026	40x25 Tencere ile uyumludur / Suitable for 40x25 Pot	4

» Makarna Piřirme Süzgeci Set  
Pasta Colander Set

Kod Code	Øxh (cm) Øxh (cm)	Lt Lt	Koli/Adet Pcs/Ctn
36312420	24x19,5 (3 Süzgeçli/ 3 Colanders)	8,0	1
36313623	36x22 (4 Süzgeçli/4 Colanders)	22,4	1
36314026	40x25 (4 Süzgeçli/4 Colanders)	32,0	1

\* Fiyatlara kapak dahildir. / Lid is included in the price.



## Paslanmaz Çelik Tavalar

- Paslanmaz çelik gövde
- Profesyonel kullanıma uygun ısıya dayanıklı paslanmaz çelik saplar
- Impact teknolojisi ile imal edilmiş 3 kat sandviç taban
- Her kullanıma uygun ölçü seçenekleri
- Mükemmel ısı dağılımı
- Saten yüzey
- İndüksiyon ocaklara uygundur

## Stainless Steel Pans

- Stainless steel 18/10 body
- Heat resistant stainless steel professional handles
- Impact bonded sandwich bottom
- Multiple size options for various cooking
- Even heat distribution
- Satin finishing
- Suitable for induction cookers





» Tek Saplı Tava  
Fry Pan

Kod Code	Øxh (cm) Øxh (cm)	Lt Lt	Koli/Adet Pcs/Ctn
30152004	20x5	1,6	4
30152405	24x5,5	2,5	4
30152806	28x6	3,7	4
30153206	32x7	6,0	1
30153606	36x7	8,1	1
30154007	40x8	10,1	1

\* Ø32, Ø36, Ø40 Destek sap ilavedir  
\* Ø32, Ø36, Ø40 w/helper handle

» Tek Saplı Yapışmaz Çelik Tava  
Non-Stick Coated Fry Pan

Kod Code	Øxh (cm) Øxh (cm)	Lt Lt	Koli/Adet Pcs/Ctn
30342004	20x5	1,6	4
30342405	24x5,5	2,5	4
30342805	28x6	3,7	4
30343207	32x7	6,0	1
30343608	36x7	8,1	1
30344008	40x8	10,1	1

\* Ø32, Ø36, Ø40 Destek sap ilavedir  
\* Ø32, Ø36, Ø40 w/helper handle

\* İndüksiyon ocaklarda kullanılmaz.  
\* Not suitable for induction



» Derin Tava (Balık Tava)  
Saute Pan

Kod Code	Øxh (cm) Øxh (cm)	Lt Lt	Koli/Adet Pcs/Ctn
30452004	20x5	1,6	4
30452405	24x5,5	2,5	4
30452805	28x8	3,7	4
30453207	32x7,5	6,0	2
30453606	36x8	8,1	1

21



» Çift Saplı Tava (Paella)  
Paella Pan

Kod Code	Øxh (cm) Øxh (cm)	Lt Lt	Koli/Adet Pcs/Ctn
30362004	20x5	1,6	4
30362405	24x5,5	2,5	4
30362806	28x6	3,7	2
30363207	32x6,5	6,0	2
30363608	36x7,5	8,1	2
30364008	40x8	10,1	2



» Sahanlar  
French Omelette Pan

Kod Code	Øxh (cm) Øxh (cm)	Koli/Adet Pcs/Ctn
30315014	14x3	10
30315016	16x3	10
30315018	18x3	8
30315020	20x3	8
30315022	22x3	6
30315024	24x3	6
30315028	28x3	2
30315032	32x3	2



» Helvane Tava  
Wide Shallow Pan w/o Lid

Kod Code	Øxh (cm) Øxh (cm)	Lt Lt	Koli/Adet Pcs/Ctn
30323008	30x8	5,0	3
30323609	36x9	9,0	3
30324012	40x12	15,7	2
30324512	45x12	19,0	2
30325012	50x12	23,0	2
30326014	60x14	34,0	1
30327015	70x14	53,5	1
30328016	80x16	73,0	1

\* İndüksiyon ocaklarda kullanılmaz.  
\* Not suitable for induction







» Derin Kaçarola  
Deep Sauce Pan

Kod Code	Øxh (cm) Øxh (cm)	Lt Lt	Koli/Adet Pcs/Ctn
30150008	16x11	2	6
30150004	18x12	3	4
30150005	20x13	4,1	4
30150019	22x14	5,3	2
30150006	24x15	6,8	2
30150020	28x17	10,5	2
30150021	30x12	8,4	2
30150030	32x15	12,1	2

\*Ø28, Ø30, Ø32 Destek sap ilavedir

\*Ø28, Ø30, Ø32 w/helper handle support



» Sığ Kaçarola  
Shallow Sauce Pan

Kod Code	Øxh (cm) Øxh (cm)	Lt Lt	Koli/Adet Pcs/Ctn
30150007	12x6	0,7	6
30150010	14x7	1,1	6
30150015	16x7	1,4	6
30150018	18x8	2,0	4
30150017	20x9	3,0	4
30150016	22x9,5	3,6	2
30150014	24x10,5	5,0	2



» Tabansız Kaçarola  
Sauce Pan without Sandwich Bottom

Kod Code	Øxh (cm) Øxh (cm)	Lt Lt	Koli/Adet Pcs/Ctn
30381206	12x6	0,7	6
30381407	14x7	1,1	6
30381607	16x7	1,4	6
30381611	16x11	2,2	6
30381809	18x8	2,0	4
30381812	18x12	3,1	4
30382010	20x9	3,2	4
30382013	20x13	4,1	4
30382411	24x10,5	5,0	2
30382415	24x15	6,8	2
30382814	28x14	7,6	2

\* Pişirme amaçlı kullanılmaz.

\* Not suitable for cooking

23



» Yapışmaz Sote Tava  
Non-stick Coated Conical Saute Pan

Kod Code	Øxh (cm) Øxh (cm)	Lt Lt	Koli/Adet Pcs/Ctn
30331605	16x6	0,75	4
30331805	18x6,5	1,0	4
30332005	20x7	1,9	2
30332405	24x8	2,5	2

\* İndüksiyon ocaklarda kullanılmaz.

\* Not suitable for induction



» Sote Tava  
Conical Saute Pan

Kod Code	Øxh (cm) Øxh (cm)	Lt Lt	Koli/Adet Pcs/Ctn
30431606	16x6	0,75	4
30431806	18x6,5	1,0	4
30432006	20x7	1,9	2
30432406	24x8	2,5	2



» Sote Tava (Çift Dökme Ağızlı)  
Conical Saute Pan w/Double Spouts

Kod Code	Øxh (cm) Øxh (cm)	Lt Lt	Koli/Adet Pcs/Ctn
30351606	16x6	0,75	4
30351806	18x6,5	1,0	4
30352007	20x7	1,9	2
30352408	24x8	2,5	2



- Özel 3003 alaşım 3 mm kalınlığında alüminyum gövde
- Yapışmaz teflon kaplama
- Profesyonel kullanıma uygun paslanmaz çelik saplar
- Doğa dostu: PFOA içermez
- İndüksiyon ocaklara uygundur
- Made from Special 3003 alloy aluminium
- Non-stick Teflon Coating
- Stay Cool Stainless Steel Pipe Handles with professional riveting fixing
- Eco-Friendly: PFOA Free
- Suitable for induction



24

## Alüminyum Tavalar Aluminum Non Stick Pans



» Yapışmaz Alüminyum Kızartma Tava  
Aluminum Non Stick Fry Pan

Kod Code	Ø (cm) Ø (cm)	Koli/Adet Pcs/Ctn
12021020	20	6
12021024	24	6
12021028	28	6
12021032	32	6
12021036	36	6
12021040	40	6



» Yapışmaz Alüminyum Wok Tava  
Aluminum Non Stick Wok Pan

Kod Code	Ø (cm) Ø (cm)	Koli/Adet Pcs/Ctn
12144024	24	6
12144028	28	6
12144030	30	6



» Yapışmaz Alüminyum Krep Tava  
Aluminum Non Stick Crepe Pan

Kod Code	Ø (cm) Ø (cm)	Koli/Adet Pcs/Ctn
12123024	24	6
12123028	28	6



- Bakteri oluşumunu önleyen üç kat emaye ile kaplıdır
- Buhar tutucu özel kapak tasarımı sayesinde vitamin ve mineral kaybını önler
- Isıyı hızla emer, uzun süre muhafaza eder
- Mükemmel iletkenliği ve eşit ısı dağılımı ile enerji tasarrufu sağlar
- Kesilme ve çizilmeye karşı dayanıklı yüzey metal ekipmanları kullanabilme rahatlığı sağlar
- Her tür ocak ve fırında kullanılabilme özelliği
- Yapışmaz, kolay temizlenebilir



- Triple enamel coating that ensures hygiene
- Vapor binding cover, prevents the loss of vitamins and minerals
- It absorbs heat rapidly and protects it for a long time
- Also good for food presentation at buffets
- Energy saving is provided by perfect thermal conductivity and balanced heat distribution
- Cut and scratch resistant surface provides the convenience of using metal equipments
- Suitable for all kinds of energy hobs and ovens
- Non – stick, easy to clean



### » Mini Tencere / Mini Pot

Kod Code	Model Model	Øxh (cm) Øxh (cm)	Lt Lt	Koli/Adet Pcs/Ctn
48011110	Tencere/ Pot	10	0,35	1
48013110	Altılık/ Wooden Base			1
48014110	3'lü Altılık /Wooden Base for 3 Pots			1



480 481 482



### » Tencere / Pot

Kod Code	Model Model	Øxh (cm) Øxh (cm)	Lt Lt	Koli/Adet Pcs/Ctn
48011120	Tencere/Pot	20	2,56	1
48013120	Altılık/ Wooden Base			1
48011124	Tencere/ Pot	24	4,93	1
48013124	Altılık/ Wooden Base			1
48011128	Tencere/ Pot	28	6,80	1
48013128	Altılık/ Wooden Base			1



480 481 482

25



### » Yayvan Tencere / Shallow Pot

Kod Code	Model Model	Øxh (cm) Øxh (cm)	Lt Lt	Koli/Adet Pcs/Ctn
48011424	Tencere/ Pot	24	2,40	1
48013424	Altılık/ Wooden Base			1
48011428	Tencere/ Pot	28	3,40	1
48013428	Altılık/ Wooden Base			1



480 481 482

## Döküm Tavalara /Cast Iron Pans



### » Döküm Tepsi

Cast Iron Grill Tray Pan

Kod Code	Model Model	Ölçü (cm) Dims. (cm)	Koli/Adet Pcs/Ctn
48012230	Tava/Pan	22x30	1
48022230	Altılık/Wood Base		1
48012640	Tava/Pan	26x40	1
48022640	Altılık/Wood Base		1



480

481

482

### » Döküm Yuvarlak Tava

Cast Iron Round Pan

Kod Code	Model Model	Ø (cm) Ø (cm)	Koli/Adet Pcs/Ctn
48010016	Tava/Pan	16	1
48020016	Altılık/Wood Base		1
48010020	Tava/Pan	20	1
48020020	Altılık/Wood Base		1
48021016	Seramik Sos Kabı Ceramic Sauce Cup		3

### » Döküm Izgara Tava

Cast Iron Rectangular Grill Pan

Kod Code	Model Model	Ölçü (cm) Dims. (cm)	Koli/Adet Pcs/Ctn
48012647	Tava/Pan	26x47	1
48022647	Altılık/Wood Base		1

26



### » Döküm Fajita Tavası

Cast Iron Fajita Pan

Kod Code	Model Model	Ölçü (cm) Dims. (cm)	Koli/Adet Pcs/Ctn
48011824	Tava/Pan	18,5x24,5	1
48021824	Altılık/Wood Base		1
48011529	Tava/Pan	15x29,5	1
48021529	Altılık/Wood Base		1

### » Döküm Balık Tavası

Cast Iron Fish Pan

Kod Code	Model Model	Ölçü (cm) Dims. (cm)	Koli/Adet Pcs/Ctn
48011524	Tava/Pan	15x24,5	1
48021524	Altılık/Wood Base		1

### » Döküm Sac Kavrurma Tavası

Cast Iron Sheet Roasting Pan

Kod Code	Model Model	Ø (cm) Ø (cm)	Koli/Adet Pcs/Ctn
48018020	Tava/Pan	20	1
48028020	Altılık/Wood Base		1
48018028	Tava/Pan	28	1
48028028	Altılık/Wood Base		1



### » Döküm Pizza-Krep-Pankek Tava

Cast Iron Pizza-Crep-Pankek Pan

Kod Code	Model Model	Ø (cm) Ø (cm)	Koli/Adet Pcs/Ctn
48011220	Tava/Pan	20	1
48021220	Altılık/Wood Base		1
48011227	Tava/Pan	28	1
48021228	Altılık/Wood Base		1



» Döküm Izgara Tava (Porsiyonluk)  
Cast Iron Grill Pan (1 Portion)

Kod Code	Model Model	Ölçü (cm) Dims. (cm)	Koli/Adet Pcs/Ctn
48011616	Tava/Pan	16x16	1
48021616	Altılık/Wood Base		1



» Döküm Mini Izgara Tava  
Cast Iron Mini Grill Pan

Kod Code	Model Model	Ölçü (cm) Dims. (cm)	Koli/Adet Pcs/Ctn
48011522	Tava/Pan	15x22	1
48021522	Altılık/Wood Base		1



» Döküm Kare Izgara Tava  
Cast Iron Square Grill Pans

Kod Code	Model Model	Ölçü (cm) Dims. (cm)	Koli/Adet Pcs/Ctn
48012626	Tava/Pan	26x26	1
48022626	Altılık/Wood Base		1



» Döküm Yarı Düz Izgara Tava  
Cast Iron Semi Grill/Semi Flat Pan

Kod Code	Model Model	Ölçü (cm) Dims. (cm)	Koli/Adet Pcs/Ctn
48002632	Tava/Pan	26x32	1
48022732	Altılık/Wood Base		1



» Döküm Izgara Yüzey Dörtgen Tava  
Cast Iron Ribbed Skillet

Kod Code	Model Model	Ölçü (cm) Dims. (cm)	Koli/Adet Pcs/Ctn
48032632	Tava/Pan	26x32	1
48042632	Altılık/Wood Base		1



480

481

482



» Döküm Izgara Yüzey Tava  
Cast Iron Ribbed Frying Pan

Kod Code	Model Model	Ø (cm) Ø (cm)	Koli/Adet Pcs/Ctn
48011228	Tava/Pan	28	1
48013228	Altılık/Wood Base		1



480

481

482



» Döküm Düz Yüzey Tava  
Cast Iron Frying Pan

Kod Code	Model Model	Ø (cm) Ø (cm)	Koli/Adet Pcs/Ctn
48011328	Tava/Pan	28	1
48013328	Altılık/Wood Base		1



480

481

482



» Döküm Sahan  
Cast Iron French Omelette Pan

Kod Code	Model Model	Ø (cm) Ø (cm)	Koli/Adet Pcs/Ctn
48111322	Tava/Pan	22	1
48013322	Altılık/Wood Base		1

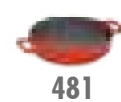

481

Roasteasy

- İçi daha yumuşak dışı daha çıtır et, tavuk, balık ve sebzeleriniz için ideal pişirme
- Patentli formül sayesinde nemi koruyarak küçülmeden, kurumadan yeterli miktarda havayla temas ederek mükemmel kızarma ve çıtırılık sağlar
- Zincirin delikleri sayesinde pişirme esnasında yemeği rahatça soslayabilme
- Yemeği fırından çıkarttıktan sonra dinlendirme esnasında sıcak tutar
- Pişirme esnasında çelik ısıyı eşit iletir bu sayede hiç bir bölge çiğ kalmaz
- Elde ve bulaşık makinesinde yıkanabilir
- Gıdalla temasa uygun yüksek kalite çelikten üretilmiştir (NF A36-711)
- Çevre dostu

- Measuring 40x40 cm Roasteasy covers the largest chicken or smaller size roast joint
- Great alternative to tinfoil
- Allows venting and not sweating
- Allows perfect browning and crisping
- Reduces burning
- Roasteasy can be used during or after cooking
- Ideal for use in convection ovens
- Ideal for cooking meats, chicken or fish
- Can be used for barbecuing steaks & prawns also be used as an ideal diffuser on the barbecue
- Reduces shrinkage
- Retains natural juices and enhances flavours
- Maintains texture and shape for perfect carving
- Roasteasy is a reusable lifetime product
- Stays warm allowing your roast to rest & relax without losing its heat
- Roasteasy is dishwasher proof, easy-clean and reduces fat spit and spray in oven interiors



» Paslanmaz Çelik Pişirme Örtüsü  
Stainless Steel Roasteasy

Kod Code	Ölçü Dimensions	Koli/Adet Pcs/Ctn
65620001	40x40	1



## Fırın Tepsileri / Roasting Pans



### » Kapaklı Tepsi

Roasting Pan w/Clip-on Cover

Kod Code	Ölçü Dims. (cm)	Koli/Adet Pcs/Ctn
30714565	40x60x5	2
30714568	40x60x8	2
30714561	40x60x10	2
30715355	50x35x5	2
30715358	50x35x8	2
30715310	50x35x10	2
30715705	50x70x5	2
30715708	50x70x8	2
30715710	50x70x10	2

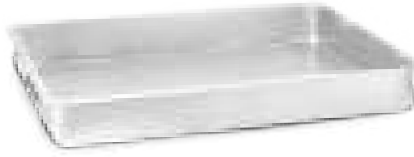

### » Kapaksız Tepsi

Tapered Roasting Pan

Kod Code	Ölçü Dims. (cm)	Koli/Adet Pcs/Ctn
30704565	40x60x5	2
30704568	40x60x8	2
30704561	40x60x10	2
30705355	50x35x5	2
30705358	50x35x8	2
30705310	50x35x10	2
30705705	50x70x5	3
30705708	50x70x8	3
30705710	50x70x10	3



### » Kapak

Cover

Kod Code	Ölçü Dims. (cm)	Koli/Adet Pcs/Ctn
30705711	40x60	1
30705713	50x35	1
30705712	50x70	1



### » Yapışmaz Kaplı GN Fırın Tepsisi (S/S)

Nonstick GN Roasting Pan (S/S)

Kod Code	Ölçü(mm) Dims. (mm)	Lt Lt	Koli/Adet Pcs/Ctn
31311020	1/1-20	2,5	5
31321020	2/1-20	5	5



### » Yapışmaz GN Fırın Tepsisi (Alüminyum)

Nonstick GN Roasting Pan (Aluminum)

Kod Code	Ölçü(mm) Dims. (mm)	Lt Lt	Koli/Adet Pcs/Ctn
31311030	1/1-20	2,5	5
33121030	2/1-20	5	5

29



### » Yuvarlak Tepsi

Round Roasting Pan (S / S)

Kod Code	Øxh (cm) Øxh (cm)	Koli/Adet Pcs/Ctn
30703805	36x5	4
30704505	45x5	4
30705005	50x5	2
30706005	60x5	2



### » Alüminyum Pizza Tepsisi

Aluminium Pizza Tray

Kod Code	Ø (cm) Ø (cm)	Koli/Adet Pcs/Ctn
43010018	18	4
43010020	20	4
43010022	22	4
43010024	24	4
43010026	26	2
43010028	28	2
43010030	30	2
43010032	33	2
43010040	40	2







**Hazırlık/Preparing**





## Gastronorm Küvet Özellikleri

- ° Kuvvetlendirilmiş köşeler
- ° 2/1 - 1/9 aralığında geniş ölçü seçeneği
- ° 20-200 mm aralığında derinlik seçeneği
- ° Standart GN, saplı GN, ve delikli GN çeşitleri
- ° Standart, kepe delikli ve sızdırmaz contalı kapak çeşitleri
- ° İstiflenebilir
- ° Hazırlık, dondurma, depolama, yeniden ısıtma, ve servis için uygun

## GN Food Pan Specs

- ° Reinforced Edges
- ° Sizes from 2/1 to 1/9
- ° 20-200 mm Depth
- ° Standard, Handled and Perforated Types
- ° Standard, Notched and Sealed Lid Types
- ° Stackable
- ° Suitable for Preparing, Freezing, Storage, Reheating and Serving

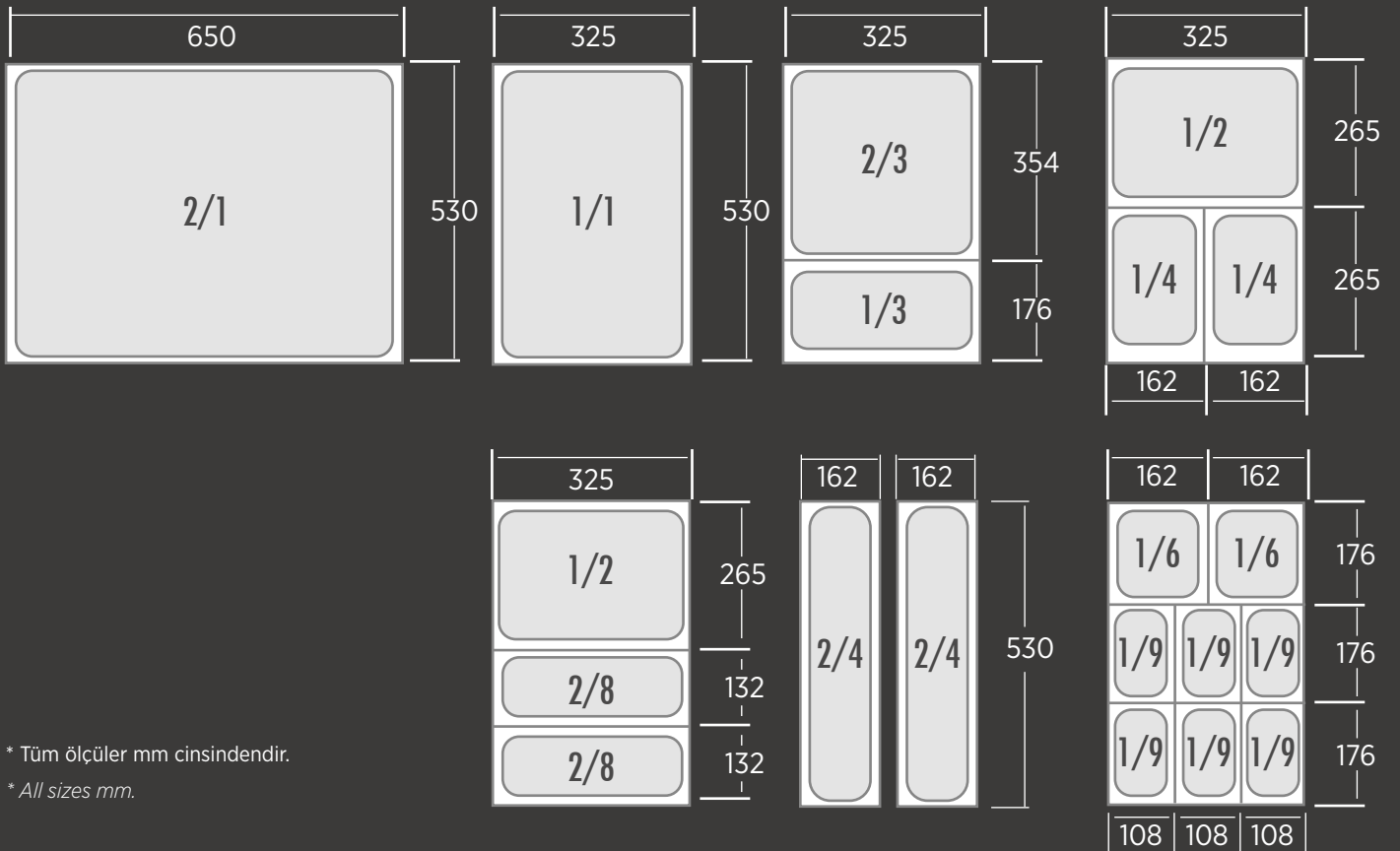

\* Tüm ölçüler mm cinsindedir.





\* All sizes mm.

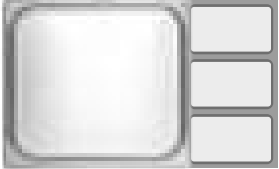

Standart Gastronorm Kvetler  
GN Food Pans

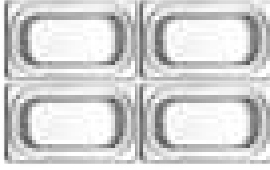
		Kod Code	Derinlik (mm) Depth (mm)	Lt Lt	Koli/Adet Pcs/Ctn
	<b>2/1</b> 650x530	31021010	10	2,5	10
		31021020	20	5,0	10
		31021040	40	10,0	10
		31021065	65	18,5	10
		31021100	100	28,5	5
		31021150	150	42,5	5
		31021200	200	57,5	3
	<b>1/1</b> 530x325	31011010	10	1,25	20
		31011020	20	2,5	20
		31011040	40	5,0	20
		31011065	65	9,0	11
		31011100	100	14,0	10
		31011150	150	21,0	10
		31011200	200	28,0	8
	<b>2/3</b> 354x325	31023020	20	1,5	20
		31023040	40	3,0	20
		31023065	65	5,5	20
		31023100	100	9,0	20
		31023150	150	13,0	15
		31023200	200	18,0	10
	<b>1/2</b> 325x265	31012020	20	1,25	25
		31012040	40	2,0	30
		31012065	65	4,0	30
		31012100	100	6,5	25
		31012150	150	9,5	13
		31012200	200	12,5	10
	<b>1/3</b> 325x176	31013020	20	0,75	30
		31013040	40	1,5	40
		31013065	65	2,5	40
		31013100	100	4,0	30
		31013150	150	5,7	30
		31013200	200	7,8	20

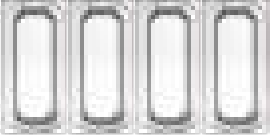
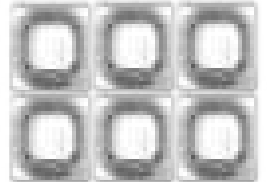

Standart Gastronorm Kvetler GN Food Pans			Kod Code	Derinlik (mm) Depth (mm)	Lt Lt	Koli/Adet Pcs/Ctn
	<b>1/4</b> 265x162	31014020	20	0,5	30	
		31014040	40	1,0	30	
		31014065	65	1,8	30	
		31014100	100	2,8	30	
		31014150	150	4,0	30	
		31014200	200	5,5	20	
	<b>2/4</b> 530x162	31024020	20	0,5	20	
		31024040	40	1,3	18	
		31024065	65	2,3	16	
		31024100	100	5,2	14	
	<b>2/8</b> 325x132	31028065	65	1,0	10	
		31028100	100	2,0	10	
	<b>1/6</b> 176x162	31016065	65	1,0	40	
		31016100	100	1,6	40	
		31016150	150	2,4	30	
		31016200	200	3,4	20	
	<b>1/9</b> 176x108	31019065	65	0,6	20	
		31019100	100	1,0	20	

Süzgeçli Gastronorm Küvetler  
Perforated GN Food Pans



		Kod Code	Derinlik (mm) Depth (mm)	Koli/Adet Pcs/Ctn
	<b>2/1</b> 650x530	30921020	20	10
		30921040	40	10
		30921065	65	10
		30921100	100	5
		30921150	150	5
		30921200	200	3
	<b>1/1</b> 530x325	30911020	20	20
		30911040	40	20
		30911065	65	11
		30911100	100	10
		30911150	150	10
		30911200	200	8
	<b>2/3</b> 354x325	30923020	20	20
		30923040	40	20
		30923065	65	20
		30923100	100	20
		30923150	150	15
		30923200	200	10
	<b>1/2</b> 325x265	30912020	20	25
		30912040	40	30
		30912065	65	30
		30912100	100	25
		30912150	150	13
		30912200	200	10

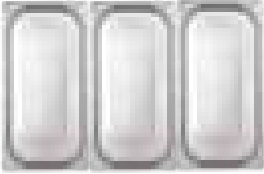
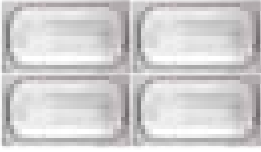
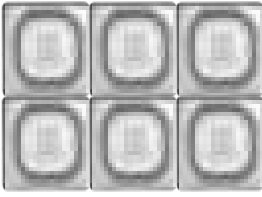

Süzgeçli Gastronorm Küvetler  
Perforated GN Food Pans

		Kod Code	Derinlik (mm) Depth (mm)	Koli/Adet Pcs/Ctn
	<b>1/3</b> 325x176	30913020	20	30
		30913040	40	40
		30913065	65	40
		30913100	100	30
		30913150	150	30
		30913200	200	20
	<b>1/4</b> 265x162	30914020	20	30
		30914040	40	30
		30914065	65	30
		30914100	100	30
		30914150	150	30
		30914200	200	20
	<b>1/6</b> 176x132	30916065	65	40
		30916100	100	40
		30916150	150	30
		30916200	200	20



## Saplı Gastronorm Kvetler / GN Food Pans w/Handle



Saplı Gastronorm Kvetler  
GN Food Pans w/Handle

		Kod Code	Derinlik (mm) Depth (mm)	Lt Lt	Koli/Adet Pcs/Ctn
	<b>2/1</b> 650x530	31121065	65	18,5	10
		31121100	100	28,5	5
		31121150	150	42,5	5
		31121200	200	57,5	3
	<b>1/1</b> 530x325	31111065	65	9,0	11
		31111100	100	14,0	10
		31111150	150	21,0	10
		31111200	200	28,0	8
	<b>2/3</b> 354x325	31123065	65	5,5	20
		31123100	100	9,0	20
		31123150	150	13,0	15
		31123200	200	18,0	10
	<b>1/2</b> 325x265	31112065	65	4,0	30
		31112100	100	6,5	25
		31112150	150	9,5	13
		31112200	200	12,5	10

Saplı Gastronorm Kvetler  
GN Food Pans w/Handle

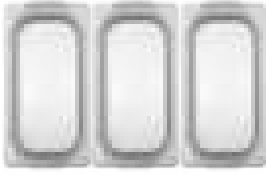
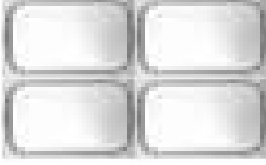
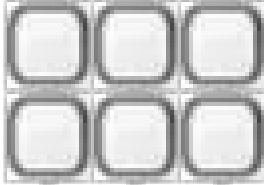

		Kod Code	Derinlik (mm) Depth (mm)	Lt Lt	Koli/Adet Pcs/Ctn
	<b>1/3</b> 325x176	31113065	65	2,5	40
		31113100	100	4,0	30
		31113150	150	5,7	30
		31113200	200	7,8	20
	<b>1/4</b> 265x162	31114065	65	1,8	30
		31114100	100	2,8	30
		31114150	150	4,0	30
		31114200	200	5,5	20
	<b>1/6</b> 176x162	31116065	65	1,0	40
		31116100	100	1,6	40
		31116150	150	2,4	30
		31116200	200	3,4	20



**NEW**



» Sızdırmaz Contalı 1/1

Lid w/Hermetic Seal 1/1

Kod Code	Model Model	Ölçü (mm) Dim (mm)	Koli/Adet Pcs/Ctn
32023311	1/1	530x325	15



» Sızdırmaz Contalı

Lid w/Hermetic Seal

Kod Code	Model Model	Ölçü (mm) Dim (mm)	Koli/Adet Pcs/Ctn
31923312	1/2	325x265	15
31923313	1/3	325x176	15
31923314	1/4	265x162	20



» Standart

Standart

Kod Code	Model Model	Ölçü (mm) Dim (mm)	Koli/Adet Pcs/Ctn
31921530	2/1	650x530	15
31911325	1/1	530x325	15
31923325	2/3	354x325	20
31924300	2/4	530x162	12
31928300	2/8	325x132	12
31912265	1/2	325x265	30
31913176	1/3	325x176	30
31914162	1/4	265x162	30
31916162	1/6	176x162	30
31919108	1/9	176x108	30

» Sap Delikli

Lid w/Handle Hole

Kod Code	Model Model	Ölçü (mm) Dim (mm)	Koli/Adet Pcs/Ctn
32100021	2/1	650x530	6
32100011	1/1	530x325	6
32100023	2/3	354x325	6
32100012	1/2	325x265	6
32100013	1/3	325x176	6
32100014	1/4	265x162	6
32100016	1/6	176x162	12

» Kepçe Delikli

Lid w/Ladle Hole

Kod Code	Model Model	Ölçü (mm) Dim (mm)	Koli/Adet Pcs/Ctn
32100121	2/1	650x530	6
32100111	1/1	530x325	6
32100123	2/3	354x325	6
32100112	1/2	325x265	6
32100113	1/3	325x176	6
32100114	1/4	265x162	6
32100116	1/6	176x162	12



plast|port®  
by KAPP

» PC Sızdırmaz Contalı (PC GN Küvet uyumlu)  
PC Lid w/Hermetic Seal for PC GN Containers

Kod Code	Model Model	Ölçü (mm) Dim (mm)	Koli/Adet Pcs/Ctn
46011011	1/1	530x325	6
46011012	1/2	325x265	6

\* GN Küvet fiyata dahil değildir.

\* GN pan is not included in price

41

also available

BPA  
FREE



plast|port®  
by KAPP

» PC Sızdırmaz Contalı (Paslanmaz GN Küvet uyumlu)  
PC Lid w/Hermetic Seal for S/S GN Containers

Kod Code	Model Model	Ölçü (mm) Dim (mm)	Koli/Adet Pcs/Ctn
46012011	1/1	530x325	6

\* GN Küvet fiyata dahil değildir.

\* GN pan is not included in price

plast|port®  
by KAPP

» Polikarbonat GN Kapak  
PC GN Lid

Kod Code	Model Model	Ölçü (mm) Dim (mm)	Koli/Adet Pcs/Ctn
46010011	1/1	530x325	12
46010012	1/2	325x265	12
46010013	1/3	325x176	12
46010014	1/4	265x162	12
46010016	1/6	176x162	24
46010019	1/9	176x108	24

\* Paslanmaz Çelik GN Küvetler ile uyumludur.

\* Suitable for S/S GN pans.

## Bain Marie Kvetler / Bain Marie Containers

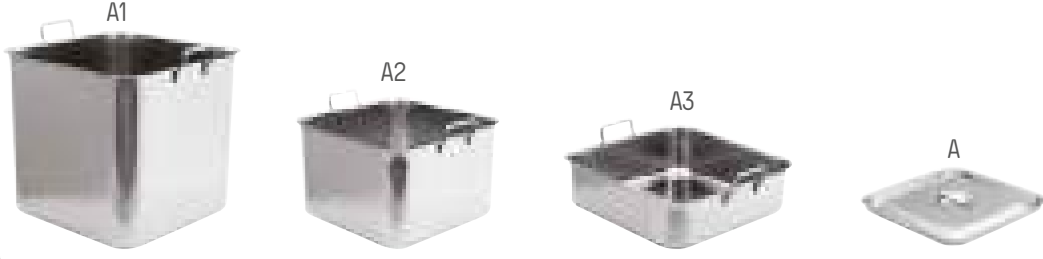

» A

A

Kod Code	Model Model	l (mm) Dim (mm)	h (mm) h (mm)	Lt Lt	Koli/Adet Pcs/Ctn
31622235	A1	240x240	235	13	6
31622160	A2	240x240	160	9	12
31622075	A3	240x240	75	4	16
31622300	A (Kapak / Lid)	240x240			20



» B

B

Kod Code	Model Model	l (mm) Dim (mm)	h (mm) h (mm)	Lt Lt	Koli/Adet Pcs/Ctn
31611235	B1	155x155	235	5	12
31611160	B2	155x155	160	3,5	12
31611075	B3	155x155	75	1,5	20
31611300	B (Kapak / Lid)	155x155			50



» C

C

Kod Code	Model Model	l (mm) Dim (mm)	h (mm) h (mm)	Lt Lt	Koli/Adet Pcs/Ctn
31610160	C2	155x105	160	2,5	20
31610075	C3	155x105	75	1,2	25
31610055	C4	155x105	55	0,8	30
31610300	C (Kapak / Lid)	155x105			75



» Dondurma Küveti  
GN Ice Cream Pan

Kod Code	Lt Lt	Ölçü (cm) Dim (cm)	Koli/Adet Pcs/Ctn
31236065	4	36x17x6,5	15
31236100	6,1	36x17x10	15
31236120	7,3	36x17x12	15
31236150	9,2	36x17x15	15



» PP Dondurma Küveti  
PP GN Ice Cream Pan

Kod Code	Lt Lt	Ölçü (cm) Dim (cm)	Koli/Adet Pcs/Ctn
46010002	4,5	36x17x11	12

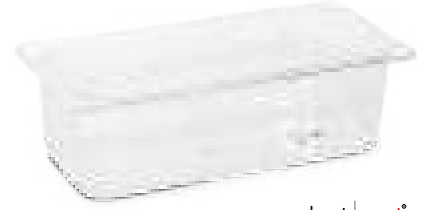

» PC Dondurma Küveti  
PC GN Ice Cream Pan

Kod Code	Lt Lt	Ölçü (cm) Dim (cm)	Koli/Adet Pcs/Ctn
46010001	4,5	36x17x11	12



» Meze Küveti  
Appetizer Pan

Kod Code	Ölçü (mm) Dim (mm)	Koli/Adet Pcs/Ctn
35011929	195x295x35	1
35012333	230x330x42	1
35012538	257x380x47	1
35012843	285x430x51	1



» Yapışmaz Kaplı GN Fırın Tepsisi (S/S)  
Nonstick GN Roasting Pan (S/S)

Kod Code	Ölçü (mm) Dims. (mm)	Lt Lt	Koli/Adet Pcs/Ctn
31311020	1/1-20	2,5	5
31321020	2/1-20	5	5



» Yapışmaz GN Fırın Tepsisi (Alüminyum)  
Nonstick GN Roasting Pan (Aluminum)

Kod Code	Ölçü (mm) Dims. (mm)	Lt Lt	Koli/Adet Pcs/Ctn
31311030	1/1-20	2,5	5
33121030	2/1-20	5	5

43



» PP Pizza Hamur Teknesi  
PP Dough Tray

Kod Code	Lt Lt	Ölçü (cm) Dim (cm)	Koli/Adet Pcs/Ctn
46010026	16,8	40x60x7,7	8



» GN 1/1 Porselen

GN 1/1 Porcelain Food Pan

Kod Code	Ölçü (mm) Dim (mm)	Koli/Adet Pcs/Ctn
70020101	530x325	1



» GN 1/2 Porselen

GN 1/2 Porcelain Food Pan

Kod Code	Ölçü (mm) Dim (mm)	Koli/Adet Pcs/Ctn
70020102	325x265	1



» GN 2/3 Porselen

GN 2/3 Porcelain Food Pan

Kod Code	Ölçü (mm) Dim (mm)	Koli/Adet Pcs/Ctn
70020203	354x325	1

44



» GN 1/3 Porselen

GN 1/3 Porcelain Food Pan

Kod Code	Ölçü (mm) Dim (mm)	Koli/Adet Pcs/Ctn
70020103	325x176	1



» Yuvarlak Porselen

Round Porcelain Food Pan

Kod Code	Ölçü (cm) Dim (cm)	Koli/Adet Pcs/Ctn
70020100	39x6,5	1



» Yuvarlak Bölmeli Porselen

Round Divided Porcelain Food Pan

Kod Code	Ölçü (cm) Dim (cm)	Koli/Adet Pcs/Ctn
70021100	39x6,5	1



» Yuvarlak Bölmeli Tepsi

Round Divided Food Pan (S/S)

Kod Code	Ölçü (cm) Dim (cm)	Koli/Adet Pcs/Ctn
70023100	38,5x38,5x6,5	1



» Yuvarlak Tepsi

Round Food Pan (S/S)

Kod Code	Ölçü (cm) Dim (cm)	Koli/Adet Pcs/Ctn
30703565	35x6,5	4





» Süzgeç Taban S/S  
Drainer Plate S/S

Kod Code	Ölçü (mm) Dim (mm)	Model Model	Koli/Adet Pcs/Ctn
80026565	465x265	1/1	4
80026523	285x265	2/3	4
80026520	265x220	1/2	4
80026515	265x115	1/3	4



» Süzgeç Taban Plastik  
Drainer Plate Plastic

Kod Code	Ölçü (mm) Dim (mm)	Model Model	Koli/Adet Pcs/Ctn
80036565	463x258x15	1/1 - PC	4
80036523	259x199x15	1/2 - PC	4
80036515	268x119x14	1/3 - PC	4
80046565	458 x255x15	1/1 - PP	4

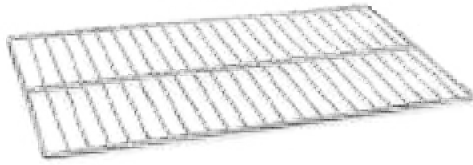

» Tel Izgara  
Wire Grid

Kod Code	Ölçü (mm) Dim (mm)	Model Model	Koli/Adet Pcs/Ctn
80022530	530x325	GN 1/1 (304-18/10)	12
80026530	650x530	GN 2/1 (304-18/10)	12
80025425	600x400	Tel Izgara/Wire Grid (304-18/10)	12
50701530	530x325	GN 1/1 (201-18/02)	12
50701650	650x530	GN 2/1 (201-18/02)	12
50701600	600x400	Tel Izgara/Wire Grid (201-18/02)	12



» Gastronom Süzgeç  
Colander for GN Pan

Kod Code	Koli/Adet Pcs/Ctn
30900000	1

\* GN Küvet fiyata dahil değildir.  
\* GN Pan not included in price.



» Sıcak Kap / GN Tutucu S/S  
S/S Grid for Hot Dishes

Kod Code	Koli/Adet Pcs/Ctn
62010041	6

\* GN Küvet fiyata dahil değildir.  
\* GN Pan not included in price.

» GN Destek Aparatı  
GN Adjustment Bar

Kod Code	Ölçü (mm) Dim (mm)	Model Model	Koli/Adet Pcs/Ctn
50020032	325	GN 1/1	4
80020053	530	GN 2/1	4

plast | port<sup>®</sup>  
by **KAPP**





### Polikarbonat Gastronom Küvetler

### Polycarbonate GN Pans

- Yüksek darbe dayanımına sahiptir, kırılmaz
- Yüksek darbe dayanımından dolayı köşe ve kenar deformasyonu yaşanmaz
- Asit dayanımı yüksektir, delinmez
- +100°C / - 40°C ısıya dayanıklıdır
- Mikrodalga fırın kullanımına uygundur
- İç içe istiflenebilir, yer tasarrufu sağlar
- Hafiftir, kolay taşınabilir
- İnsan sağlığına zararlı hammadde içermez
- Şeffaf yapısı sayesinde kullanım kolaylığı sağlar







- High impact resistance, unbreakable
- No corner and border deformation due to high impact resistance
- High acid-proof, impenetrable
- Heat endurance between +100°C /-40°C
- Suitable for microwave oven
- Stackable one within the other
- Light , easy to carry
- No hazardous substances on human health
- Easy to use due to the transparent structure



also available

Polikarbonat Őeffaf  
Gastronorm Kvetler  
Polycarbonate GN Pans

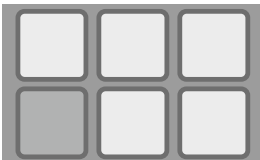

		Kod Code	Derinlik (mm) Depth (mm)	Koli/Adet Pcs/Ctn
	<b>1/1</b> 530x325	46011065	65	6
		46011100	100	6
		46011150	150	6
		46011200	200	6
	Kapak/ Lid	46010011		12
	<b>1/2</b> 325x265	46012065	65	12
		46012100	100	12
		46012150	150	12
		46012200	200	12
	Kapak/ Lid	46010012		12
	<b>1/3</b> 325x176	46013065	65	12
		46013100	100	12
		46013150	150	12
	Kapak/ Lid	46010013		12
		<b>1/4</b> 265x162	46014065	65
46014100			100	12
46014150			150	12
Kapak/ Lid		46010014		12
		<b>1/6</b> 176x162	46016065	65
	46016100		100	12
	46016150		150	12
	Kapak/ Lid	46010016		24
		<b>1/9</b> 176x108	46019065	65
46019100			100	12
46019150			150	12
Kapak/ Lid		46010019		24

also available

BPA  
FREE



Polikarbonat Siyah  
Gastronorm Küvetler  
Polycarbonate Black  
GN Pans

		Kod Code	Derinlik (mm) Depth (mm)	Koli/Adet Pcs/Ctn
	<b>1/1</b> 530x325	46111065	65	6
		46111100	100	6
		46111150	150	6
		46111200	200	6
	Kapak/ Lid	46010011		12
	<b>1/2</b> 325x265	46112065	65	12
		46112100	100	12
		46112150	150	12
		46112200	200	12
	Kapak/ Lid	46010012		12
	<b>1/3</b> 325x176	46113065	65	12
		46113100	100	12
		46113150	150	12
		Kapak/ Lid	46010013	
		<b>1/4</b> 265x162	46114065	65
46114100			100	12
46114150			150	12
Kapak/ Lid			46010014	
		<b>1/6</b> 176x162	46116065	65
	46116100		100	12
	46116150		150	12
	Kapak/ Lid		46010016	
		<b>1/9</b> 176x108	46119065	65
46119100			100	12
46119150			150	12
Kapak/ Lid			46010019	

## Polikarbonat Ölçülü Kare Saklama Kapları

### PC Square Food Storage Container w/Graduations

- Saklama, hazırlık, servis ve taşıma için idealdir
- Kırılmaz polikarbonattan imal edilmiştir
- Kırılmaz, çatlamaz, bükülmez ve çökme yapmaz
- 40° C' den 99° C' ye kadar dirençlidir
- Lt ve Qt ölçeği envanter düzeni için kullanışlıdır
- Kolay temizlenebilir

- Ideal for storing, preparing, serving display and transportation
- Made in unbreakable polycarbonate
- Nonbreakable, nonbending, can not be cracked or bent
- Withstand tempratures from 40° C to 99° C
- Useful for item layout in Lt and Qt
- Easy cleaning





» 18 Litre

18 Lt.

Kod Code	Ölçü (cm) Dim (cm)	Koli/Adet Pcs/Ctn
62030018	28,5x28,5x32	6



» 12 Litre

12 Lt.

Kod Code	Ölçü (cm) Dim (cm)	Koli/Adet Pcs/Ctn
62030012	28,5x28,5x21	6



» 8 Litre

8 Lt.

Kod Code	Ölçü (cm) Dim (cm)	Koli/Adet Pcs/Ctn
62030008	22,5x22,5x23	6



» 6 Litre

6 Lt.

Kod Code	Ölçü (cm) Dim (cm)	Koli/Adet Pcs/Ctn
62030006	22,5x22,5x19	6



» 3,8 Litre

3,8 Lt.

Kod Code	Ölçü (cm) Dim (cm)	Koli/Adet Pcs/Ctn
62030004	18,2x18,2x19	6



» 2 Litre

2 Lt.

Kod Code	Ölçü (cm) Dim (cm)	Koli/Adet Pcs/Ctn
62030002	18x18x10	6





» 1/1

1/1

Kod Code	Ölçü (mm) Dim (mm)	Koli/Adet Pcs/Ctn
46021065	1/1-65	6
46021100	1/1-100	6
46021150	1/1-150	6
46021200	1/1-200	6
46020011	Kapak/Lid	6

» 1/2

1/2

Kod Code	Ölçü (mm) Dim (mm)	Koli/Adet Pcs/Ctn
46022065	1/2-65	12
46022100	1/2-100	12
46022150	1/2-150	12
46022200	1/2-200	12
46020012	Kapak/Lid	12

» 1/3

1/3

Kod Code	Ölçü (mm) Dim (mm)	Koli/Adet Pcs/Ctn
46023065	1/3-65	12
46023100	1/3-100	12
46023150	1/3-150	12
46020013	Kapak/Lid	12

52



» 1/4

1/4

Kod Code	Ölçü (mm) Dim (mm)	Koli/Adet Pcs/Ctn
46024065	1/4-65	12
46024100	1/4-100	12
46024150	1/4-150	12
46021014	Kapak/Lid	12

» 1/6

1/6

Kod Code	Ölçü (mm) Dim (mm)	Koli/Adet Pcs/Ctn
46021665	1/6-65	12
46026100	1/6-100	12
46026150	1/6-150	12
46020016	Kapak/Lid	12

» 1/9

1/9

Kod Code	Ölçü (mm) Dim (mm)	Koli/Adet Pcs/Ctn
46029065	1/9-65	12
46029100	1/9-100	12
46029150	1/9-150	12
46020019	Kapak/Lid	12

- Çift amaçlı iç hazne; yüksek kapasiteli süzgeç / sebze kurutucu
- Kaymaz çevirme kolu
- Ayrılabilir kapak ile kolay temizleme
- Kullanım esnasında stabil gövde sağlayan tasarım
- Transparan kapak

- Dual purposed inner basket; high capacity colander / salad spinner
- Non-slip knob
- Take the lid apart to make it easy to clean
- Designed to remain stable during use
- Transparent lid

» Sebze Kurutucu  
Salad Spinner

Kod Code	Kapasite Capacity	Koli/Adet Pcs/Ctn
46700020	20 Lt	1

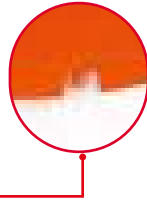

Gider bölgesi  
Drain compartment



53



- Kapak / Cover
- Şeffaf / Transparent
- Süzgeç / Filter
- Kova / Bucket



- 4 değişik kesim çeşidi (Dilimleme, Jülyen, Rende ve Zest)
- 1-10 mm arası ultra ince kesim kalınlığı
- Paslanmaz çelik sağlam ve profesyonel gövde
- V-şeklinde entegre bıçak
- Paslanmaz çelik yüksek kalite bıçaklar
- Plastik tutma aparatıyla güvenli kullanım
- Sebzeler için saklama kutusu ve hazne

- Multi-cuts : smooth slices, Juliennes, grate and zest
- Ultra-thin slices from 1 to 10 mm
- Robust and professional : in stainless steel
- V-shaped blade integrated
- Blades in pro quality stainless steel
- Complete safety thanks to the pusher
- Storage box and receptable for vegetables



**de BUYER**  
DEPUIS 1830

## » Mandolin Kesme Ünitesi

Mandoline

Kod  
Code

Koli/Adet  
Pcs/Ctn

63010025

1



Made in France



Dilim  
Slice



Çubuk  
Sticks



Jülyen  
Jullienne



Küp  
Dices

- S/S, hafif, kullanımı kolay
- Petek yapıli bıçak sayesinde hızlı ve hassas kesim
- GN1:1 veya 1:2 kaplarda kullanım için ideal (yatay kesimler)
- 2 bıçakla birlikte gelir (4 ve 10 mm) ve ergonomik iticiyle donatılmıştır.
- S/S, light weight, easy to handle
- Fast, precise cutting thanks to honeycombed blade
- Ideal for use on GN1:1 or 1:2 containers (horizontal cuts)
- Supplied with 2 blades (4 and 10mm) and ergonomic pusher

**NEW**

## » Mandolin 3 Bıçaklı Japanese Mandoline

Kod  
Code

Koli/Adet  
Pcs/Ctn

63010058

1



Dilim  
Slice



Çubuk  
Sticks



Jülyen  
Jullienne



Angel Hair  
Angel Hair

- 2, 3, 4 mm bıçaklar
- Jülyen kesim, dilimleme, çubuk kesim ve angel hair kesim
- Kağıt inceliğinde kesebilme özelliği
- Kolay temizlik için çıkarılabilir bıçak
- Ayarlanabilir kesim kalınlığı

- Comes w/3 interchangeable "comb" blades (2-3-4 mm) and a handle guard
- Exceptional cutting: Paper-thin and crispy slices of fruits and vegetables
- Removable blade for easy cleaning
- Adjustable cutting thickness



8 değişik jülyen kesim ve 4 değişik dilim kesim  
8 different julienne cuts and 4 different slice cuts

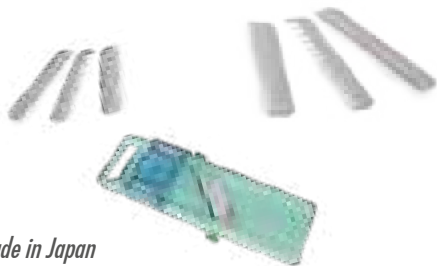

Made in Japan



Dilim  
Slice



Çubuk  
Sticks



Jülyen  
Jullienne



Angel Hair  
Angel Hair

## » Mandolin 3 Bıçaklı

Japanese Mandoline

Kod  
Code

Koli/Adet  
Pcs/Ctn

62050009

1



## » Çok Amaçlı Mandolin Kesici

Multi Functional Mandoline Slicer

Kod  
Code

Koli/Adet  
Pcs/Ctn

63010012

1



Dilim  
Slice



Dalgali  
Waffle



Çubuk  
Sticks



Jülyen  
Jullienne



*Made in France*



» Sebze Tornası (Le Rouet Gourmet)

Turning Slicer Le Rouet Gourmet w/3 Knives

Kod Code	Ölçü (cm) Dim. (cm)	Koli/Adet Pcs/Ctn
62050011	36x13,5x24,3	1



» Patates Dilimleme

French Fry Cutter

Kod Code	Ölçü (mm) Dim. (mm)	Koli/Adet Pcs/Ctn
41030003	9x9	1



» Ananas Soyma

Pineapple Peeler

Kod Code	Koli/Adet Pcs/Ctn
41030015	1



» Ananas Soyma

Pineapple Peeler

Kod Code	Koli/Adet Pcs/Ctn
41030005	1

- Özel kademeli bıçak tasarımı
- Kendinden yağlamalı itici sistem
- 5,5 mm standart dilim kalınlığı
- %60 daha az yer kaplar
- Special stepped blade design
- Self-lubricating pusher system
- 5.5 mm standard slice thickness
- Takes up 60% less space



Professional

**NEW**

56



Mini

### » Domates Dilimleyici Tomato Slicer

Kod Code	Model Model	Ölçü (cm) Dim (cm)	Ağırlık (kg) Weight (kg)	Koli/Adet Pcs/Ctn
62050007	Professional	22x54x34	10	1
41030025	Mini	16x37x17	3,7	1

\*Domates dilimleyici standart kesim kalınlığı 5 mm'dir  
\*The standard slicing thickness of the tomato slicer is 5 mm

### » Mini Domates Dilimleyici Opsiyonel Bıçak Mini Tomato Slicer Optional Blade

Kod Code	Doğrama Ölçüsü (mm) Cutting Size (mm)	Koli/Adet Pcs/Ctn
41030525	5	1
41030725	7	1
41031025	10	1

### » Professional Domates Dilimleyici Opsiyonel Bıçak Professional Tomato Slicer Optional Blade

Kod Code	Doğrama Ölçüsü (mm) Cutting Size (mm)	Koli/Adet Pcs/Ctn
62050057	5	1
62050077	7	1
62050107	10	1





» Sebze Meyve Doğrayıcı  
Vegetable/Fruit Cutter

**NEW**

Kod Code	Doğrama Ölçüsü (mm) Cutting Size (mm)	Koli/Adet Pcs/Ctn
41030001	12,5x12,5	1

» Limon Dilimleme Makinesi  
Lemon Cutter

**NEW**

Kod Code	Model Model	Koli/Adet Pcs/Ctn
41030009	6 Dilim/6 Pieces	1

» Sebze Meyve Doğrayıcı Bıçak  
Vegetable/Fruit Cutter Blade

Kod Code	Doğrama Ölçüsü (mm) Cutting Size (mm)	Koli/Adet Pcs/Ctn
41032525	25x25	1
41032550	25x50	1

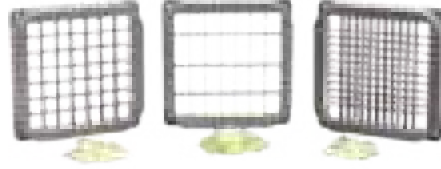

57



77505616

77505629

77505626

» Sebze Meyve Doğrayıcı  
Vegetable/Fruit Wedger

Kod Code	Model Model	Koli/Adet Pcs/Ctn
77505610	Gövde/Body	1
77505616	6 Dilim/6 Pieces	1
77505629	5 mm Dilim-İkiye bölücü/ 5 mm Semi-circle Slice	1
77505626	8x8 mm Dilim/Segment	1





NEW

» Püre Makinesi Paslanmaz Çelik  
S/S Food Mill

Kod Code	Ölçü (cm) Dim. (cm)	Koli/Adet Pcs/Ctn
63010060	37	1

\* Fiyata süzgeçler dahil değildir.  
\* W/o sieve



NEW

» Püre Makinesi Süzgeçleri Paslanmaz Çelik  
Sieve for S/S Food Mill

Kod Code	Delik Ø (mm) Hole Ø (mm)	Koli/Adet Pcs/Ctn
63010061	1	1
63010062	1,5	1
63010063	2	1
63010064	3	1
63010065	4	1



NEW

» Püre Makinesi Paslanmaz Çelik 3 Süzgeçli  
S/S Food Mill w/3 Sieves

Kod Code	Ölçü (cm) Dim (cm)	Koli/Adet Pcs/Ctn
63010059	31	1

\* Süzgeçlerin delik çapları 1,5, 2,5 ve 4 mm'dir.  
\*\* Fiyata süzgeçler dahildir.  
\* Sieves: 1,5, 2,5 and 4 mm  
\*\* w/ Sieves

58



» Püre Makinesi Kalaylı  
Tinned Food Mill

Kod Code	Ölçü (cm) Dim. (cm)	Koli/Adet Pcs/Ctn
62050037	37	1

\* Fiyata süzgeçler dahil değildir.  
\* W/o sieve



» Püre Makinesi Kalaylı Süzgeçleri  
Sieve for Tinned Food Mill

Kod Code	Delik Ø (mm) Hole Ø (mm)	Koli/Adet Pcs/Ctn
62050001	1	1
62050015	1,5	1
62050002	2	1
62050003	3	1
62050004	4	1



» Püre Makinesi Kalaylı 3 Süzgeçli  
Tinned Food Mill w/3 Sieves

Kod Code	Ölçü (cm) Dim (cm)	Koli/Adet Pcs/Ctn
62050031	31	1

\* Süzgeçlerin delik çapları 1,5, 2,5 ve 4 mm'dir.  
\*\* Fiyata süzgeçler dahildir.  
\* Sieves: 1,5, 2,5 and 4 mm  
\*\* w/ Sieves



» Tezgah Tip Konserve Açacağı

Manuel Can Opener

Kod Code	Model Model	Koli/Adet Pcs/Ctn
41130004	Alüminyum Aluminum	1
41230004	Paslanmaz Çelik Stainless Steel	1

» Çekmeceli Ekmek Kesim

Bread Cutting Board w/Drawer

Kod Code	Koli/Adet Pcs/Ctn
49000006	1



» Hamburger Şekillendirici

Hamburger Press

Kod Code	Model Model	Koli/Adet Pcs/Ctn
41040010	Şekillendirici 10 cm Press w/10 cm	1
41040012	Hazne 12 cm Chamber 12 cm	1
41040014	Hazne 14 cm Chamber 14 cm	1

\* 10 cm hazne Şekillendirici fiyatına dahildir.

\*\* Diğer hazneler opsiyoneldir.

\* w/10 cm chamber

\*\* Other chambers are optional

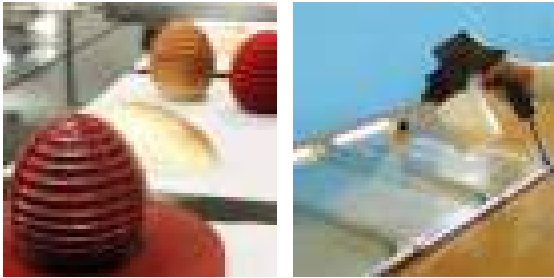

- Yumurta, sıvı yağ, tereyağı, çikolata karışımı, soslar vb.
- 60 Watt güç
- Fırın tepsilerini, kalıpları yağlamakta ve yumurta akı püskürtmekte kolaylık sağlar
- R6 yuvarlak ve F7 düz başlık ile birlikte gelir

• Applying egg, oil, butter, glaze, fondant, chocolate mix, marinades and sauces etc.

• 60 Watts of power

• Greasing baking sheets & tins, and spraying butter etc.

• It comes with R6 round & F7 flat

\* Viskozite / Viscosity: max 80 DIN/sec

\* Ürün aktarım miktarı / Delivery Rate\*: 250g/min (water)



» Gıda Püskürtme Makinası

Food Spray Gun

Kod Code	Kapasite Capacity	Koli/Adet Pcs/Ctn
43031050	0,7 lt	1



» Parizyen Kaşık

Melon Baller

Kod Code	Ø (mm) Ø (mm)	Koli/Adet Pcs/Ctn
83010010	10	6



» Parizyen Kaşık

Melon Baller

Kod Code	Ø (mm) Ø (mm)	Koli/Adet Pcs/Ctn
83010015	15	6



» Parizyen Kaşık

Melon Baller

Kod Code	Ø (mm) Ø (mm)	Koli/Adet Pcs/Ctn
83010022	22	6



» Parizyen Kaşık

Melon Baller

Kod Code	Ø (mm) Ø (mm)	Koli/Adet Pcs/Ctn
83010025	25	6



» Parizyen Kaşık

Melon Baller

Kod Code	Ø (mm) Ø (mm)	Koli/Adet Pcs/Ctn
83010030	30	6



» Oval Parizyen Kaşık

Oval Melon Baller

Kod Code	Koli/Adet Pcs/Ctn
83010005	6

60



» Oval Tırtıklı Parizyen Kaşık

Ribbed Oval Melon Baller

Kod Code	Koli/Adet Pcs/Ctn
83010006	6



» Narenciye Şekillendirici (Tek Delik)

Lemon Striper w/One Hole

Kod Code	Koli/Adet Pcs/Ctn
83010031	6



» Kabuk Şekillendirici

Decorator

Kod Code	Koli/Adet Pcs/Ctn
40010042	6



» "V" Dekoratör

"V" Shaped Decorator

Kod Code	Koli/Adet Pcs/Ctn
83010009	6



» Üçgen Dekoratör

Triangular Decorator

Kod Code	Koli/Adet Pcs/Ctn
83010008	6



» Elma Oyacağı

Apple Corer

Kod Code	Koli/Adet Pcs/Ctn
40010043	6



» Dişli Rulet İkili  
Double Pastry Wheel

Kod Code	Koli/Adet Pcs/Ctn
83010017	6



» Pizza Ruleti  
Pizza Roulette

Kod Code	Ölçü (cm) Dim. (cm)	Koli/Adet Pcs/Ctn
62010021	10	6



» Y-Soyacak  
Y-Peeler

Kod Code	Koli/Adet Pcs/Ctn
40010130	6



» Sebze Soyacağı  
Vegetable Peeler

Kod Code	Koli/Adet Pcs/Ctn
40010029	6



» Soyacak Hareketli  
Swivel Peeler

Kod Code	Koli/Adet Pcs/Ctn
47001023	6



» Y-Soyacak  
Y-Peeler

Kod Code	Koli/Adet Pcs/Ctn
40100100	6



» Tereyağ Çekici  
Butter Curler

Kod Code	Koli/Adet Pcs/Ctn
40010030	6



» Yumuşak Peynir Bıçağı  
Cheese Knife

Kod Code	Koli/Adet Pcs/Ctn
40010032	6



» Peynir Dilimleyici  
Cheese Slicer

Kod Code	Koli/Adet Pcs/Ctn
40010031	6



» Tavuk Makası  
Poultry Shears

Kod Code	Koli/Adet Pcs/Ctn
40010057	4



» Çok Amaçlı Mutfak Makası  
Multi-Purpose Kitchen Scissors

Kod Code	Koli/Adet Pcs/Ctn
83010002	4



» Konserve Açacağı  
Can Opener

Kod Code	Koli/Adet Pcs/Ctn
40010044	6



» Dekoratör  
Decorator (S/S)

Kod Code	Koli/Adet Pcs/Ctn
62050013	2



» Ceviz Kıracağı  
Nut Cracker (S/S)

Kod Code	Koli/Adet Pcs/Ctn
62040006	4



» Sarımsak Ezici  
Garlic Press (S/S)

Kod Code	Koli/Adet Pcs/Ctn
62040007	2

62



» Hassas Terazi  
Digital Scale

Kod Code	Kapasite Capacity	Hassasiyet Accuracy	Ölçü (cm) Dim. (cm)	Koli/Adet Pcs/Ctn
65010010	10 Kg	1 g	14,5x14,5	3



» Hassas Terazi  
Digital Scale

Kod Code	Kapasite Capacity	Hassasiyet Accuracy	Ölçü (cm) Dim. (cm)	Koli/Adet Pcs/Ctn
65010025	25 Kg	1 g	17,5x20	3



» Baskül  
Receiving Digital Scale

Kod Code	Kapasite Capacity	Ölçü (cm) Dim. (cm)	Koli/Adet Pcs/Ctn
65010150	150 Kg	40x50	1
65010300	300 Kg	60x70	1



» Hassas Terazi  
Digital Scale

Kod Code	Kapasite Capacity	Hassasiyet Accuracy	Ölçü (cm) Dim. (cm)	Koli/Adet Pcs/Ctn
65010003	3 Kg	0,5-1 g	17,6x22,3	1



» Şef Cımbızı  
Chef's Tong

Kod Code	Ölçü (mm) Dim. (mm)	Model Model	Koli/Adet Pcs/Ctn
77502913	145x10	Düz/Straight	6
77502021	180x25	Belli/Angular	6
77500025	250	Düz/Straight	6
77504030	170x25	Kaşıklı/w Tasting Spoon	6

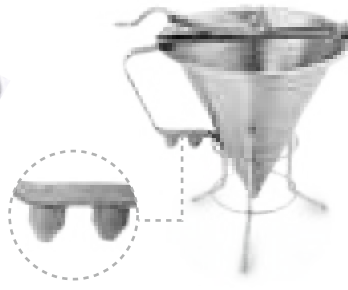

» Sos Hunisi  
Sauce Gun

Kod Code	Koli/Adet Pcs/Ctn
62010019	1

\* İki farklı kalınlıkta akıtma ağzı seçeneği.  
\* Includes two interchangeable tips.



» Yumurta Çemberi  
Egg Ring

Kod Code	Ölçü (cm) Dim. (cm)	Model Model	Koli/Adet Pcs/Ctn
62010039	Ø 10	Yuvarlak/Round	10
62010029	10x10	Kare / Square	10



» Sipariş Tutucu (Bilyeli)  
Tickets-holder

Kod Code	Ölçü (cm) Dim. (cm)	Koli/Adet Pcs/Ctn
62010061	61	6
62010075	75	6
62010100	100	6



» Karıştırıcı Palet (Paslanmaz)  
Mixing Spatula (S/S)

Kod Code	Ölçü (cm) Dim. (cm)	Koli/Adet Pcs/Ctn
62010142	107	1



» Patates Ezici (Paslanmaz)  
Potato Masher (S/S)

Kod Code	Ölçü (cm) Dim. (cm)	Koli/Adet Pcs/Ctn
62010128	71	1



» Şaşula (Paslanmaz)  
Scoop (S/S)

Kod Code	Kapasite (gr) Capacity (gr)	Koli/Adet Pcs/Ctn
44014301	100	6
44014302	135	6
44014303	250	6
44014304	380	6
44014305	560	6



» Düz Şaşula (Polikarbonat)  
PC Scoop

Kod Code	Model Model	Koli/Adet Pcs/Ctn
46010116	Düz/Plain	24
46010117	Delikli/Perforated	24



» Patası (Polietilen)  
Spatula (Polyethylene)

Kod Code	Ölçü (cm) Dim. (cm)	Koli/Adet Pcs/Ctn
49000030	30	1
49000035	35	1
49000045	45	1
49000055	55	1
49000065	65	1
49000075	75	1
49000100	100	1
49000120	120	1

## Rendeler / Graters



**NEW**

» El Rendesini İnce  
Hand Grater Rasp

Kod Code	Koli/Adet Pcs/Ctn
83100042	6



**NEW**

» El Rendesini Ekstra Kalın  
Hand Grater Extra Coarse

Kod Code	Koli/Adet Pcs/Ctn
83100041	6



**NEW**

» El Rendesini Shaver  
Hand Grater Shaver

Kod Code	Koli/Adet Pcs/Ctn
83100044	6



**NEW**

» El Rendesini Ribbon  
Hand Grater Ribbon

Kod Code	Koli/Adet Pcs/Ctn
83100043	6



**NEW**

» Rende Shaver  
Grater Shaver

Kod Code	Koli/Adet Pcs/Ctn
83100020	6



**NEW**

» Rende Ekstra Kalın  
Grater Extra Coarse

Kod Code	Koli/Adet Pcs/Ctn
83100040	6



**NEW**

» Rende Ribbon  
Grater Ribbon

Kod Code	Koli/Adet Pcs/Ctn
83100010	6

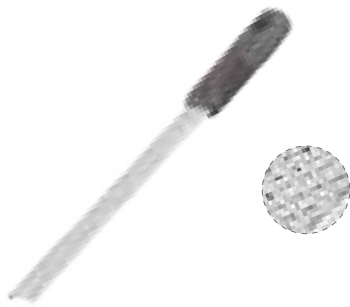

» İnce El Rendesini  
Rasp Grater

Kod Code	Koli/Adet Pcs/Ctn
83100050	6



» Piramit Rende  
Grater

Kod Code	Koli/Adet Pcs/Ctn
44013300	6



» Endüstriyel Rende  
Industrial Grater

Kod Code	Koli/Adet Pcs/Ctn
44013301	6



» Ölçülü Mayonez Kabı  
Calibrated Mixing Bowl

Kod Code	Øxh (cm) Øxh (cm)	Koli/Adet Pcs/Ctn
35050016	16x8	4
35050020	20x10	4
35050024	24x12	4
35050030	30x15	2
35050036	36x18	2



» Konik Ölçülü Kap  
Calibrated Conical Bowl

Kod Code	Øxh (cm) Øxh (cm)	Koli/Adet Pcs/Ctn
62015020	20	6
62015024	24	6
62015028	28	6
62015032	32	4
62015036	36	4
62015040	40	1
62015045	45	1



» Çelik Kova  
Calibrated Bucket (S/S)

Kod Code	Lt Lt	Koli/Adet Pcs/Ctn
52020012	12	1



» Ölçülü Maşrapa  
Calibrated Bain-Marie Pot

Kod Code	Øxh (cm) Øxh (cm)	Koli/Adet Pcs/Ctn
35701416	14x16	2
35701618	16x18	2
35701820	18x20	2
35702022	20x22	2



» Polikarbonat Ölçme Kabı  
PC Measuring Cup

Kod Code	Lt Lt	Koli/Adet Pcs/Ctn
60021001	1	6
60021002	2	6
60021003	3	4



» Polipropilen Ölçme Kabı  
PP Measuring Cup

Kod Code	Lt Lt	Koli/Adet Pcs/Ctn
43031001	0,5	6
43031002	1	6
43031003	2	6
43031004	3	6
43031006	5	6



» Ölçü Kabı  
Measuring Cup

Kod Code	Lt Lt	Koli/Adet Pcs/Ctn
62010001	1	6
62010002	2	6



» Dörtlü Ölçek Seti  
Measuring Cup Set

Kod Code	Koli/Adet Pcs/Ctn
40010058	6
*1/4 - 1/3 - 1/2 - 1/1 Cup	



» Dörtlü Ölçü Kaşık Seti  
Measuring Spoon Set

Kod Code	Koli/Adet Pcs/Ctn
40010059	6
*2,5 cc - 5 cc - 7,5 cc - 15 cc	

## Termometreler / Thermometers

- -50 +200°C / -58 +392°F
- Suya dayanıklı/Waterproof
- S/S Delici Çubuk/Probe :125 mm



» Dijital Çok Amaçlı Cep Termometresi  
Multi-Purpose Digital Pocket Thermometer

Kod Code	Koli/Adet Pcs/Ctn
43030121	6

- -50 +200°C / -58 +392°F
- Suya dayanıklı/Waterproof
- S/S Delici Çubuk/Probe :125 mm



» Dijital Cep Termometresi  
Digital Pocket Thermometer

Kod Code	Koli/Adet Pcs/Ctn
62060004	6

- 0+300°C / 32+600 °F
- S/S Delici Çubuk/S/S Probe :150 mm
- Ø : 50 mm



» Pişirme/Kızartma Termometresi  
Cooking & Frying Thermometer

Kod Code	Koli/Adet Pcs/Ctn
62060001	2

- +50 +300 °C / +100 +600 °F
- Paslanmaz çelik gövde/S/S Body
- Ø : 83 mm
- Mikrodalga fırınlarda kullanılmaz/  
Do not use in microwave oven



» Fırın Termometresi  
Dial Oven Thermometer

Kod Code	Koli/Adet Pcs/Ctn
62060008	2



- +54 +88 °C / +130 +190 °F
- S/S Delici Çubuk/S/S Probe :145 mm
- Ø : 50 mm



» Et Termometresi  
Meat Thermometer

Kod Code	Koli/Adet Pcs/Ctn
62060006	2

66

- -50 +70 °C / -58 +158 °F / 20-99% RH
- Kablo : 2 m/Cable : 2 m
- Çift Ekran / Double Display
- Donma noktası alarmı / Ice point alert  
: Max/Min - In/Out



» Dijital Termometre Ve Nem Ölçer  
Digital Thermometer And Moisture Meter

Kod Code	Koli/Adet Pcs/Ctn
62060013	1

- -50 +70 °C / -58 +158 °F
- Kablo : 1 m/Cable : 1 m
- Miknats/Magnetic back
- Max-mini. programlanabilir alarm  
Maxi-mini - Programmable alarm only
- Alarm kapatılana kadar çalar  
Stops ringing only if it is turned off



» Dijital Buzdolabı Termometresi  
Digital Fridge Thermometer

Kod Code	Koli/Adet Pcs/Ctn
62060002	2

- 19 saat - 59 dakika zamanlayıcı  
Timer 19 h - 59 m
- 19 saat - 59 dakika kronometre  
Stopwatch 19 h - 59 m
- Alarm
- Miknatslı ve Standlı / Magnetic back  
/ Free Standing



» Dijital Zamanlayıcı Saat  
Digital Timer

Kod Code	Koli/Adet Pcs/Ctn
62060009	2

- -30 +30 °C / -20 +80 °F
- Paslanmaz çelik gövde/S/S Body
- Ø : 50 mm
- Fırın ve Mikrodalga fırınlarda kullanılmaz  
*Do not use in oven and microwave oven*



» Buzdolabı Termometresi  
Fridge/Freezer Thermometer

Kod Code	Koli/Adet Pcs/Ctn
62060007	2

- Reçel, jöle, likör, şerbet yapımı için / For making Jam, jelly, liqueur, sorbet
- Çift ölçek/Double Scale : 1100-1400 g/m-15-40°Bé
- Kalibrasyon Derecesi / Calibration temp : 20°C
- Kurşun içermez / Lead free



» Şurup Hidrometresi  
Syrup Hydrometer

Kod Code	Koli/Adet Pcs/Ctn
62060011	1

- Negatif Ölçek / Negative Scale : 1020-1040 g/ml
- Div : 0.0005 g/ml
- Sap Termometresi / Thermometer in the stem : 0+40°C : 1°C, Kırmızı sıvı/ Red liquid, ±310mm



» Süt Termometresi  
Milk Thermometer

Kod Code	Koli/Adet Pcs/Ctn
62060012	1

- Pişirme anında ısı kontrolü
- Kremalar, karamelize soslar ve çikolata için ideal
- 220 °C'ye kadar dayanıklı sap
- Çıkarılabilir termometre
- Termometre -20° + 200°C
- 385 mm uzunluk
- Su geçirmez
- Bulaşık makinasında yıkanmaya uygun değildir
- Control the temperature of your dish during cooking, while mixing at the same time
- Ideal for creams, caramelized sugar, chocolate
- Handle resists up to 220°C, dishwasher safe
- Removable thermometer -20° to +200°C, precision 0.1°C, reliability to 1°C
- 385 mm length
- Tight against water splashing, not suitable for dishwasher



**NEW**

» Spatula Termometre  
Spatula Thermometer

Kod Code	Koli/Adet Pcs/Ctn
77503090	1

- -50 + 530°C / -58 + 986°F
- Uzaklık değeri/Distance Ratio : 12/1
- LCD Ekran / LCD Screen



» Kızılötesi Termometre (Lazer Göstergeli)  
Infrared Thermometer

Kod Code	Koli/Adet Pcs/Ctn
62060005	1

- +80 +200°C
- Kademeli daldırma 70 mm
- Civasız kırmızı gösterge
- +/- 350 mm uzunluk
- Paslanmaz çelik koruma kabı
- Fırın ve Mikrodalga fırınlarda kullanılmaz
- +80 +200°C
- Partial immersion 70 mm
- In glass-red liquid filled
- +/- 350 mm length
- w/Stainless Steel protection sleeve
- Not suitable for ovens and microwaves

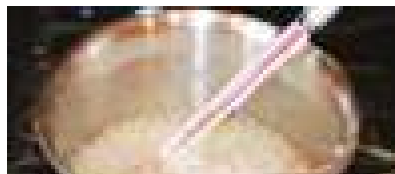

» Şeker Termometresi  
Sugar Thermometer

Kod Code	Koli/Adet Pcs/Ctn
62060003	2



» Havan (Polietilen)

Mortar (Polyethylene)

Kod Code	Model Model	Koli/Adet Pcs/Ctn
49020002	Küçük/Small	1
49020004	Büyük/Big	1



» Bal Tokmağı (Polietilen)

Honey Spoon (Polyethylene)

Kod Code	Koli/Adet Pcs/Ctn
49020010	1



» Balık Pulu Temizleyicisi (Polietilen)

Fish Scale Cleaner (Polyethylene)

Kod Code	Koli/Adet Pcs/Ctn
49020020	1



» Un Elek (Paslanmaz)

Sieve (S/S)

Kod Code	Ø (cm) Ø (cm)	Koli/Adet Pcs/Ctn
44013025	25	2
44013030	30	2
44013040	40	2



» Kalbur (Paslanmaz)

Grate (S/S)

Kod Code	Ø (cm) Ø (cm)	Koli/Adet Pcs/Ctn
44013125	25	2
44013130	30	2
44013140	40	2



» Un Elek (S/S)

Flour Sifter (S/S)

Kod Code	Koli/Adet Pcs/Ctn
43133000	2

68



» Helvane Süzgeç

Colander

Kod Code	Ø (cm) Ø (cm)	Koli/Adet Pcs/Ctn
30423609	36x9	3
30423812	38x12	3
30424512	45x12	3
30425012	50x12	2
30426012	60x14	2
30427014	70x14	2
30428016	80x16	1



» Süzgeç Kaçarola

Colander for Sauce Pan

Kod Code	Ø (cm) Ø (cm)	Koli/Adet Pcs/Ctn
31380005	20x13	2
31380006	24x15	2
31380020	28x17	2



» Çelik Süzgeç

Colander

Kod Code	Ø (cm) Ø (cm)	Koli/Adet Pcs/Ctn
62010028	28	4
62010032	32	4
62010036	36	2
62010040	40	2



» Exoglass Konik Sık Süzgeç

Exoglass Bouillon Strainer

Kod Code	Ø (cm) Ø (cm)	Koli/Adet Pcs/Ctn
77507360	20x22	1



» Çin Külahlı

Chinese Colander

Kod Code	Ø (cm) Ø (cm)	Koli/Adet Pcs/Ctn
62010016	16	4
62010020	20	4
62010024	24	2



» Konik Sos Süzgeci Destekli

S/S Bouillon Strainer

Kod Code	Ø (cm) Ø (cm)	Koli/Adet Pcs/Ctn
62011290	22x23	1



» Konik Süzgeç

Conical Strainer

Kod Code	Ø (cm) Ø (cm)	Koli/Adet Pcs/Ctn
62013016	16	6
62014020	20	6



» Baharat Shaker

Shaker

Kod Code	Ölçü (cm) Dim. (cm)	Model Model	Koli/Adet Pcs/Ctn
62021789	7	Büyük Delikli Big Hole	6
62023789	7	Küçük Delikli Small Hole	6
62022789	7	Süzgeç Mesh	6



» Makarna Pişirme Süzgeci

1/4-Segment Pasta Colander

Kod Code	Ölçü (cm) Dim. (cm)	Koli/Adet Pcs/Ctn
36302420	24x19,5 Tencere ile uyumlu Suitable for 24x19,5 Pot	3
36303623	36x22 Tencere ile uyumlu Suitable for 36x22 Pot	4
36304026	40x25 Tencere ile uyumlu Suitable for 40x25 Pot	4



» Mermer Havan

Marble Mortar

Kod Code	Model Model	Koli/Adet Pcs/Ctn
78021005	10x5,5	1
78021011	10x11	1





» Huni (Süzgeçli)

Funnel w/Strainer

Kod Code	Ölçü (cm) Dim. (cm)	Koli/Adet Pcs/Ctn
62010475	12	4



» Derin Kepçe Sık (Paslanmaz)

Round Strainer (S/S)

Kod Code	Ölçü (cm) Dim. (cm)	Koli/Adet Pcs/Ctn
44013424	24	6
44013427	27	6
44013430	30	6



» Derin Kepçe Seyrek (Paslanmaz)

Coarse Round Strainer (S/S)

Kod Code	Ölçü (cm) Dim. (cm)	Koli/Adet Pcs/Ctn
44013324	24	6
44013327	27	6
44013330	30	6

70



» Tel Süzgeç (Paslanmaz)

Round Strainer (S/S)

Kod Code	Ölçü (cm) Dim. (cm)	Koli/Adet Pcs/Ctn
62010018	18	6
62010022	22	6
62010026	26	6



» Tel Kevgir Sık (Paslanmaz)

Mesh Skimmer (S/S)

Kod Code	Ölçü (cm) Dim. (cm)	Koli/Adet Pcs/Ctn
44013217	17	6
44013222	22	6
44013227	27	6
44013230	30	6



» Tel Kevgir Seyrek (Paslanmaz)

Coarse Mesh Skimmer (S/S)

Kod Code	Ölçü (cm) Dim. (cm)	Koli/Adet Pcs/Ctn
44013817	17	6
44013822	22	6
44013827	27	6
44013830	30	6



» Tencere Teli (Paslanmaz)

Strainer for Pot (S/S)

Kod Code	Ölçü (cm) Dim. (cm)	Koli/Adet Pcs/Ctn
44013015	30x15	2
44014020	40x20	2
44015020	50x20	2
44016020	60x20	2
44017030	70x30	1
44018030	80x30	1



» Tava Teli (Paslanmaz)

Strainer for Pan (S/S)

Kod Code	Ölçü (cm) Dim. (cm)	Koli/Adet Pcs/Ctn
44014011	40x11	2
44015012	50x12	2
44016014	60x14	2
44017015	70x15	1
44018016	80x16	1





» Askılı Çırpıcı (Paslanmaz)

Wire Whip (S/S)

Kod Code	Ölçü (cm) Dim. (cm)	Koli/Adet Pcs/Ctn
40010061	25	6
40010062	30	6
40010063	35	6
40010064	40	4
40010065	45	4
40010066	50	4
40010067	55	2
40010068	60	2



» Çırpma Teli (Krom)

Balloon Whisk (Chrome Plated)

Kod Code	Ölçü (cm) Dim. (cm)	Koli/Adet Pcs/Ctn
44010274	74	1
44010298	98	1
44012120	120	1



» Çırpıcı

Whisk

Kod Code	Ölçü (cm) Dim. (cm)	Koli/Adet Pcs/Ctn
62021890	26	6
62020031	31	6
62020036	36	6
62020041	41	4
62020046	46	2
62020051	51	2

\* Çırpıcı sapı mavi/siyah olabilir  
\* Handles might be blue/black



» Yumurta Çırpıcı

Egg Whisk

Kod Code	Ölçü (cm) Dim. (cm)	Koli/Adet Pcs/Ctn
40010071	10	6
40010072	20	6



» Piyano Çırpıcı (Paslanmaz)

Whisk (S/S)

Kod Code	Ölçü (cm) Dim. (cm)	Koli/Adet Pcs/Ctn
40010069	25	6
40010070	35	6



» Piyano Çırpıcı (P/P)

Piano Whisk (P/P)

Kod Code	Ölçü (cm) Dim. (cm)	Koli/Adet Pcs/Ctn
40100101	25	6
40100102	30	6
40100103	35	6
40100104	40	6



» Silikon Fırça

Silicone Brush

Kod Code	Ölçü (cm) Dim. (cm)	Koli/Adet Pcs/Ctn
52030006	21x3,5	6



» Fırça (Sentetik)

Brush

Kod Code	No No	Ölçü (cm) Dim. (cm)	Koli/Adet Pcs/Ctn
43600002	2	22x4	6
43600003	3	22,5x6,5	6

## Spatulalar / Spatulas

Max. + 180°C



### » Silikon Spatula Silicone Spatula

Kod Code	Ölçü (cm) Dim. (cm)	Koli/Adet Pcs/Ctn
52030555	27	6
52030777	38	6
52030007	43	6

Max. + 220°C



### » Isıya Dayanıklı Spatula Heat-Resistant Spatula

Kod Code	Ölçü (cm) Dim. (cm)	Koli/Adet Pcs/Ctn
77503025	25	6
77503030	30	6
77503035	35	4
77503040	40	4
77503045	45	2



NEW

### » Silikon Kaşık Spatula Silicone Spoon Spatula

Kod Code	Ölçü (cm) Dim. (cm)	Koli/Adet Pcs/Ctn
62022500	27	4
62023500	38	4
62024500	43	4

72



### » Pasta Spatula Pastry Spatula

Kod Code	Ölçü (cm) Dim. (cm)	Koli/Adet Pcs/Ctn
62013025	25	4
62013030	30	4
62013035	35	2



### » Belli Pasta Spatula Angular Spatula

Kod Code	Ölçü (cm) Dim. (cm)	Koli/Adet Pcs/Ctn
62010025	25	4



### » Spatula Spatula

Kod Code	Ölçü (cm) Dim. (cm)	Koli/Adet Pcs/Ctn
62010010	10	4
62010013	13	4
62010015	15	4



### » Geniş Spatula Wide Spatula

Kod Code	Ölçü (cm) Dim. (cm)	Koli/Adet Pcs/Ctn
62012020	20	4
62011025	25	4



### » Geniş Spatula Delikli Perforated Wide Spatula

Kod Code	Ölçü (cm) Dim. (cm)	Koli/Adet Pcs/Ctn
62012025	25	4



### » Pizza Küreği Pizza Spatula

Kod Code	Ölçü (cm) Dim. (cm)	Model Model	Koli/Adet Pcs/Ctn
62010008	17	Normal Plain	4
62010014	17	Delikli Perforated	4



» Servis Spatula (Paslanmaz)

Serving Spatula (S/S)

Kod Code	Ölçü (cm) Dim. (cm)	Koli/Adet Pcs/Ctn
62010011	25	6



**NEW**

» Pizza Turner

Pizza Turner

Kod Code	Ölçü (cm) Dim. (cm)	Koli/Adet Pcs/Ctn
83100047	25,5	2
83100048	30,5	2



**NEW**

» Pancake Turner

Pancake Turner

Kod Code	Ölçü (cm) Dim. (cm)	Koli/Adet Pcs/Ctn
83100046	16,5x19	2



**NEW**

» Pişirme Çatalı

Carving Fork

Kod Code	Ölçü (cm) Dim. (cm)	Koli/Adet Pcs/Ctn
83100045	20	2

73



» Pizza Ruleti

Pizza Roulette

Kod Code	Ölçü (cm) Dim. (cm)	Koli/Adet Pcs/Ctn
62010021	10	6

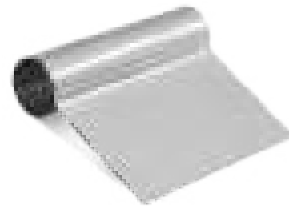

» Hamur Kazıyıcısı (Paslanmaz Saplı)

Dough Scraper (S/S Handle)

Kod Code	Ölçü (cm) Dim. (cm)	Koli/Adet Pcs/Ctn
62010006	13x11	6



490 491 492 493 494 495



» Polietilen Kesim Levhaları

Cutting Boards

Kod Code	Ölçü (cm) Dim. (cm)	Koli/Adet Pcs/Ctn
49050404	25x40x4	1
49030404	30x40x4	1
49030504	30x50x4	1
49030604	40x60x4	1
49025402	25x40x2	1
49030402	30x40x2	1
49030502	30x50x2	1
49063202	32,5x26,5x2	1
49025302	32,5x53x2	1
49060402	60x40x2	1



» Kesim Levhası (GN 1/1 Küvet ile uyumlu)

Cutting Board for GN Pan

Kod Code	Model Model	Koli/Adet Pcs/Ctn
49020030	GN 1/1-100 Küvet için Cutting Board for GN 1/1 Pan	1

\* GN küvet fiyata dahil değildir.

\* w/o G/N Pan.

74



» Kesim Levhası İstif Teli (6 Bölmeli)

Cutting Board Rack S/S (6 Partitioned)

Kod Code	Ölçü (cm) Dim. (cm)	Koli/Adet Pcs/Ctn
62021885	30,5x26,5x26,5	1

\* 2 cm kalınlığındaki levhalara uygundur.

\* Suitable for 2mm cutting board

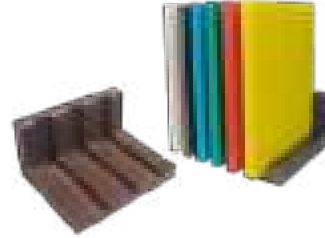

» Polietilen İstif Rafı

Storing Shelf for Cutting Board

Kod Code	Kalınlık (cm) Thickness (cm)	Koli/Adet Pcs/Ctn
49000002	2	1
49000004	4	1



» Polietilen Levha Temizleme Bıçağı

Board Scraper (Polyethylene)

Kod Code	Koli/Adet Pcs/Ctn
49000003	1







» Şef Bıçağı  
 Chef's Knife

Kod Code	Ölçü (cm) Dim. (cm)
60521600	16
60522000	20
60522300	23
60522600	26
60523100	31



» Kasap Bıçağı  
 Butcher Knife

Kod Code	Ölçü (cm) Dim. (cm)
60521800	18
60522100	21
60522400	24
60522700	27
60523000	30



» Et Bıçağı Tırtıklı  
 Steak knife Serrated Edge

Kod Code	Ölçü (cm) Dim. (cm)
63528750	12

76



» Dişli Ekmek Bıçağı  
 Bread Knife Wavy Edge

Kod Code	Ölçü (cm) Dim. (cm)
60521210	21



» Dişli Belli Ekmek Bıçağı  
 Bread Knife Wavy Edge Angular

Kod Code	Ölçü (cm) Dim. (cm)
60521230	23



» Çok Amaçlı Bıçak  
 Multi Purpose Knife

Kod Code	Ölçü (cm) Dim. (cm)
60522130	13
60522160	16
60522180	18
60522210	21



» Kemik Sıyırma Bıçağı  
 Boning Knife

Kod Code	Ölçü (cm) Dim. (cm)
60521400	14
60521610	16



» Manyatıslı Bıçaklık  
 Magnetic Board

Kod Code	Ölçü (cm) Dim. (cm)	Koli/Adet Pcs/Ctn
45081205	50	6
60500002	64	1

\* Bıçaklar tekli satılmaktadır \* Knives are sold individually



» Soyma Bıçağı  
Paring Knife

Kod Code	Ölçü (cm) Dim. (cm)
63528315	8



» Et Bıçağı  
Steak Knife

Kod Code	Ölçü (cm) Dim. (cm)
63528242	12



**NEW**

» Et Çatalı  
Steak fork

Kod Code	Ölçü (cm) Dim. (cm)
63529450	12



» Kasap Bıçağı  
Breaking Knife

Kod Code	Ölçü (cm) Dim. (cm)
63523240	18



» Fileto Bıçağı  
Filleting Knife

Kod Code	Ölçü (cm) Dim. (cm)
63527365	18



» Deri Yüzme Bıçağı  
Descaling Knife

Kod Code	Ölçü (cm) Dim. (cm)
63528315	15



» Parçalama Bıçağı  
Breaking Knife

Kod Code	Ölçü (cm) Dim. (cm)
63523220	25



» Yüzme Bıçağı  
Skinning Knife

Kod Code	Ölçü (cm) Dim. (cm)
63523221	13



» Sıyırma Bıçağı  
Boning Knife

Kod Code	Ölçü (cm) Dim. (cm)
63523225	13





78



» Sebze Bıçağı

Paring Knife

Kod Code	Ölçü (cm) Dim. (cm)	Koli/Adet Pcs/Ctn
45091041	9	6
45091042	12	6
45091043	14,5	6

» Şef Bıçağı

Cook's Knife

Kod Code	Ölçü (cm) Dim. (cm)	Koli/Adet Pcs/Ctn
45091160	19	6
45091161	21	6
45091162	23	6

» Parmak Koruyucu S/S Yüzük

Finger Guard S/S Ring

Kod Code	Ölçü (cm) Dim (cm)	Koli/Adet Pcs/Ctn
93000006	7x4	1





» Steak Bıçağı  
Steak Knife

Kod Code	Ölçü (cm) Dim. (cm)	Koli/Adet Pcs/Ctn
45391011	16	6



» Peynir Bıçağı  
Cheese Knife

Kod Code	Ölçü (cm) Dim. (cm)	Koli/Adet Pcs/Ctn
45691070	13,5	6
45691071	15,5	6
45691072	17,5	6



» Doğrama Bıçağı  
Chopping Knife

Kod Code	Ölçü (cm) Dim. (cm)	Koli/Adet Pcs/Ctn
45000001	14	6
45000002	16	6
45000003	18	6
45000004	20	6



» Kruvasan Bıçağı  
Croissant Knife

Kod Code	Ölçü (cm) Dim. (cm)	Koli/Adet Pcs/Ctn
41030023	23	6
41030024	35	6



» Ekmek Bıçağı  
Bread Knife

Kod Code	Ölçü (cm) Dim. (cm)	Koli/Adet Pcs/Ctn
45091052	15,5	6
45091053	17,5	6



» Dişli Ekmek Bıçağı  
Bread Knife

Kod Code	Ölçü (cm) Dim. (cm)	Koli/Adet Pcs/Ctn
45340923	15,5	6
45350923	18	6
45041023	21	6



» Baklava Bıçağı  
Pastry Knife

Kod Code	Ölçü (cm) Dim. (cm)	Koli/Adet Pcs/Ctn
45091171	16	6



» Kaymak Bıçağı  
Heavy Cream Knife

Kod Code	Ölçü (cm) Dim. (cm)	Koli/Adet Pcs/Ctn
45091172	19	6



» Börek Bıçağı  
Pastry & Pie Knife

Kod Code	Ölçü (cm) Dim. (cm)	Koli/Adet Pcs/Ctn
45071080	16,5	6
45071081	18	6
45071082	20	6

\* Ölçüler sap hariçtir \*Dimensions do not include handles



» Kaşar Bıçağı

Ham Knife

Kod Code	Ölçü (cm) Dim. (cm)	Koli/Adet Pcs/Ctn
4500005	35	1



» Kaşar Bıçağı (Çift Saplı)

Ham Knife (Double Handled)

Kod Code	Ölçü (cm) Dim. (cm)	Koli/Adet Pcs/Ctn
4500006	30	1

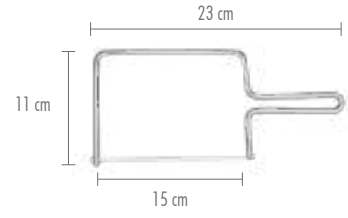

» Peynir Kesici

Cheese Slicer

Kod Code	Ölçü (cm) Dim. (cm)	Koli/Adet Pcs/Ctn
62050017	15	4

\* Yedek tel ürüne dahildir

\* Replacement wire included



» Döner Bıçağı

Doner Kebab Knife

Kod Code	Ölçü (cm) Dim. (cm)	Koli/Adet Pcs/Ctn
45071004	55	6



» Jambon Bıçağı

Ham Knife

Kod Code	Ölçü (cm) Dim. (cm)	Koli/Adet Pcs/Ctn
4500007	30	6



» Kasap Bıçağı

Butcher Knife

Kod Code	Ölçü (cm) Dim. (cm)	Koli/Adet Pcs/Ctn
45091000	12,5	6
45091001	14,5	6
45091002	16,5	6
45091003	19	6
45091004	21	6



» Et Açma Bıçağı

Filleting Knife

Kod Code	Ölçü (cm) Dim. (cm)	Koli/Adet Pcs/Ctn
45000030	30	1
45000035	35	1



» Kemik Sıyırma Bıçağı

Boning Knife

Kod Code	Ölçü (cm) Dim. (cm)	Koli/Adet Pcs/Ctn
45091014	14	6
45091016	16	6



» Kemik Sıyırma Bıçağı Hilal

Boning Knife Crescent

Kod Code	Ölçü (cm) Dim. (cm)	Koli/Adet Pcs/Ctn
45091013	13	6
45091015	15	6

\* Ölçüler sap hariçtir

\* Dimensions do not include handles





» Kavisli Yüzme Bıçağı  
Curved Skinner Knife

Kod Code	Ölçü (cm) Dim. (cm)	Koli/Adet Pcs/Ctn
45070923	14	6
45070925	15	6



» Trimleme Bıçağı  
Trim Knife

Kod Code	Ölçü (cm) Dim. (cm)	Koli/Adet Pcs/Ctn
45471025	21	6
45571025	25	6



» Lakerda Bıçağı  
Fish Filleting Knife

Kod Code	Ölçü (cm) Dim. (cm)	Koli/Adet Pcs/Ctn
45291092	21	6
45291091	25	6



» Balıkçı Bıçağı  
Fisher Knife

Kod Code	Ölçü (cm) Dim. (cm)	Koli/Adet Pcs/Ctn
45091151	35	2



» Satır  
Cleaver

Kod Code	Ölçü (cm) Dim. (cm)	Koli/Adet Pcs/Ctn
45061111	20	1
45061112	23	1



» Tavuk Satırı  
Poultry Cleaver

Kod Code	Ölçü (cm) Dim. (cm)	Koli/Adet Pcs/Ctn
45000008	19	1



» Et Döveceği (Polietilen)  
Meat Tenderiser (Polyethylene)

Kod Code	Ölçü (cm) Dim. (cm)	Koli/Adet Pcs/Ctn
49000005	40	4



» Et Döveceği (Alüminyum)  
Meat Tenderiser (Aluminum)

Kod Code	Koli/Adet Pcs/Ctn
62010017	4



» Et Döveceği  
Meat Tenderiser

Kod Code	Koli/Adet Pcs/Ctn
45000036	4



» Soğan Satırı  
Onion Knife

Kod Code	Ölçü (cm) Dim. (cm)	Koli/Adet Pcs/Ctn
45061060	19	1



» Paslanmaz Zırh  
Mincing Knife (S/S)

Kod Code	Ölçü (cm) Dim. (cm)	Koli/Adet Pcs/Ctn
45000018	30	1
45000019	35	1
45000020	40	1
45000021	45	1
45000022	50	1
45000023	55	1



» Çift Saplı Zırh  
Mincing Knife w/Double Handles

Kod Code	Ölçü (cm) Dim. (cm)	Koli/Adet Pcs/Ctn
45000024	25	1
45000025	30	1

\* Ölçüler sap hariçtir  
\* Dimensions do not include handles



» Pizza Bıçağı  
Pizza Knife

Kod Code	Ölçü (cm) Dim. (cm)	Koli/Adet Pcs/Ctn
45071120	26	1



» Dekor Seti  
Decoratıon Knife Set

Kod Code	Koli/Adet Pcs/Ctn
45041330	1



» Yuvarlak Masat  
Sharpening Steel (Round)

Kod Code	Ölçü (cm) Dim. (cm)	Koli/Adet Pcs/Ctn
45081083	12	6



» Yassı Masat  
Sharpening Steel

Kod Code	Ölçü (cm) Dim. (cm)	Koli/Adet Pcs/Ctn
45081088	12	6



» Adana Şiş  
Skewer (S/S)

Kod Code	Ölçü (cm) Dim. (cm)	Model Model	Koli/Adet Pcs/Ctn
45081152	60	S/S	12
45081153	60	Galvaniz/Galvanized	



» Et Çengeli  
Meat Hook

Kod Code	Ölçü (cm) Dim. (cm)	Koli/Adet Pcs/Ctn
62020010	10	12
62020015	15	12
62020025	25	12



» Et Çengeli  
Meat Hook

Kod Code	Ölçü (cm) Dim. (cm)	Model Model	Koli/Adet Pcs/Ctn
45081040	8	Nikel Nickel	12
45081056	8	Krom Chrome	12



» Çelik Örgü Eldiven  
S/S Chainmail Butcher Glove

Kod Code	Ölçü (cm) Dim. (cm)	Koli/Adet Pcs/Ctn
65600010	Small	1
65610010	Medium	1
65620010	Large	1
65630010	X-Large	1

\* Ters yüz giyilebilir \* Reversible



» Çelik Örgü Uzun Eldiven  
S/S Chainmail Shoulder Butcher Glove

Kod Code	Koli/Adet Pcs/Ctn
65600012	1



» Çelik Örgü Önlük  
S/S Chainmail Butcher Apron

Kod Code	Ölçü (cm) Dim. (cm)	Koli/Adet Pcs/Ctn
65605660	55x70 < 1,65 m	1
65605670	56x80 > 1,65 m	1



» Mıknatıslı Bıçaklık  
Magnetic Board

Kod Code	Ölçü (cm) Dim. (cm)	Koli/Adet Pcs/Ctn
45081205	50	6
60500002	64	1



» Bıçak Sterilizatörü  
Knife Sterilizer

Kod Code	Model Model	Koli/Adet Pcs/Ctn
45000037	10 Bıçaklı / 10 Division	1

İNOVATİF MUTFAK  
INNOVATIVE KITCHEN



**NEW****100%Chef**

» Super Aladin Tütsüleyici  
Super Aladin Smoker

Kod Code	Koli/Adet Pcs/Ctn
43030165	1

\*Tabak ve fanus dahil değildir

\*Plate and cover not included



- Profesyonel Aromalandırma Tütsüleyici
- Profesyonel kullanım için özel tasarım
- Çift hazneyi kullanarak esansiyel yağları ve dumanı birleştirerek her tarifinize ekstra aroma ekler

- Professional Flavouring
- Specially designed for professional use
- Add extra scent to any recipe using the double chamber, combining essential oils and smoke

**100%Chef**

» Aladin 007 Black Edition Tütsüleyici  
Aladin 007 Black Edition Smoker

Kod Code	Koli/Adet Pcs/Ctn
43030166	1

- Kokteyllere, içeceklere ve yiyeceklere etkileyici aroma infüzyonları sağlar
- Beyaz aromatik buharlı kabarcıklar oluşturur ve bu kabarcıklar patladığında yoğun aromatik bir sis yayar
- Kaplar, cloche'lar veya bardaklarla kullanılabilir
- Nikotin içermeyen, kolayca değiştirilebilen ve aromaları karıştırmayan aroma VAPS ile çalışır.
- Buharlaştırıcıyı çıkarıp yenisiyle değiştirmek yeterlidir.

- It allows for spectacular aroma infusion in cocktails, beverages, and food,
- Presenting bubbles filled with white aromatic vapor that, when burst, release a thick aromatic mist
- It can also be used to fill containers, cloches, or glasses
- Works with nicotine-free aroma VAPS, which are easily interchangeable and do not mix flavors.
- Simply remove and replace the vaper with a new one.

**100%Chef**

» Aladin Flavour Black Tütsüleyici  
Aladin Flavour Black Smoker

Kod Code	Koli/Adet Pcs/Ctn
63050001	1

**100%Chef**

» Aladin Flavour VAP Ananas  
Aladin Flavour VAP Pinapple

Kod Code	Koli/Adet Pcs/Ctn
43030176	1

**100%Chef**

» Gastronorm Kapak 1/1 Tütsüleme Valfli  
Gastronorm Top 1/1 w/Smoking Valve

Kod Code	Koli/Adet Pcs/Ctn
43030167	1



**NEW**



- Aladin Cover, valf sistemiyle tütsü ve aromaların servis sırasında yemeklere, üzerindeki kabı kaldırmaya gerek kalmadan enjekte edilmesini sağlar
- Aladin Cover was the creator of the first model of cloches with a valve that allows the injection of smoke and aromas into dishes or containers for service, without the need to lift them.



\*Kadeh dahil değildir \*Glass not included

» Tütsüleme Fanusu **100%Chef**

Smoke Fanus

Kod Code	Ø Ölçü (cm) Ø Dim(cm)	Koli/Adet Pcs/Ctn
43030168	14	1
01DC-1002	18	1

» Kokteyl Fanusu **100%Chef**

Cocktail Cover

Kod Code	Ölçü (cm) Dim(cm)	Koli/Adet Pcs/Ctn
43030170	18,5x25	1



» Aladin Chips Meşe **100%Chef**

Aladin Chips Oak

Kod Code	Gr Gr	Koli/Adet Pcs/Ctn
43030177	80	1



» Aladin Chips Zeytin Ağacı **100%Chef**

Aladin Chips Olive Tree

Kod Code	Gr Gr	Koli/Adet Pcs/Ctn
63050003	80	1



» Aladin Chips Kayın **100%Chef**

Aladin Chips Beech Wood

Kod Code	Gr Gr	Koli/Adet Pcs/Ctn
63050002	80	1

- Köpük ve hava yaratmanın en kolay yolu
- Paslanmaz çelik nozul kolay temizlenir
- Saniiyeler içinde homojen ve stabil köpükler
- Az miktarda sıvıyla bile çalışır
- Sadece bir düğmeyle istediğiniz kadar köpük yapabilirsiniz
- Pille çalıştığından cihaz her yerde kullanılabilir

- The easiest way to create foams and airs
- Esy cleaning stainless steel nozzle
- Obtain homogeneous and stable foams within seconds
- It works even with small amounts of liquid
- Make as much foam as you want, controlling the production just by pushing a button
- The compressor is operated by batteries, so the device can be used anywhere



**100%Chef**

» Foam Kit  
Foam Kit

Kod Code	Ø Ölçü (cm) Ø Dim(cm)	Koli/Adet Pcs/Ctn
43030178	14	1

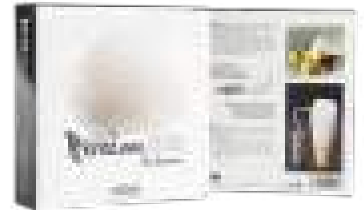

- Dijital kontrol paneli
- Ekstra hassas
- 2 bölge, 2 zaman/2 sıcaklık 99 saatlik zamanlayıcı
- Paslanmaz çelik tepsiler
- Parallexx® kurutma sistemi
- Ayarlanabilir termostat
- Digital controller
- Extreme precision
- 2 zones 2 times/2 temperatures 99 hour timer
- Stainless steel trays
- Parallexx® drying system
- Adjustable thermostat

**NEW**



Motor: 230 V / 50 Hz  
Fan: 18 cm / 600 W  
Kurutma Alanı: 1.4 m<sup>2</sup>  
Drying Sur.: 1.4 m<sup>2</sup>  
Tepsi/Tray: 38 x 38 cm

» Dehidratör PRO  
Dehydrator PRO

*Excalibur*

Kod Code	Kapasite Capacity
43030173	10 Tepsi/Trays

- 700 Watt 220V / 50hz-60hz
- Profesyonel üretim ve yüksek hacimli kullanıma uygun
- 29°C ila 74°C arasında sıcaklık düzenleyici
- 72 saate kadar zamanlayıcı
- 38 x 38 cm 10 tepsi
- 700 Watt 220V / 50hz-60hz
- Model for professional production and high volume of product
- Temperature regulator from 29 to 74°C
- Timer up to 72 hours
- 10 trays of 38 x 38

» Dehidratör Dijital  
Dehydrator Digital

*Excalibur*

Kod Code	Kapasite Capacity
43030172	10 Tepsi/Trays



87

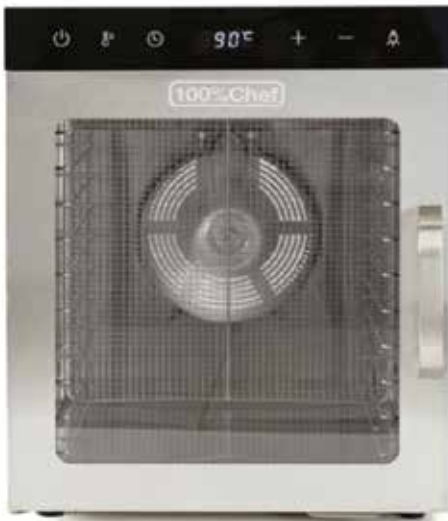

» Drycook Dehidratör  
Drycook Dehydrator

**100%Chef**

Kod Code	Kapasite Capacity
43030175	10 Tepsi/Trays

220V / 50 -60Hz 800 WATTS  
1 Fan  
10 Tepsi / Trays (30 x 28 cm)  
0.84 m<sup>2</sup> Üretim / Production

» Dehidratör 4400  
Dehydrator 4400

*Excalibur*

Kod Code	Kapasite Capacity
43030174	4 Tepsi/Trays

- 4 destek tepsisi
- 4 ağ tepsisi
- Ayarlanabilir termostat
- Yapışmaz Teflon kaplama
- 4 support trays
- 4 net trays
- Adjustable thermostat
- Non-stick Teflon Sheet

Motor: 230 V / 50 Hz  
Güç/Power: 235 W  
Tepsi/Tray: 30 x 30 cm



# Pastacılık/Pastry







90



» Yuvarlak Kalıp Keleççeli  
Springform Mould

Kod Code	Ø (cm) Ø (cm)	Koli/Adet Pcs/Ctn
64010240	24	2
64010260	26	2
64010280	28	2
64013000	30	1



» Tart Kalıbı Yuvarlak (Çıkarılabilir Taban)  
Medium Deep Fluted Mould (Loose Bottom)

Kod Code	Øxh (cm) Øxh (cm)	Koli/Adet Pcs/Ctn
64010028	28 cm	?



» Tart Kalıbı Yuvarlak  
Round Tart Mould w/Flat Edge (Fluted)

Kod Code	Ø (cm) Ø (cm)	h (mm) h (mm)	Koli/Adet Pcs/Ctn
64012825	280/250	30	2



» Tart Kalıbı Sık Yivli (Çıkarılabilir Taban)  
Round Fluted Mould (Loose Bottom, Narrow Ribs)

Kod Code	Ø (mm) Ø (mm)	h (mm) h (mm)	Koli/Adet Pcs/Ctn
64011080	100/80	30	2
64011085	100/85	18	2
64011211	120/110	20	2
64011413	140/130	25	2



» Tart Kalıbı Yuvarlak (Çıkarılabilir Taban)  
Medium Deep Fluted Mould (Loose Bottom)

Kod Code	Ø (cm) Ø (cm)	h (mm) h (mm)	Koli/Adet Pcs/Ctn
64012018	200/185	25	2
64012423	240/230	25	2
64012827	280/270	25	2



» Yuvarlak Kalıp  
Round Plain Mould

Kod Code	Ø (cm) Ø (cm)	h (mm) h (mm)	Koli/Adet Pcs/Ctn
64012120	200/175	50	2
64012124	240/210	50	2
64013295	320/295	55	2



» Yuvarlak Yivli Tart Kalıbı Seti 4'lü  
Set of 4 Fluted Round Canele

Kod Code	Ø (mm) Ø (mm)	Koli/Adet Pcs/Ctn
43030732	120	3



» Yuvarlak Yivli Tart Kalıbı  
Fluted Round Canele

Kod Code	Ø (mm) Ø (mm)	Koli/Adet Pcs/Ctn
64310045	45	12
64310060	60	12
64310100	100	12
64310120	120	12



» Exoglass Kiş Kalıbı Yuvarlak 12 Lı  
Exoglass Quiche Mould 12 Pieces

Kod Code	Øxh (mm) Øxh (mm)	Koli/Adet Pcs/Ctn
77501020	100x20	12



» Gondol Kalıp Yivli  
Fluted Oval Boat Mould

Kod Code	Ölçü (mm) Dim. (mm)	Koli/Adet Pcs/Ctn
64018040	80x40	12



» Gondol Kalıp Düz  
Plain Oval Boat Mould

Kod Code	Ölçü (mm) Dim. (mm)	Koli/Adet Pcs/Ctn
64016020	60x20	12
64018033	80x33	12
64011043	100x43	12
64011350	120x50	12



» Brioche Kalıp  
Brioche Mould

Kod Code	Ölçü (mm) Dim. (mm)	Koli/Adet Pcs/Ctn
64016028	60x28	12
64011055	100x55	12



» Kubbe Yivli Mini Kalıp  
Ribbed Dome Mini Mould

Kod Code	Ölçü (mm) Dim. (mm)	Koli/Adet Pcs/Ctn
64010045	45	12

» Oval Yivli Mini Kalıp  
Ribbed Oval Mini Mould

Kod Code	Ölçü (mm) Dim. (mm)	Koli/Adet Pcs/Ctn
64110045	45	12

» Kare Yivli Mini Kalıp  
Ribbed Square Mini Mould

Kod Code	Ölçü (mm) Dim. (mm)	Koli/Adet Pcs/Ctn
64210045	35x35	12



» Exoglass Oblong Kalıp  
Exoglass Oblong Mould

Kod Code	Ölçü (mm) Dim. (mm)	Koli/Adet Pcs/Ctn
77501320	130x40x20	6



» Dariole Kalıp  
Dariole/Rum Baba Mould

Kod Code	Ø (mm) Ø (mm)	Koli/Adet Pcs/Ctn
64010060	60	12



» Soufle Kalıp  
Souffle Mould

Kod Code	Ø (mm) Ø (mm)	Koli/Adet Pcs/Ctn
64010080	80	3



» Muffin Kalıbı 6' lı  
Muffin 6 Partition

Kod Code	Ölçü (mm) Dim. (mm)	Koli/Adet Pcs/Ctn
43030084	270x185x29	2



» Muffin Kalıbı 12' lı  
Muffin 12 Partition

Kod Code	Ölçü (mm) Dim. (mm)	Koli/Adet Pcs/Ctn
43030077	270x360x30	2



» Ekmek Kalıbı  
Loaf Mould

Kod Code	Ölçü (mm) Dim. (mm)	Koli/Adet Pcs/Ctn
43030733	250x110x64	2
43030734	300x110x64	2

92



» Pişirme Tepsisi  
Baking Sheet

Kod Code	Ölçü (mm) Dim. (mm)	h (mm) h (mm)	Koli/Adet Pcs/Ctn
64014035	400x300	35	2
64014050	400x300	50	2



» Tost Ekmek Kalıbı  
Toastbrot w/Lid

Kod Code	Ölçü (mm) Dim. (mm)	Koli/Adet Pcs/Ctn
64012500	250x76	2
64010400	400x90	2

**NEW**



» Kalp İkiz Tekli Pasta Kalıbı  
Heart Twin Single Cake Mould

Kod Code	Ölçü (mm) Dim. (mm)	Kapasite Capacity
43030149	250x140x60	1200 ml



» Kalp Mini  
Heart Mini

Kod Code	Ölçü (mm) Dim. (mm)	Kapasite Capacity
43030062	40x30x20	10x18 ml



» Kalp  
Heart

Kod Code	Ölçü (mm) Dim. (mm)	Kapasite Capacity
43030094	71x66x38	12x100 ml



» Kalp Fiyonk  
Heart Bow

Kod Code	Ölçü (mm) Dim (mm)	Kapasite (ml) Capacity (ml)
43030148	73x66x36	12x90 ml



» Je T'aime  
Je T'aime

Kod Code	Ölçü (mm) Dim (mm)	Kapasite (ml) Capacity (ml)
43030152	80x80x33	12x140 ml



» La Vie En Rose  
La Vie En Rose

Kod Code	Ø (mm) Ø (mm)	Kapasite (ml) Capacity (ml)
43030153	78x26	12x100 ml

93

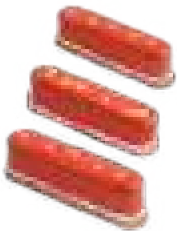

» Fashion Éclairé  
Fashion Éclairé

Kod Code	Ölçü (mm) Dim. (mm)	Kapasite Capacity
43030093	125x28x28	14x90 ml



» Finger Éclairé  
Finger Éclairé

Kod Code	Ölçü (mm) Dim. (mm)	Kapasite Capacity
43030110	128x30x28	14x90 ml



» Miss  
Miss

Kod Code	Ölçü (mm) Dim. (mm)	Kapasite Capacity
43030100	78x48x33	15x90 ml

**NEW**

 » Planet  
Planet

Kod Code	Ölçü (mm) Dim. (mm)	Kapasite Capacity
43030102	Ø 66x34	12x93 ml

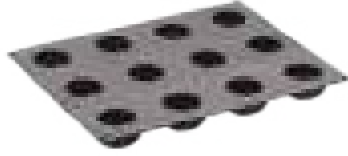
 » Truffles  
Truffles

Kod Code	Ölçü (mm) Dim (mm)	Kapasite Capacity
43030196	Ø 60	20x110 ml

 » Donut  
Donut

Kod Code	Ölçü (cm) Dim (cm)	Kapasite Capacity
43030190	Ø 65x34	12x90 ml

 » Honore  
Honore

Kod Code	Ø (mm) Ø (mm)	Kapasite (ml) Capacity (ml)
43030154	72x40	12x100 ml



94

 » Plummy  
Plummy

Kod Code	Ölçü (mm) Dim. (mm)	Kapasite Capacity
43030189	360x50x36	5x410 ml

 » Domino  
Domino

Kod Code	Ölçü (mm) Dim (mm)	Kapasite (ml) Capacity (ml)
43030155	126x33x32	14x80 ml



**NEW**



» Disk  
Disc

Kod Code	Ölçü (mm) Dim. (mm)	Kapasite Capacity
43030122	Ø 110x3,5	6x33 ml



» Disk Küçük  
Disc Small

Kod Code	Ölçü (mm) Dim. (mm)	Kapasite Capacity
43030123	Ø 90x3,5	11x22 ml



» Charlotte  
Charlotte

Kod Code	Ø (mm) Ø (mm)	Kapasite (ml) Capacity (ml)
43030150	75x45	12x140 ml



» Nuage  
Nuage

Kod Code	Ø (mm) Ø (mm)	Kapasite (ml) Capacity (ml)
43030151	75x45	12x140 ml



» Polly  
Polly



Kod Code	Øxh (mm) Øxh (mm)	Kapasite (ml) Capacity (ml)
43030023	78x56x43	12x90 ml



» Jasmine  
Jasmine



Kod Code	Øxh (mm) Øxh (mm)	Kapasite (ml) Capacity (ml)
43030059	65x57	12x100 ml

**NEW**

 » Daisy  
Daisy

Kod Code	Øxh (mm) Øxh (mm)	Kapasite (ml) Capacity (ml)
43030079	74x15	24x65 ml

 » Gonca  
Rosebud

Kod Code	Øxh (mm) Øxh (mm)	Kapasite (ml) Capacity (ml)
43030086	70x42	24x130 ml

 » Silindir  
Cylinder

Kod Code	Ölçü (cm) Dim (cm)	Kapasite Capacity
43030195	Ø 65x40	24x130 ml



96

 » Quenelle  
Quenelle

Kod Code	Ölçü (mm) Dim. (mm)	Kapasite Capacity
43030103	66x33x30	49x32 ml

 » Mini-Savarin  
Mini Savarin

Kod Code	Ölçü (mm) Dim. (mm)	Kapasite Capacity
43030092	Ø 40x13	77x13 ml

 » Guglhupf  
Guglhupf

Kod Code	Ölçü (mm) Dim. (mm)	Kapasite Capacity
43030088	Ø 70x33	24x70 ml

 » Oval  
Oval

Kod Code	Ölçü (mm) Dim. (mm)	Kapasite Capacity
43030068	85x50x43	25x100 ml

 » Brioche  
Brioche

Kod Code	Ölçü (mm) Dim. (mm)	Kapasite Capacity
43030051	Ø 79x37	24x100 ml

 » Madlen Mini  
Madlen Mini

Kod Code	Ölçü (mm) Dim. (mm)	Kapasite Capacity
43030061	52x33x15	72x15 ml

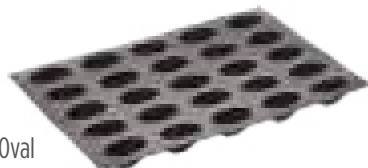

**NEW**



» Dörtgen Mini  
Rectangle Mini

Kod Code	Ölçü (mm) Dim. (mm)	Kapasite Capacity
43030054	49x26x11	90x11 ml

» Piramit  
Pyramid

Kod Code	Ölçü (mm) Dim. (mm)	Kapasite Capacity
43030058	70x70x45	35x80 ml

» Sufle  
Souffle

Kod Code	Ölçü (mm) Dim. (mm)	Kapasite Capacity
43030080	44x28	40x28 ml



» Eclips  
Eclips

Kod Code	Ölçü (mm) Dim. (mm)	Kapasite Capacity
43030064	Ø 72x41	24x110 ml

» Yarım Küre Mini  
Hemisphere Mini

Kod Code	Ölçü (mm) Dim. (mm)	Kapasite Capacity
43030060	Ø 42x21	12x10 ml

» Yarım Küre Orta  
Hemisphere Medium

Kod Code	Øxh (mm) Øxh (mm)	Kapasite (ml) Capacity (ml)
43030089	42x21	77x20 ml

97



» Muffin Büyük  
Muffin Big

Kod Code	Ölçü (mm) Dim. (mm)	Kapasite Capacity
43030096	85x50	24x235 ml

» Muffin Mini  
Muffin Mini

Kod Code	Ölçü (mm) Dim. (mm)	Kapasite Capacity
43030055	50x28	54x45 ml

» Muffin  
Muffin

Kod Code	Ölçü (mm) Dim. (mm)	Kapasite Capacity
43030067	70x40	24x130 ml



» Swirl  
Swirl

Kod	Øxh (mm)	Kapasite (ml)
Code	Øxh (mm)	Capacity (ml)
43030117	75x38	6x110 ml



» Brioche  
Brioche

Kod	Øxh (mm)	Kapasite (ml)
Code	Øxh (mm)	Capacity (ml)
43030118	79x30	6x109 ml



» Yarım Küre  
Hemisphere

Kod	Øxh (mm)	Kapasite (ml)
Code	Øxh (mm)	Capacity (ml)
43030012	80x40	5x134 ml

98



» Yarım Küre  
Hemisphere

Kod	Øxh (mm)	Kapasite (ml)
Code	Øxh (mm)	Capacity (ml)
43030013	70x35	6x89 ml



» Tartelet  
Tartelet

Kod	Øxh (mm)	Kapasite (ml)
Code	Øxh (mm)	Capacity (ml)
43030119	50x15	15x20 ml



» Yarım Küre  
Hemisphere

Kod	Øxh (mm)	Kapasite (ml)
Code	Øxh (mm)	Capacity (ml)
43030015	60x30	8x57 ml



» Yarım Küre  
Hemisphere

Kod	Øxh (mm)	Kapasite (ml)
Code	Øxh (mm)	Capacity (ml)
43030016	50x23	15x33 ml



» Yarım Küre  
Hemisphere

Kod	Øxh (mm)	Kapasite (ml)
Code	Øxh (mm)	Capacity (ml)
43030017	34x16	24x13 ml



» Muffin Mini  
Muffin Mini

Kod	Øxh (mm)	Kapasite (ml)
Code	Øxh (mm)	Capacity (ml)
43030021	50x28	11x43 ml



» Muffin  
Muffin

Kod Code	Øxh (mm) Øxh (mm)	Kapasite (ml) Capacity (ml)
43030022	70x40	6x130 ml

» Gül Mini  
Mini Rose

Kod Code	Øxh (mm) Øxh (mm)	Kapasite (ml) Capacity (ml)
43030034	75x40	6x90 ml

» Fiorentin  
Fiorentin

Kod Code	Ölçü (mm) Dim. (mm)	Kapasite Capacity
43030053	35x5	24x5 ml



» Tartalet  
Tarlette

Kod Code	Øxh (mm) Øxh (mm)	Kapasite (ml) Capacity (ml)
43030031	80x18	6x85 ml



» Kalp Küçük  
Heart Small

Kod Code	Øxh (mm) Øxh (mm)	Kapasite (ml) Capacity (ml)
43030032	60x75x67	8x110 ml

99



» Kalp Orta  
Heart Medium

Kod Code	Øxh (mm) Øxh (mm)	Kapasite (ml) Capacity (ml)
43030071	65x60x35	8x97 ml

» Piramit  
Pyramid

Kod Code	Øxh (mm) Øxh (mm)	Kapasite (ml) Capacity (ml)
43030018	71x71x40	6x92 ml

» Oval  
Oval

Kod Code	Øxh (mm) Øxh (mm)	Kapasite (ml) Capacity (ml)
43030020	55x33x20	16x28 ml



» Fiber Örtü Delikli  
Baking Sheet With Holes

Kod Code	Ölçü (cm) Dim. (cm)	Koli/Adet Pcs/Ctn
43030070	40x60	1

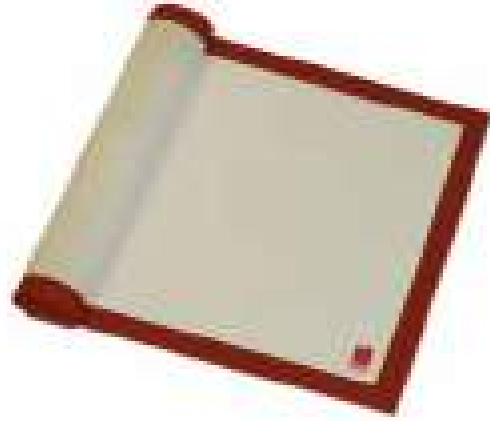

» GN Fiber Örtü  
GN Baking Sheet

Kod Code	Ölçü (cm) Dim. (cm)	Koli/Adet Pcs/Ctn
43030171	31,5x52	1

100

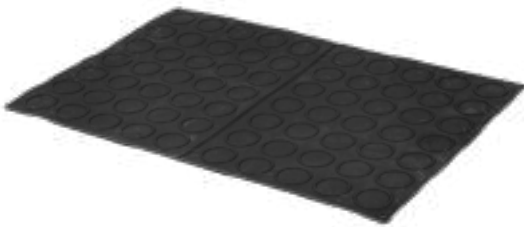

» Fiber Örtü Makaron  
Macaron Baking Sheet

Kod Code	Ölçü (cm) Dim. (cm)	Kapasite Capacity	Koli/Adet Pcs/Ctn
43035000	40x60	70 bölme 70 partition	6

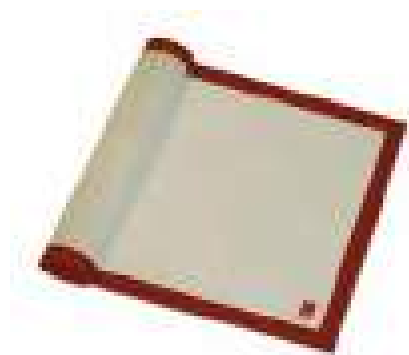

» Fiber Örtü  
Baking Sheet

Kod Code	Ölçü (cm) Dim. (cm)	Koli/Adet Pcs/Ctn
43030069	40x60	6

**NEW**



» Elips  
Elliptical

Kod Code	Ölçü (mm) Dim (mm)	Kapasite (g) Capacity (g)
43030120	41x29x13	24x10 g



» Yarım Küre  
Hemisphere

Kod Code	Ø (mm) Ø (mm)	Kapasite (g) Capacity (g)
43030124	35x17,5	24x11 g



» Kalp  
Heart

Kod Code	Ölçü (mm) Dim (mm)	Kapasite (g) Capacity (g)
43030125	25x28x16	24x7 g



» Prizma  
Prisma

Kod Code	Ø (mm) Ø (mm)	Kapasite (g) Capacity (g)
43030126	25x14	24x7 g



» Kapsül  
Capsule

Kod Code	Ø (mm) Ø (mm)	Kapasite (g) Capacity (g)
43030127	25x25	21x10 g



» Vertigo  
Vertigo

Kod Code	Ø (mm) Ø (mm)	Kapasite (g) Capacity (g)
43030128	30x18	21x10 g

101



» Babil  
Babil

Kod Code	Ölçü (mm) Dim (mm)	Kapasite (g) Capacity (g)
43030129	32x23x19	21x10 g



» Intrigo  
Intrigo

Kod Code	Ölçü (mm) Dim (mm)	Kapasite (g) Capacity (g)
43030130	30x30x18	21x10 g



» Ring  
Ring

Kod Code	Ø (mm) Ø (mm)	Kapasite (g) Capacity (g)
43030131	31x20	21x10 g

**NEW**

 » Gift  
 Gift

Kod Code	Ø (mm) Ø (mm)	Kapasite (g) Capacity (g)
43030132	31x20	21x10 g

 » Core  
 Core

Kod Code	Ölçü (mm) Dim (mm)	Kapasite (g) Capacity (g)
43030133	30x30x17	21x10 g

 » Crown  
 Crown

Kod Code	Ø (mm) Ø (mm)	Kapasite (g) Capacity (g)
43030134	28x17	21x10 g



102

 » Kupola  
 Kupola

Kod Code	Ø (mm) Ø (mm)	Kapasite (g) Capacity (g)
43030135	26x23,5	21x10 g

 » Yuvarlak Artisan  
 Round Artisan

Kod Code	Ø (mm) Ø (mm)	Kapasite (g) Capacity (g)
43030136	29x14	21x10 g

 » Dikdörtgen Artisan  
 Rectangle Artisan

Kod Code	Ölçü (mm) Dim (mm)	Kapasite (g) Capacity (g)
43030137	37x16x14	21x10 g

 » Oval Artisan  
 Oval Artisan

Kod Code	Ölçü (mm) Dim (mm)	Kapasite (g) Capacity (g)
43030138	37x21x14	21x10 g

 » Kare Artisan  
 Square Artisan

Kod Code	Ölçü (mm) Dim (mm)	Kapasite (g) Capacity (g)
43030139	26x26x13	21x10 g



**NEW**



» Peak  
Peak

Kod Code	Ölçü (mm) Dim (mm)	Kapasite (g) Capacity (g)
43030140	43x25x17	21x10 g



» Crescent  
Crescent

Kod Code	Ölçü (mm) Dim (mm)	Kapasite (g) Capacity (g)
43030141	33x28x20	21x10 g



» Twin  
Twin

Kod Code	Ölçü (mm) Dim (mm)	Kapasite (g) Capacity (g)
43030142	30x29x17	21x10 g



» Hollow  
Hollow

Kod Code	Ölçü (mm) Dim (mm)	Kapasite (g) Capacity (g)
43030143	38x26x18	21x10 g



» Oval Çatlak  
Oval Crack

Kod Code	Ölçü (mm) Dim (mm)	Kapasite (g) Capacity (g)
43030144	41x24x12,5	18x10 g



» Dörtgen Çatlak  
Rectangle Crack

Kod Code	Ölçü (mm) Dim (mm)	Kapasite (g) Capacity (g)
43030145	39x20x12,5	18x10 g

103



» Yuvarlak Çatlak  
Round Crack

Kod Code	Ø (mm) Ø (mm)	Kapasite (g) Capacity (g)
43030146	33x12,5	18x10 g

- Şoka dayanıklı Polipropilen gövde
- Sökülebilir paslanmaz çelik iç hazne
- Çikolatayı eritir ve sıvı halde kalmasını sağlar
- Özel rezistansı sayesinde homojen ısı dağılımı
- 25-90°C ısı aralığı
- Yalıtımlı gövde maksimum enerji tasarrufu sağlar
- Ağırlık : 1,8 Kg

- Multi-Purpose appliance for melting and keeping chocolate, fondant, toppings, sauces, jelly, etc.
- Non detachable stainless steel bowl
- Heat is uniformly distributed thanks to special resistor
- Electronic regulation 25 to 90°C for a wide range of uses. Accuracy  $\pm 1,5^\circ\text{C}$
- Reduced energy consumption thanks to efficient insulation
- Weight: 1.8 kg

» Yuvarlak Çikolata Eritme Makinesi

Chocolate Melting Machine

Kod Code	Øxh (mm) Øxh (mm)	Kapasite Capacity	Koli/Adet Pcs/Ctn
77550010	254x188	3,5 Lt	1



104

- Yumurta, sıvı yağ, tereyağı, çikolata karışımı, soslar vb.
- 60 Watt güç
- Fırın tepsilerini, kalıpları yağlamakta ve yumurta akı püskürtmekte kolaylık sağlar
- R6 yuvarlak ve F7 düz başlık ile birlikte gelir

- Applying egg, oil, butter, glaze, fondant, chocolate mix, marinades and sauces etc.
- 60 Watts of power
- Greasing baking sheets & tins, and spraying butter etc.
- It comes with R6 round & F7 flat

\* Viskozite / Viscosity: max 80 DIN/sec

\* Ürün aktarım miktarı / Delivery Rate\*: 250g/min (water)



» Gıda Püskürtme Makinesi

Food Spray Gun

Kod Code	Kapasite Capacity	Koli/Adet Pcs/Ctn
43031050	0,7 lt	1

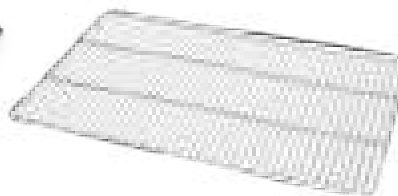

» Çikolata Firkete Takımı

Chocolate Dipping Forks

Kod Code	Model Model	Koli/Adet Pcs/Ctn
43230010	10'lü/10 pcs	1

» Ayaklı Glasso Teli

Cooling Rack

Kod Code	Ölçü(cm) Dims(cm)	Koli/Adet Pcs/Ctn
43034060	40x60	1

» Çikolata Spatulası

Chocolate Spatula

Kod Code	Ölçü (cm) Dim. (cm)	Koli/Adet Pcs/Ctn
43031051	20	1



» Püskürtme Tabancası 7 cc  
Compressor Airbrush 7 cc

Kod Code	Koli/Adet Pcs/Ctn
77550013	1

- Teflon piston ile yağlama ihtiyacı olmadan kolay kullanım
- Sabit çalışma basıncı
- Maksimum 4 Bar basınçta dakikada 23-25 litre hava üretimi
- Airbrush için bağlantı kablosu dahildir

- Easy usage by the Teflon piston without lubrication oil
- Constant working pressure
- Generates 23-25 liters of air per minute at a maximum pressure of 4 Bar
- The connection cable for the airbrush is included

Güç / Power : 1/5 HP  
Voltaj / Voltage : 220-240V / 50HZ  
110-120V/60HZ 220V / 60HZ



» Püskürtme Kompresörü 2,5 Bar  
Pastry Compressor 2,5 Bar

Kod Code	Koli/Adet Pcs/Ctn
77550012	1

- \* Püskürtme tabancası dahildir.
- \* Nozzle is included.



105

» Gitar 3 Çerçevesi Set  
Single Guitar Set With 3 Frames

NEW

Kod Code	Ölçü (cm) Dim. (cm)	Koli/Adet Pcs/Ctn
77503546	60x40x10	1

- \* Kesim mesafeleri: 22,5 - 30 - 37,5 mm
- \* Cutting distances: 22,5 - 30 - 37,5 mm

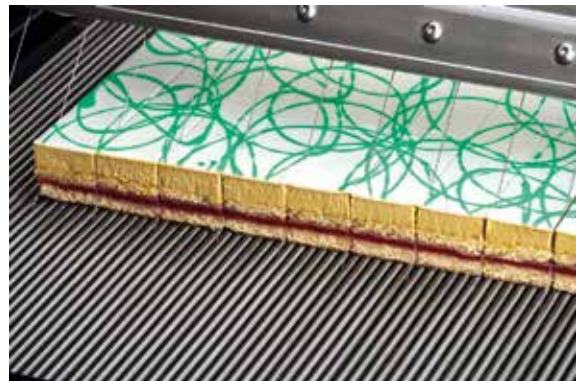
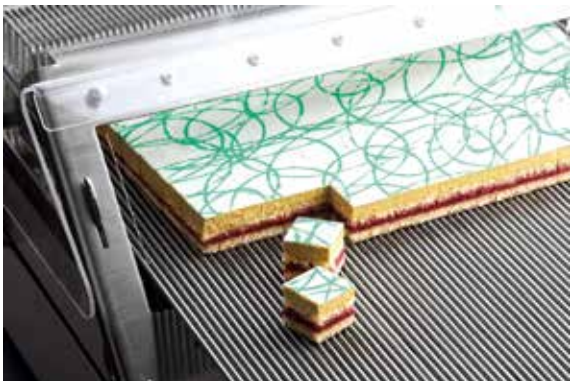



» Çember h: 5 cm  
Cake Rings h:5 cm

Kod Code	Ø (cm) Ø (cm)	Koli/Adet Pcs/Ctn
43030508	8	6
43030510	10	6
43030514	14	6
43030516	16	6
43030518	18	3
43030520	20	3
43030522	22	3
43030524	24	3
43030526	26	3
43030528	28	3



» Çember h: 7 cm  
Cake Rings h:7 cm

Kod Code	Ø (cm) Ø (cm)	Koli/Adet Pcs/Ctn
43030708	8	6
43030710	10	6
43030714	14	6
43030716	16	6
43030718	18	3
43030720	20	3
43030722	22	3
43030724	24	3
43030726	26	3
43030728	28	3



» Çember Mousse  
Cake Rings Mousse

Kod Code	Øxh(cm) Øxh(cm)	Koli/Adet Pcs/Ctn
43030916	16x9	6
43030918	18x9	6
43030920	20x9	6
43030922	22x9	6
43031218	10x12	6
43031220	20x12	6
43031222	22x12	6
43031224	24x12	6



» Çember Vacherin h:6  
Cake Rings Vacherin h:6

Kod Code	Ø (cm) Ø (cm)	Koli/Adet Pcs/Ctn
43030610	10	12
43030612	12	12
43030614	14	12
43030616	16	12
43030618	18	12
43030620	20	12
43030622	22	6
43030624	24	6
43030626	26	6
43030628	28	6
43030630	30	6



» Çember Enremments h:3,5  
Cake Rings Enremments h:3,5

Kod Code	Ø (cm) Ø (cm)	Koli/Adet Pcs/Ctn
43030311	11	12
43030314	14	12
43030315	15	12
43030316	16	12
43030318	18	12
43030320	20	12
43033522	22	6
43030324	24	6
43030326	26	6
43030328	28	6
43030330	30	6



» Çember Mousse h:4,5  
Cake Rings Mousse h:4,5

Kod Code	Ø (cm) Ø (cm)	Koli/Adet Pcs/Ctn
43030407	7	12
43030475	7,5	12
43030408	8	12
43030410	10	12
43030412	12	12
43030414	14	12
43034516	16	12
43030418	18	12
43030420	20	12
43030422	22	6
43030424	24	6
43030426	26	6
43030428	28	6



» Tart Çemberi (Kıvrık Kenarlı)  
S/S Tart Ring Rolled Edges

Kod Code	Øxh(mm) Øxh(mm)	Koli/Adet Pcs/Ctn
77507016	70x16	6
77501420	140x20	6
77501820	180x20	6
77502020	200x20	6



» Kare Kalıp  
Square Rings

Kod Code	Ölçü (cm) Dim. (cm)	Koli/Adet Pcs/Ctn
43031114	14x14x11	6
43031216	16x16x12	6
43031420	20x20x14	6



» Kare Kalıp  
Square Rings

Kod Code	Ölçü (mm) Dim. (mm)	Koli/Adet Pcs/Ctn
43030413	130x130x45	6
43030416	160x160x45	6
43030419	190x190x45	6
43030421	210x210x45	6
43030423	230x230x45	6

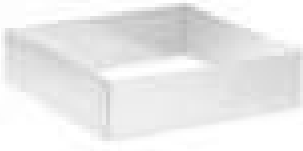

» Kare Kalıp h: 7 cm  
Square Rings h: 7 cm

Kod Code	Ölçü (cm) Dim. (cm)	Koli/Adet Pcs/Ctn
43031710	10x10	6
43031713	13x13	6
43031715	15x15	6
43031717	17x17	6
43031719	19x19	3
43031722	22x22	3
43031724	24x24	3
43031726	26x26	3
43031728	28x28	3
43031730	30x30	3



» Kare Kalıp h: 10 cm  
Square Rings h: 10 cm

Kod Code	Ölçü (cm) Dim. (cm)	Koli/Adet Pcs/Ctn
43031010	10x10	6
43031013	13x13	6
43031015	15x15	6
43031017	17x17	6
43031019	19x19	3
43031022	22x22	3
43031024	24x24	3
43031026	26x26	3
43031028	28x28	3
43031030	30x30	3



» Kare Kalıp  
Square Rings

Kod Code	Ölçü (mm) Dim. (mm)	Koli/Adet Pcs/Ctn
43030356	56x56x30	6
43035603	60x50x30	6
43032802	80x25x25	6
43034104	124x43x40	6
43034803	80x40x30	6
43031123	110x25x30	6
43031632	164x32x25	6



» Kare Kalıp  
Square Rings

Kod Code	Ölçü (mm) Dim. (mm)	Koli/Adet Pcs/Ctn
43030312	120x120x35	6
43030317	170x170x35	6
43030322	225x225x35	6
43030327	275x275x35	6
43030333	330x330x35	6
43030338	380x380x35	6



» Dörtgen Kalıp  
Rectangular Rings

Kod Code	Ölçü (mm) Dim. (mm)	Koli/Adet Pcs/Ctn
43034602	565x365x25	6
43034603	565x365x35	6
43034604	565x365x45	6
43035303	496x290x35	6
43035304	496x290x45	6
43033403	375x275x35	6
43033404	375x275x45	6



» Dörtgen Kalıp  
Rectangular Rings

Kod Code	Ölçü (mm) Dim. (mm)	Koli/Adet Pcs/Ctn
43034102	370x110x25	6
43036102	570x110x25	3
43033704	370x90x40	6
43036104	560x90x40	3
43036145	570x95x45	3

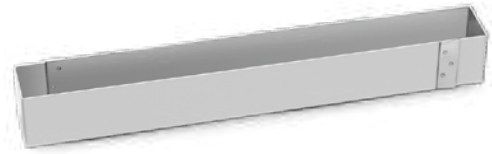

» Dörtgen Kalıp  
Rectangular Rings

Kod Code	Ölçü (mm) Dim. (mm)	Koli/Adet Pcs/Ctn
43036107	570x70x70	3



» Ayarlı Çember (Çelik)  
Adjustable Ring

Kod Code	Ölçü (cm) Dim. (cm)	Koli/Adet Pcs/Ctn
43030010	15-30	1



» Ayarlı Kare Kalıp (Çelik)  
Adjustable Square Cake Mould

Kod Code	Ölçü (cm) Dim. (cm)	H (cm) H (cm)	Koli/Adet Pcs/Ctn
43031630	16x16-30x30	4	1
43030007	20x20-40x40	5	1
43030006	30x30-60x60	5	1
43030009	20x20-40x40	7	1
43030008	30x30-60x60	7	1



» Ayarlı Dörtgen Kalıp (Çelik)  
Adjustable Rectangle Cake Mould

Kod Code	Ölçü (cm) Dim. (cm)	H (cm) H (cm)	Koli/Adet Pcs/Ctn
43032036	20x15-36x27	4,5	2
43033056	30x20-56x36	4,5	2
43032140	21x11,5-40x21,5	7,5	2



» Damla Kalıp  
Drop Mould

Kod Code	Ölçü (cm) Dim. (cm)	Koli/Adet Pcs/Ctn
43032012	20x12x4	?
43032314	23x14,5x4	
43032616	26x16x4	
43032918	29x18,5x4	



» Kalp Kalıp  
Heart

Kod Code	Ölçü (mm) Dim. (mm)	h (mm) h (mm)	Koli/Adet Pcs/Ctn
43037055	70x55	30	6
43038070	80x70	45	
64018585	85x85	30	

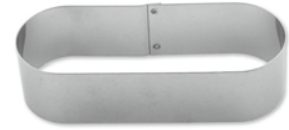

» Oblong Kalıp  
Oblong

Kod Code	Ölçü (mm) Dim. (mm)	h (mm) h (mm)	Koli/Adet Pcs/Ctn
64011140	110x40	110x40	6



» Pandispanya Testeresi  
Genoise Saw

Kod Code	Model Model	Koli/Adet Pcs/Ctn
43031052	2 Testereli Set of 2 Spared Blades	1



» Yuvarlak Metal Volovan 6'lı Set  
Round Cutter Steel Set of 6

Kod Code	Ölçü (mm) Dim. (mm)	Koli/Adet Pcs/Ctn
43030105	Dişli/Fluted	1
43030104	Düz/Plain	1



» Kare Metal Volovan 6'lı Set  
Square Cutter Steel Set of 6

Kod Code	Ölçü (mm) Dim. (mm)	Koli/Adet Pcs/Ctn
43030107	Dişli/Fluted	1
43030106	Düz/Plain	1

## Pastacılık Ekipmanları / Pastry Equipments



» Rulet  
Roller

Kod Code	Model Model	Koli/Adet Pcs/Ctn
77501110	Kafes Kesici / Pastry Roller	4
77501120	Delici / Spiked Pastry	4



» Oklava (Polietilen)  
Rollin Pin (Polyethylene)

Kod Code	Ölçü (cm) Dim. (cm)	Koli/Adet Pcs/Ctn
49020025	Ø 25	1
49010035	Ø 35	1



» Saplı Merdane (Polietilen)  
Roller (Polyethylene)

Kod Code	Ölçü (cm) Dim. (cm)	Model Model	Koli/Adet Pcs/Ctn
49070250	Ø 7x25+20	Küçük Small	1
49080330	Ø 8x33+20	Orta Medium	1
49098380	Ø 9x38+20	Büyük Big	1



110 » Kruvasan Merdane  
Croissant Roller Cutter

Kod Code	Ölçü (cm) Dim. (cm)	Koli/Adet Pcs/Ctn
49270430	43x8	1



» Un Elek (S/S)  
Flour Sifter (S/S)

Kod Code	Koli/Adet Pcs/Ctn
43133000	2



» Kakao/Pudra Şekeri Shaker  
Shaker

Kod Code	Model Model	Koli/Adet Pcs/Ctn
62021789	Büyük Delikli 7 cm Big Hole 7 cm	6
62023789	Küçük Delikli 7 cm Small Hole 7 cm	6
62022789	Süzgeç 7 cm Mesh 7 cm	6

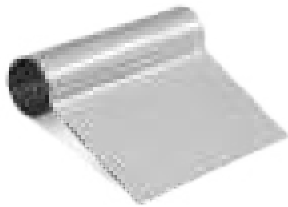

» Hamur Kazıyıcısı (Paslanmaz Saplı)  
Dough Scraper (S/S Handle)

Kod Code	Ölçü (cm) Dim. (cm)	Koli/Adet Pcs/Ctn
62010006	13x11	6



» Hamur Kazıyıcısı (Plastik)  
Dough Scraper (Plastic)

Kod Code	Ölçü (cm) Dim. (cm)	Koli/Adet Pcs/Ctn
62110006	13X11	6

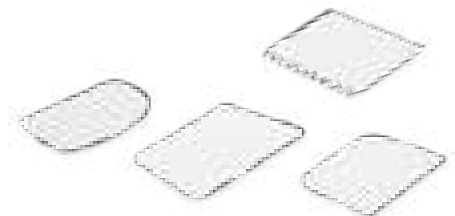

» Hamur Kazıyıcı 4'lü Set (Plastik)  
Dough Scraper 4 pcs Set (Plastic)

Kod Code	Ölçü (cm) Dim. (cm)	Koli/Adet Pcs/Ctn
62110007	15,5x9	6



» Ekmek Jileti  
Disposable Baker's Blade

Kod Code	Ölçü (cm) Dim. (cm)
43131000	14x4

- Monoblok krom kaplı çelik gövde
- 3 bıçak: Lazanya, 2 mm Fettuccine ve 6,5 mm Tagliatelle
- Çıkarılabilir tutma kolu
- Monoblock chrome-plated steel body
- 3 cutters: Smooth Lasagne, 2 mm Fettuccine and 6,5 mm Tagliatelle
- Detachable handle

NEW

imperia



» Manuel Erişte Makinesi  
Manual Pasta Maker *Made in Italy*

Kod Code	Ölçü (cm) Dim. (cm)	Koli/Adet Pcs/Ctn
63010410	19x16x12	1



» Ekmek Mayalama Sepeti Oval  
Banneton Oval

Kod Code	Ölçü (cm) Dim. (cm)	Koli/Adet Pcs/Ctn
43032213	22x13,5x8	6
43032514	25x14x9	6
43032815	28x15x9	6



» Ekmek Mayalama Sepeti Yuvarlak  
Banneton Round

Kod Code	Ölçü (cm) Dim. (cm)	Koli/Adet Pcs/Ctn
43032088	20x8	6
43032299	22x9	6
43032599	25x9	6



» Ekmek Mayalama Sepeti Dörtgen  
Banneton Rectangle

Kod Code	Ölçü (cm) Dim. (cm)	Koli/Adet Pcs/Ctn
43033013	30x13,5x8,5	6

NEW



» Bezli Ekmek Mayalama Sepeti Oval  
Banneton Oval w/Cloth

Kod Code	Ölçü (cm) Dim. (cm)	Koli/Adet Pcs/Ctn
43042213	22x13,5x8	6
43042514	25x14x9	6
43042815	28x15x9	6
43043013	30x13,5x8	6

NEW



» Bezli Ekmek Mayalama Sepeti Yuvarlak  
Banneton Round w/Cloth

Kod Code	Ölçü (cm) Dim. (cm)	Koli/Adet Pcs/Ctn
43042008	20x8	6
43042209	22x9	6
43042509	25x9	6



NEW



» Kabartma Kabı  
Cream Whipper

Kod Code	Kapasite Capacity	Koli/Adet Pcs/Ctn
43040048	0,5 Lt	1
43040049	1,0 Lt	1
43040050	10x8 gr Kabartma Tüpü 10x8 gr Cream Charger	1



» Kabartma Kabı  
Cream Whipper



Kod Code	Kapasite Capacity	Koli/Adet Pcs/Ctn
43030045	0,5 Lt	1
43030046	1,0 Lt	1
43030047	10x8 gr Kabartma Tüpü 10x8 gr Cream Charger	1

\* 1 kabartma tüpü ile 0,5 litreye kadar krema ve benzeri ürünler hazırlanabilir.  
\*One cream charger whips up to 0.5 litres of liquid whipping cream or similar product.



» Krema Torbası  
Pastry Bag



Kod Code	Ölçü (cm) Dim. (cm)	Koli/Adet Pcs/Ctn
43030038	40	6
43030039	46	6
43030040	50	6
43030041	55	6
43030042	60	6
43030043	65	6

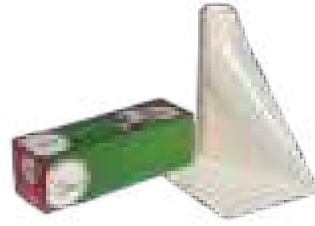

» Krema Torbası Tek Kullanımlık 72'li  
Pastry Bag 72 Pcs.

Kod Code	Ölçü (cm) Dim. (cm)	Koli/Adet Pcs/Ctn
43030044	50x26	6



» 12'li Duy Seti (PC)  
Icing Tip Set 12 Pcs. (PC)

Kod Code	Model Model	Koli/Adet Pcs/Ctn
43030073	PC	1
43030072	Plastik	



» 52'li Duy Seti (Paslanmaz Çelik)  
Icing Tip Set 52 Pcs. (S/S)

Kod Code	Koli/Adet Pcs/Ctn
43031008	1



» Büyük Boy Duy Seti 36'lı (S/S)  
Icing Tip Big Set 36 Pcs.(S/S)

Kod Code	Koli/Adet Pcs/Ctn
43031009	1

113



NEW

» Sos Şiringası  
Sauce Syringe

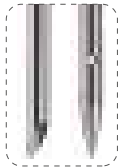

Kod Code	Koli/Adet Pcs/Ctn
64010070	1



» Fırça (Sentetik)  
Brush

Kod Code	No No	Ölçü (cm) Dim. (cm)	Koli/Adet Pcs/Ctn
43600002	2	22x4	6
43600003	3	22,5x6,5	6



» Silikon Fırça  
Silicone Brush

NEW

Kod Code	Ölçü (cm) Dim. (cm)	Koli/Adet Pcs/Ctn
52030006	21x3,5	6



NEW



» Spatula Termometre  
Spatula Thermometer

Kod Code	Ölçü (cm) Dim. (cm)	Koli/Adet Pcs/Ctn
77503090	38,5	1

» Şeker Termometresi  
Sugar Thermometer

Kod Code	Koli/Adet Pcs/Ctn
62060003	1

» Pürmüz  
Torch

Kod Code	Koli/Adet Pcs/Ctn
43030048	1



» Derin Kaçarola  
Deep Sauce Pan

Kod Code	Øxh (cm) Øxh (cm)	Lt Lt	Koli/Adet Pcs/Ctn
30150008	16x11	2,2	6
30150004	18x12	3,1	4
30150005	20x13	4,1	4
30150019	22x14	5,3	2
30150006	24x15	6,8	2
30150020	28x17	10,5	2
30150021	30x12	8,5	2
30150030	32x15	12,1	2

» Siğ Kaçarola  
Shallow Sauce Pan

Kod Code	Øxh (cm) Øxh (cm)	Lt Lt	Koli/Adet Pcs/Ctn
30150007	12x6	0,7	6
30150010	14x7	1,1	6
30150015	16x7	1,4	6
30150018	18x8	2,0	4
30150017	20x9	2,8	4
30150016	22x9,5	3,6	2
30150014	24x10,5	4,7	2

\*Ø28, Ø30, Ø32 Destek sap ilavedir

\*Ø28, Ø30, Ø32 w/helper Handle



» Fırın Eldiveni  
Oven Glove

Kod Code	Ölçü (cm) Dim. (cm)	Koli/Adet Pcs/Ctn
43130005	30	4
43130006	40	4

» Deri Eldiven  
Leather Glove (Over Wrist)

Kod Code	Koli/Adet Pcs/Ctn
43030005	4

» Silikon Eldiven Uzun **silikowart**  
Silicone Glove

Kod Code	Koli/Adet Pcs/Ctn
43030004	4

\* Ürün tekli satılmaktadır  
\*Product sold individually



» Sos/Şurup Dökücü

Poring Container

Kod Code	Lt Lt	Koli/Adet Pcs/Ctn
60020001	1	4
60020002	2	4



» BO Şurupluk

BO

Kod Code	ml ml	Koli/Adet Pcs/Ctn
43030075	500	6
43030076	1000	6

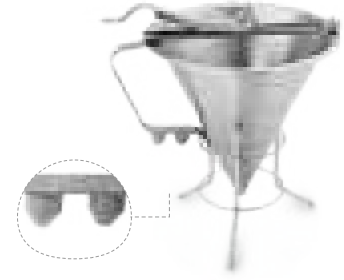

» Sos Hunisi

Sauce Gun

Kod Code	Koli/Adet Pcs/Ctn
62010019	1



» Ölçülü Maşrapa

Calibrated Bain-Marie Pot

Kod Code	Øxh (cm) Øxh (cm)	Koli/Adet Pcs/Ctn
35701416	14x16	2
35701618	16x18	2
35701820	18x20	2
35702022	20x22	2



» Polikarbonat Ölçme Kabı

PC Measuring Cup

Kod Code	Lt Lt	Koli/Adet Pcs/Ctn
60021001	1	6
60021002	2	6
60021003	3	4



» Polipropilen Ölçme Kabı

PC Measuring Cup

Kod Code	Lt Lt	Koli/Adet Pcs/Ctn
43031001	0,5	6
43031002	1	6
43031003	2	6
43031004	3	4
43031006	5	4



» Ölçü Kabı

Measuring Cup

Kod Code	Lt Lt	Koli/Adet Pcs/Ctn
62010001	1	6
62010002	2	6



» Dörtlü Ölçek Seti

Measuring Cup Set

Kod Code	Koli/Adet Pcs/Ctn
40010058	6
*1/4 - 1/3 - 1/2 - 1/1 Cup	



» Dörtlü Ölçü Kaşık Seti

Measuring Spoon Set

Kod Code	Koli/Adet Pcs/Ctn
40010059	6
*2,5 cc - 5 cc - 7,5 cc - 15 cc	

- Regülatör, hız ve dönüş yönünü değiştirmeye izin verir
- LED'ler dönüş yönünü ve hızını gösterir
- Pratik kaymaz silikon mat, işlem sırasında stabilite sağlar
- *The regulator allows to vary speed and direction of rotation*
- *LEDs indicate direction and speed of rotation*
- *The practical non-slip silicone mat ensures greater stability during processing*



» Elektrikli Döner Pasta Standı  
Electrical Cake Turntable

Kod Code	Ölçü (cm) Dim. (cm)	Koli/Adet Pcs/Ctn
77550011	24	1

60 ila 220 mm arasında dereceli tabla  
*Graduated plate between 60 and 220 mm*



LED parlaklığı dönüş hızıyla orantılıdır  
*LED brightness is proportional to the rotation speed*



Saat yönünde ve saat yönünün tersine dönüş  
*Clockwise and anti-clockwise rotation*



Kompakt, pratik ve hafif  
*Compact, practical and light*



116



» Pasta Standı  
Cake Stand

Kod Code	Øxh (cm) Øxh (cm)	Koli/Adet Pcs/Ctn
32502005	20x5	2
32502205	22x5	2
32502405	24x5	2
32503005	30x5	2
32503605	36x5	2
32502210	22x10	2
32502410	24x10	2
32503010	30x10	2
32503610	36x10	2

» Döner Stand Paslanmaz Çelik  
Revolving Cake Stand (S/S)

Kod Code	Øxh (cm) Øxh (cm)	Koli/Adet Pcs/Ctn
43031005	33	1

» Döner Stand  
Revolving Cake Stand

Kod Code	Øxh (cm) Øxh (cm)	Koli/Adet Pcs/Ctn
43030074	33	1



» Alüminyum Baklava Tepsileri  
Aluminum Confectionary Trays

Kod Code	Ölçü (cm) Dim. (cm)	Koli/Ad. Pcs/Ctn
43013040	30x40x4	6
43013345	33x45x4	6
43013545	35x45x4	6
43013547	35x47x4	6
43013851	38x51x4	4
43014050	40x50x4	4
43014060	40x60x4	4
43014061	40x60x1,5	4
43014062	40x60x2	4
43013480	34x80x2	4
43013484	34x84x2	4
43013488	34x88x2	4
43013080	30x80x5	2
43023488	34x88x5	2



» Kırılmaz Tepsisi  
Cake stand

Kod Code	Ölçü (cm) Dim. (cm)	Koli/Ad. Pcs/Ctn
<b>430</b> 30030	10x30	100
<b>430</b> 31530	15x30	50
<b>430</b> 32030	20x30	50
<b>430</b> 32540	25x40	50

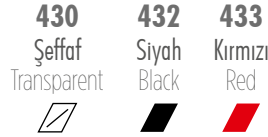

» Pasta / Kek Fanusu  
Cake stand

Kod Code	Ölçü (cm) Dim. (cm)	Model Model	Koli/Adet Pcs/Ctn
80010005	30,5x30,5x11,5	Yuvarlak Round	1
80010007	39x16,5x12,5	Baton Rectangular	1



» Silikon Spatula  
Silicone Spatula

Kod Code	Ölçü (cm) Dim. (cm)	Koli/Adet Pcs/Ctn
52030555	27	6
52030777	38	6
52030007	43	6

**NEW**



» Isıya Dayanıklı Spatula  
Heat-Resistant Spatula

Kod Code	Ölçü (cm) Dim. (cm)	Koli/Adet Pcs/Ctn
77503025	25	6
77503030	30	6
77503035	35	4
77503040	40	4
77503045	45	2



» Silikon Kaşık Spatula  
Silicone Spoon Spatula

Kod Code	Ölçü (cm) Dim. (cm)	Koli/Adet Pcs/Ctn
62022500	27	4
62023500	38	4
62024500	43	4

**NEW**

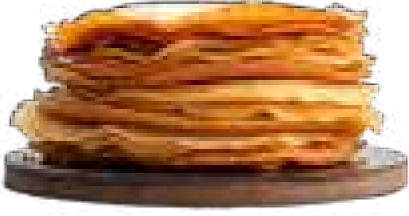

» Pancake Turner  
Pancake Turner

Kod Code	Ölçü (cm) Dim. (cm)	Koli/Adet Pcs/Ctn
83100046	16,5x19	2

NEW



» Pişirme Çatalı  
Carving Fork

Kod Code	Ölçü (cm) Dim. (cm)	Koli/Adet Pcs/Ctn
83100045	20	2

NEW



» Pasta Spatula  
Pastry Spatula

Kod Code	Ölçü (cm) Dim. (cm)	Koli/Adet Pcs/Ctn
62013025	25	4
62013030	30	4
62013035	35	2



» Belli Pasta Spatula  
Angular Spatula

Kod Code	Ölçü (cm) Dim. (cm)	Koli/Adet Pcs/Ctn
62010025	25	4



» Spatula  
Spatula

Kod Code	Ölçü (cm) Dim. (cm)	Koli/Adet Pcs/Ctn
62010010	10	4
62010013	13	4
62010015	15	4



» Geniş Spatula  
Wide Spatula

Kod Code	Ölçü (cm) Dim. (cm)	Koli/Adet Pcs/Ctn
62012020	20	4
62011025	25	4



» Geniş Spatula Delikli  
Perforated Wide Spatula

Kod Code	Ölçü (cm) Dim. (cm)	Koli/Adet Pcs/Ctn
62012025	25	4



» Ayarlı Rulet Çift Taraflı  
Dough Wheel Multi Cut

Kod Code	Model Model	Koli/Adet Pcs/Ctn
43030049	5'li 5 Wheels	1



» Ayarlı Rulet Çift Taraflı  
Dough Wheel Multi Cut

Kod Code	Model Model	Koli/Adet Pcs/Ctn
43030050	7'li 7 Wheels	1



» Pizza Ruleti  
Pizza Roulette

Kod Code	Ölçü (cm) Dim. (cm)	Koli/Adet Pcs/Ctn
62010021	10	6



» Pizza Küreği  
Pizza Spatula

Kod Code	Ölçü (cm) Dim. (cm)	Model Model	Koli/Adet Pcs/Ctn
62010008	17	Normal Plain	4
62010014	17	Delikli Perforated	4



» Pizza Turner  
Pizza Turner

Kod Code	Ölçü (cm) Dim. (cm)	Koli/Adet Pcs/Ctn
83100047	25,5	2
83100048	30,5	2

**NEW**

119



» Servis Spatula (Paslanmaz)  
Serving Spatula (S/S)

Kod Code	Ölçü (cm) Dim. (cm)	Koli/Adet Pcs/Ctn
62010011	25	6





**Servis/Serving**



» Maun Dikdörtgen Tepsi  
Wooden Rectangular Tray

Kod Code	Ölçü (cm) Dim. (cm)	Koli/Adet Pcs/Ctn
68012738	27x38	5
68013244	32x44	5
68013646	36x46	5
68013753	37x53	5
68014361	43x61	5



» Kırçılı Tepsi  
Textured Tray

plast|port®  
by KAPP

Kod Code	Ölçü (cm) Dim. (cm)	Koli/Adet Pcs/Ctn
46612736	27x36	20
46613244	32x44	20
46613646	36x46	20
46613748	37x48	20
46613753	37x53	20



» Fiber Kaydırmaz Yuvarlak Tepsi  
Fiber Non-slip Round Tray

Kod Code	Ø (cm) Ø (cm)	Koli/Adet Pcs/Ctn
68210035	35,5	5
68210040	40,6	5
68210045	45	5

» Maun Kaydırmaz Yuvarlak Tepsi  
Wooden Non-slip Round Tray

Kod Code	Ø (cm) Ø (cm)	Koli/Adet Pcs/Ctn
68110033	33	10
68110038	38	10
68110043	43	10

» Maun Yuvarlak Tepsi  
Wooden Round Tray

Kod Code	Ø (cm) Ø (cm)	Koli/Adet Pcs/Ctn
68010033	33	10
68010038	38	5
68010043	43	5



» Fiber Kaydırmaz Dikdörtgen Tepsi  
Fiber Non-slip Rectangular Tray

Kod Code	Ölçü (cm) Dim. (cm)	Koli/Adet Pcs/Ctn
68213040	30x40	5
68213753	37x53	5
68214565	45x65	5
68215668	56x68(0val)	5

» Maun Kaydırmaz Dikdörtgen Tepsi  
Wooden Non-slip Rectangular Tray

Kod Code	Ölçü (cm) Dim. (cm)	Koli/Adet Pcs/Ctn
68112738	27x38	10
68113244	32x44	25
68113646	36x46	10
68113753	37x53	10
68114361	43x61	15

» Ecoform Kaydırmaz Tepsi  
Ecoform Non-slip Rectangular Tray

Kod Code	Ölçü (cm) Dim. (cm)	Koli/Adet Pcs/Ctn
68413753	37x53	5



» Servis Tepsi (ABS)  
Serving Tray (ABS)

Kod Code	Ölçü (cm) Dim. (cm)	Koli/Adet Pcs/Ctn
<b>460</b> 12736	27x36	20
<b>460</b> 13244	32x44	20
<b>460</b> 13646	36x46	20
<b>460</b> 13748	37x48	20
<b>460</b> 13753	37x53	20



» Servis Tepsi (ABS)  
Serving Tray (ABS)

Kod Code	Ölçü (cm) Dim. (cm)	Koli/Adet Pcs/Ctn
<b>461</b> 12736	27x36	20
<b>461</b> 13244	32x44	20
<b>461</b> 13646	36x46	20
<b>461</b> 13748	37x48	20
<b>461</b> 13753	37x53	20



» Servis Tepsi (ABS)  
Serving Tray (ABS)

Kod Code	Ölçü (cm) Dim. (cm)	Koli/Adet Pcs/Ctn
<b>462</b> 12736	27x36	20
<b>462</b> 13244	32x44	20
<b>462</b> 13646	36x46	20
<b>462</b> 13748	37x48	20
<b>462</b> 13753	37x53	20



» Servis Tepsi (ABS)  
Serving Tray (ABS)

Kod Code	Ölçü (cm) Dim. (cm)	Koli/Adet Pcs/Ctn
<b>463</b> 12736	27x36	20
<b>463</b> 13244	32x44	20
<b>463</b> 13646	36x46	20
<b>463</b> 13748	37x48	20
<b>463</b> 13753	37x53	20



» Servis Tepsi (ABS)  
Serving Tray (ABS)

Kod Code	Ölçü (cm) Dim. (cm)	Koli/Adet Pcs/Ctn
<b>464</b> 12736	27x36	20
<b>464</b> 13244	32x44	20
<b>464</b> 13646	36x46	20
<b>464</b> 13748	37x48	20
<b>464</b> 13753	37x53	20



» Servis Tepsi (ABS)  
Serving Tray (ABS)

Kod Code	Ölçü (cm) Dim. (cm)	Koli/Adet Pcs/Ctn
<b>465</b> 12736	27x36	20
<b>465</b> 13244	32x44	20
<b>465</b> 13646	36x46	20
<b>465</b> 13748	37x48	20
<b>465</b> 13753	37x53	20

## Tepsiler / Trays



### » 1/1 GN Tepsi 1/1 GN Tray

Kod Code	Ölçü (mm) Dim. (mm)	lt lt	Koli/Adet Pcs/Ctn
31611010	530x325x10	1,25	6
31611020	530x325x20	2,5	6
31611040	530x326x40	5	6

### » 2/3 GN Tepsi 2/3 GN Tray

Kod Code	Ölçü (mm) Dim. (mm)	lt lt	Koli/Adet Pcs/Ctn
31623010	354x325x10	0,75	6
31623020	354x325x20	1,5	6
31623040	354x325x40	3	6

### » 1/2 GN Tepsi 1/2 GN Tray

Kod Code	Ölçü (mm) Dim. (mm)	lt lt	Koli/Adet Pcs/Ctn
31612010	325x265x10	0,5	6
31612020	325x265x20	1,25	6
31612040	325x265x40	2,5	6



### » Banket Tepsi Kenar Desenli Figured Tray for Open Buffet

Kod Code	Ölçü (mm) Dim. (mm)	Koli/Adet Pcs/Ctn
31611005	530x325	6



### » Self Servis Standard Self Service

Kod Code	Ölçü (mm) Dim. (mm)	Kalınlık Thickness	Koli/Adet Pcs/Ctn
35040050	28x40x2,5	0,50 mm	25
35040060	28x40x2,5	0,60 mm	25
35040070	28x40x2,5	0,70 mm	25
35040080	28x40x2,5	0,80 mm	25
35040100	28x40x2,5	1,00 mm	25



### » Bölmeli Self Servis Partitioned Self Service

Kod Code	Ölçü (cm) Dim. (cm)	Model Model	Koli/Adet Pcs/Ctn
35820003	12x25,5x1,5	3 Bölmeli 3 Partition	25
35820004	Ø 23x2	5 Bölmeli 5 Partition	25

124



### » Standart Self Servis PC **plast|port** Standart Self Service PC by KAPP

Kod Code	Ölçü (mm) Dim. (mm)	Model Model	Koli/Adet Pcs/Ctn
46010111	398x278x28	Standard	20
46010118	398x278x28	ABS	20



### » Self Servis PC Kriş **plast|port** Self Service PC For Kids by KAPP

Kod Code	Ölçü (mm) Dim. (mm)	Koli/Adet Pcs/Ctn
46010112	360x245x26	20



### » Kahvaltılık Self Servis PC **plast|port** Self Service for Breakfast PC by KAPP

Kod Code	Ölçü (mm) Dim. (mm)	Model Model	Koli/Adet Pcs/Ctn
46010113	290x180x18	Kahvaltılık Breakfast	20
46010114	290x180x18	Yumurtalıklı w/Egg Part	20
46010115	400x280x30	Hindistan Indian	20



» Kaynaklı Kepçe  
Ladle

Kod Code	Ø (cm) Ø (cm)	Kapasite(gr) Capacity (gr)	Koli/Adet Pcs/Ctn
31500001	7,8	75	6
31500002	8,8	100	6
31500003	9,5	145	6
31500004	10,7	220	6
31500005	13,2	456	6
31500016	15,5	661	6
31500007	18	975	6
31500008	20,7	1398	3
31500009	22,5	2150	3
31500010	25	3050	3

» Monoblok Kepçe  
Monoblock Ladle

Kod Code	Ø (cm) Ø (cm)	Kapasite(gr) Capacity (gr)	Koli/Adet Pcs/Ctn
31500065	6,5	63	6
31500080	8	125	6
31500090	9	200	6
31500100	10	250	6
31500120	12	500	6
31500140	14	750	6
31500160	16	1000	6
31500180	18	1250	6
31500200	20	2050	6

» Sos Kepçesi  
Sauce Ladle

Kod Code	Ø (cm) Ø (cm)	Kapasite(gr) Capacity (gr)	Koli/Adet Pcs/Ctn
31503017	5,5	67,5	6
31503018	6,5	70	6
31503019	7	72,5	6
31503020	7,8	75	6

\* Ø 15,5 cm ve üzeri kepçeler desteklidir.  
\* Ø 15,5 cm and above are reinforced

125



» Kaynaklı Kevgir  
Skimmer

Kod Code	Ø (cm) Ø (cm)	Koli/Adet Pcs/Ctn
31600001	9,3	6
31600002	10,4	6
31600003	11,3	6
31600004	12,9	6
31600005	15,1	6
31600016	17,4	6
31600007	19,7	6
31600008	22,2	3
31600009	25,1	3
31600010	28	3

» Monoblok Kevgir  
Monoblock Skimmer

Kod Code	Ø (cm) Ø (cm)	Koli/Adet Pcs/Ctn
31600080	8	6
31600100	10	6
31600120	12	6
31600140	14	6
31600160	16	6
31600180	18	6
31600200	20	6

» Pilav Servis (Kaynaklı)  
Service Spoon

Kod Code	Ø (cm) Ø (cm)	Koli/Adet Pcs/Ctn
31600021	9,3	6
31600022	10,4	6
31600023	11,3	6
31600024	12,9	6
31600025	15,1	6
31600026	17,4	6

\* Ø 15,1 cm ve üzeri kepçeler desteklidir.  
\* Ø 15,1 cm and above are reinforced





» Monoblok Düz Kaşık  
Monoblock Spoon

Kod Code	Uzunluk (cm) L (cm)	Koli/Adet Pcs/Ctn
31601106	27	6
31600104	38	6
31601104	43	6



» Monoblok Süzgeçli Kaşık  
Monoblock Perforated Spoon

Kod Code	Uzunluk (cm) L (cm)	Koli/Adet Pcs/Ctn
31601107	27	6
31600105	38	6
31601105	43	6



» Düz Servis Kaşık  
Serving Spoon

Kod Code	Uzunluk (cm) L (cm)	Koli/Adet Pcs/Ctn
90000009	21	6
90000006	30	6
90000005	43	6



» Süzgeçli Servis Kaşık  
Perforated Serving Spoon

Kod Code	Uzunluk (cm) L (cm)	Koli/Adet Pcs/Ctn
90000010	21	6
90000008	30	6
90000004	43	6



» Et Çatalı (Monoblok)  
Monoblock Meat Fork

Kod Code	Uzunluk (cm) L (cm)	Model Model	Koli/Adet Pcs/Ctn
31602104	50	İkili/2 Prongs	6
31601002	70	İkili/2 Prongs	6
31601003	50	Üçlü/3 Prongs	6
31601004	70	Üçlü/3 Prongs	6



» Servis Çatalı  
Meat Fork for Serving

Kod Code	Uzunluk (cm) L (cm)	Koli/Adet Pcs/Ctn
90000011	21	6
90000007	30	6



» Monoblok Servis Spatula  
Monoblock Spatula

Kod Code	Uzunluk (cm) L (cm)	Koli/Adet Pcs/Ctn
52020021	21	6
52020030	30	6
52020036	36	6



» Monoblok Süzgeçli Servis Spatula  
Monoblock Perforated Spatula

Kod Code	Uzunluk (cm) L (cm)	Koli/Adet Pcs/Ctn
52021021	21	6
52021030	30	6
52021036	36	6



» Servis Spatula  
Serving Spatula

Kod Code	Uzunluk (cm) L (cm)	Koli/Adet Pcs/Ctn
90000015	21	6
90000012	30	6



» Süzgeçli Servis Spatula  
Perforated Serving Spatula

Kod Code	Uzunluk (cm) L (cm)	Koli/Adet Pcs/Ctn
90000014	21	6
90000013	30	6

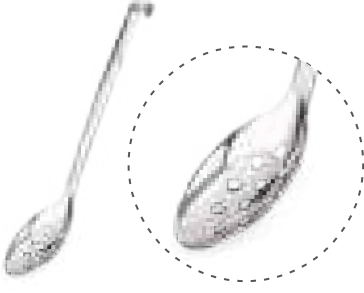

» Delikli Servis Kaşık  
Perforated Spoon

Kod Code	Ölçü (mm) Dim. (mm)	Koli/Adet Pcs/Ctn
52010046	275x53	6

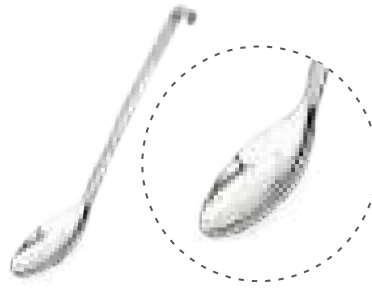

» Servis Kaşığı  
Serving Spoon

Kod Code	Ölçü (mm) Dim. (mm)	Koli/Adet Pcs/Ctn
52010045	275x62	6

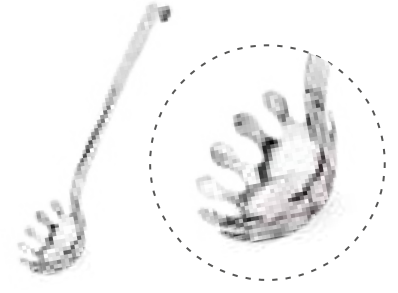

» Spagetti Kaşığı  
Spaghetti Spoon

Kod Code	Ölçü (mm) Dim. (mm)	Koli/Adet Pcs/Ctn
52010058	270x65	6

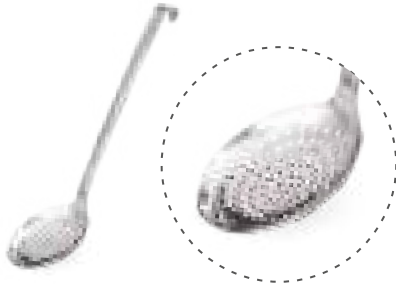

» Kevgir  
Skimmer

Kod Code	Ölçü (mm) Dim. (mm)	Koli/Adet Pcs/Ctn
52010042	270x80	6



» Delikli Spatula  
Perforated Turner

Kod Code	Ölçü (mm) Dim. (mm)	Koli/Adet Pcs/Ctn
52010044	285x75	6



» Çorba Kepçesi  
Ladle

Kod Code	Ölçü (mm) Dim. (mm)	Koli/Adet Pcs/Ctn
52010041	245x60	6

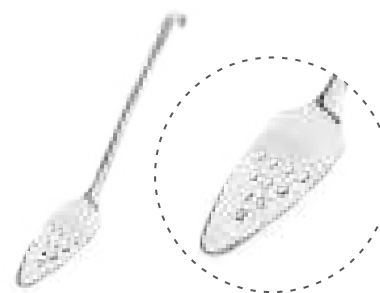

» Delikli Kek Servis  
Perforated Spatula

Kod Code	Ölçü (mm) Dim. (mm)	Koli/Adet Pcs/Ctn
52010049	315x63	6



» PC Servis Kaşığı  
PC Serving Spoon

Kod Code	Model Model	Koli/Adet Pcs/Ctn
46010007	Düz/Plain	50
46010008	Delikli/Perforated	50



» Silikon Kaşık  
Silicone Spoon

Kod Code	Ölçü (mm) Dim. (mm)	Koli/Adet Pcs/Ctn
52030003	330x65	6



» PC Sos Kepçe  
PC Sauce Ladle

Kod Code	Ölçü (cm) Dim. (cm)	Koli/Adet Pcs/Ctn
46010009	20	25
46010015	24	25

» PC Maşa  
PC Tong

Kod Code	Model Model	Koli/Adet Pcs/Ctn
46010018	Makarna Pasta	15
46010021	Servis Serving	15

plast|port<sup>®</sup>  
by KAPP

» Spagetti Maşa  
Pasta Tong

Kod Code	Ölçü (cm) Dim. (cm)	Koli/Adet Pcs/Ctn
36302000	22	6

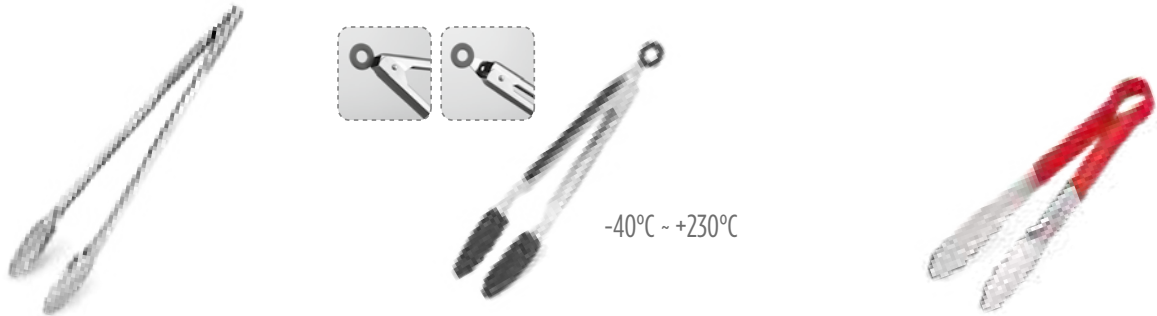

» Çok Amaçlı Maşa  
Multi-Purpose Tong

Kod Code	Ölçü (cm) Dim. (cm)	Koli/Adet Pcs/Ctn
62010030	30	6
62010141	41	6

» Silikon Servis Maşa (Kilitli)  
Silicone Serving Tong

Kod Code	Ölçü (cm) Dim. (cm)	Koli/Adet Pcs/Ctn
40306021	30	6

NEW

» Silikon Saplı Servis Maşa  
Serving Tong w/Silicone Handle

Kod Code	Ölçü (cm) Dim. (cm)	Koli/Adet Pcs/Ctn
40306020	22	6

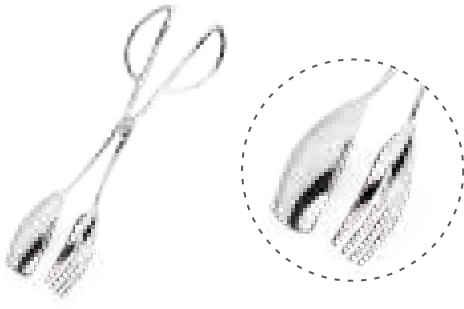

» Makaslı Maşa Salata

Salad Tong

Kod Code	Ölçü (cm) Dim. (cm)	Koli/Adet Pcs/Ctn
52010181	25	6



» Makaslı Maşa Servis

Serving Tong

Kod Code	Ölçü (cm) Dim. (cm)	Koli/Adet Pcs/Ctn
52010189	25	6

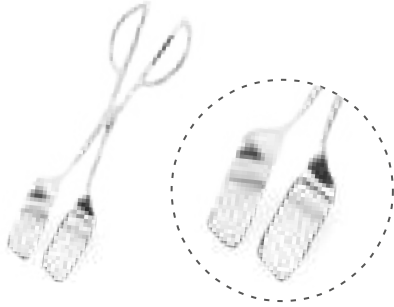

» Makaslı Maşa Ekmek/Pastane

Bread/Pastry Tong

Kod Code	Ölçü (cm) Dim. (cm)	Koli/Adet Pcs/Ctn
52010187	25	6

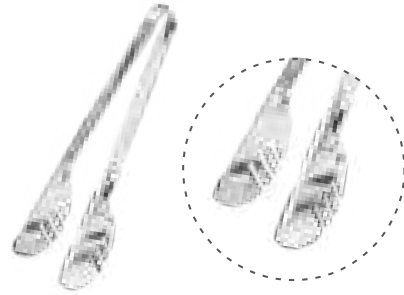

» Çok Amaçlı Maşa

Multi-Purpose Tong

Kod Code	Ölçü (cm) Dim. (cm)	Koli/Adet Pcs/Ctn
52010710	25	6

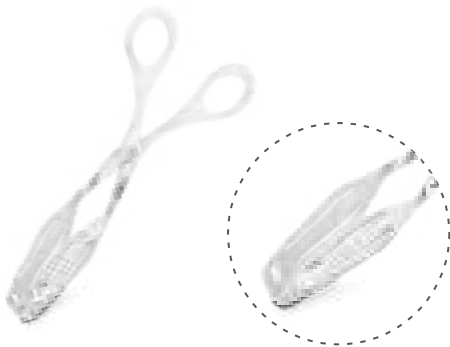

» Makaslı Maşa Ekmek/Pastane Küçük

Bread/Pastry Tong Small

Kod Code	Ölçü (cm) Dim. (cm)	Koli/Adet Pcs/Ctn
52020003	19,5	6

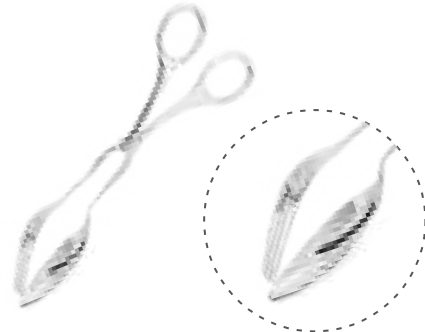

» Makaslı Maşa Salata Küçük

Salad Tong Small

Kod Code	Ölçü (cm) Dim. (cm)	Koli/Adet Pcs/Ctn
52020005	19,5	6



» Salata Maşa  
Salad Tong

Kod Code	Ölçü (cm) Dim. (cm)	Koli/Adet Pcs/Ctn
36310000	22	6



» Şef Cımbızı  
Chef's Tong

Kod Code	Ölçü (mm) Dim. (mm)	Model Model	Koli/Adet Pcs/Ctn
77502913	145x10	Düz/Straight	6
77502021	180x25	Belli/Angular	6
77500025	250	Düz/Straight	6



» Şef Cımbızı Kaşıklı  
Chef's Tong With Tasting Spoon

Kod Code	Ölçü (mm) Dim. (mm)	Koli/Adet Pcs/Ctn
77504030	170x25	1



» Buz Maşa  
Ice Tong

Kod Code	Ölçü (cm) Dim. (cm)	Model Model	Koli/Adet Pcs/Ctn
36303000	16	Classic/Klasik	6
52020004	19	Lüks/Lux	6



» Şeker Maşa  
Sugar Tong

Kod Code	Ölçü (cm) Dim. (cm)	Koli/Adet Pcs/Ctn
36304000	23	1



» Pasta Maşa  
Pastry Tong

Kod Code	Ölçü (cm) Dim. (cm)	Koli/Adet Pcs/Ctn
36311000	21,5	6



» Izgara Maşa  
Grill Tong

Kod Code	Ölçü (cm) Dim. (cm)	Koli/Adet Pcs/Ctn
36306001	25	6
36306002	27,5	6
36306003	32,5	6
36306004	40	6



» Kömür Maşa  
Charcoal Tong

Kod Code	Ölçü (cm) Dim. (cm)	Koli/Adet Pcs/Ctn
36306011	25	6
36306012	27,5	6
36306013	32,5	6
36306014	40	6



» Kılıçık Temizleme Maşası  
Fish Bone Pincer

Kod Code	Ölçü (cm) Dim. (cm)	Koli/Adet Pcs/Ctn
40306022	12	6



» Kaşık Standı  
Spoon Rest

Kod Code	Koli/Adet Pcs/Ctn
52010183	6



» Kepçe Standı  
Spoon/Ladle Rest

Kod Code	Ölçü (cm) Dim. (cm)	Koli/Adet Pcs/Ctn
62010009	9x17	6

\* Fiyata kepçe dahil değildir.  
\* Ladle is not included



» Kepçe/Kaşık Standı  
Spoon/Ladle Rest

Kod Code	Ölçü (cm) Dim (cm)	Koli/Adet Pcs/Ctn
93000011	25x12,5x7,5	1

\* Fiyata kaşık dahil değildir.  
\* Spoon is not included

132



» Dondurma/Ordövr Makası  
Ice Cream Spoon

Kod Code	Ø (mm) Ø (mm)	Koli/Adet Pcs/Ctn
52019039	39	6
52019044	44	6
52019050	50	6
52019056	56	6
52019063	63	6



» Dondurma Kaşığı  
Ice Cream Spoon

Kod Code	Koli/Adet Pcs/Ctn
62010037	6



» Pilav Ölçeği  
Rice Scoop

Kod Code	Ø (mm) Ø (mm)	Kapasite (ml) Capacity (ml)	No No	Koli/Adet Pcs/Ctn
39330001	8	133	1	6
39330002	8,5	148	2	6
39330003	9,5	177	3	6
39330004	10,5	237	4	6
39330005	13,5	473	5	6



» Patates Küreği  
French Fries Shovel

Kod Code	Ölçü (cm) Dim. (cm)	Koli/Adet Pcs/Ctn
62010000	20	2



» Ketchap Dispenseri **plast|port**  
Ketchup Dispenser by KAPP

Kod Code	Lt Lt	Koli/Adet Pcs/Ctn
46010022	2	1



» Mayonenez Dispenseri **plast|port**  
Mayonnaise Dispenser by KAPP

Kod Code	Lt Lt	Koli/Adet Pcs/Ctn
46010023	2	1



» Hardal Dispenseri **plast|port**  
Mustard Dispenser by KAPP

Kod Code	Lt Lt	Koli/Adet Pcs/Ctn
46010025	2	1



» Ketchap Şişesi  
Ketchup Bottle

Kod Code	ml ml	Koli/Adet Pcs/Ctn
43030250	235	6
43030500	355	6
43030750	710	6



» Mayonenez Şişesi  
Mayonnaise Bottle

Kod Code	ml ml	Koli/Adet Pcs/Ctn
43031250	235	6
43031500	355	6
43031750	710	6



» Hardal Şişesi  
Mustard Bottle

Kod Code	ml ml	Koli/Adet Pcs/Ctn
43032250	235	6
43032500	355	6
43032750	710	6



» Seffaf Sos Şişesi  
Transparent Sauce Bottle

Kod Code	ml ml	Koli/Adet Pcs/Ctn
43033250	235	6
43033500	355	6
43033750	710	6



» Sos/Şurup Dökücü  
Pouring Container

Kod Code	ml ml	Koli/Adet Pcs/Ctn
60020001	1	4
60020002	2	4





**Açık Büfe/**Buffet

# TITAN CHAFING DISH



## Patentli Rezistanslı Camlar / Patented Heated Glasses



- Dünyada bir ilk! Buğu yapmayan rezistanslı camlar sayesinde artık yemekler kapaklar açılmadan da görülebilir. Gıdaların ısısını ve hijyenini bu sayede daha uzun süre muhafaza eder.
- Rezistanslı camlar aynı zamanda su damlalarının toplanıp yemeklere damlamasını önler.
- Ortadan ısınmaya başlayan rezistanslı camlar enerji tasarrufu sağlar.
- Farklı renk ve görünümde paslanmaz çelik aksamlar açık büfelere yepyeni bir tarz katar.
- Temperli cam üzerindeki özel izalasyon sayesinde elektrik ve su buharı arasında kısa devre oluşmasını engeller.
- Özel tasarım hidrolik menteşeler kapağın yavaşça kapanmasına yardımcı olur.
- Farklı renk alternatifleri ile otelinizin tasarımına uyum sağlar.
- Tüm parçalar çıkarılabilir ve makinada yıkanabilir.

- A first in the world! Thanks to the anti-fog resistant glasses, the dishes can now be seen without opening the lids. In this way, the temperature and hygiene of the food can be preserved for a longer period of time.
- Resistance glasses also prevent water droplets from collecting and dripping onto the food.
- Resistive glasses that start to heat from the middle save energy.
- Stainless steel components in different colors and appearances add a brand new style to open buffets.
- Thanks to the special insulation on the tempered glass, short circuit between electricity and water vapor is prevented.
- Specially designed hydraulic hinges help the lid to close slowly.
- It adapts to the design of your hotel with different color alternatives.
- All parts are removable and machine washable

137



90°'ye kadar açılır  
Kapak otomatik olarak sessizce kapanır  
Çıkarılabilir kapak: temizlenmesi ve saklanması kolaydır  
*Opens up to 90°  
Lid falls and closed automatically silently  
Removable cover: easy for cleaning and storage*

Su Geri Dönüş Sistemi  
Buharlaşan su yiyeceklerin üzerine  
değil su haznesine geri akar  
*Water Return System  
Condensation flows back to  
water pan instead of food*

Patentli Hidrolik Mentеше  
Min. 100.000 kez aç-kapa  
*Patented Hydraulic Hinge  
Min. 100.000 times open-close*

Üç katmanlı Çelik Taban  
Hızlı ve eşit ısıtma  
*Three-layer Steel Bottom  
for fast and even heating*



138



1 Patentli rezistanslı camlar  
*Patented heated glasses*

2 Ahşap görünlü, kırmızı ve siyah paslanmaz çelik aksamlar  
*Wood-look, red and black color s/s components*

3 Hidrolik kapak  
*Hydraulic Lid*

4 100 W rezistans gücü  
*100 W resistance power*

# TITAN CHAFING DISH

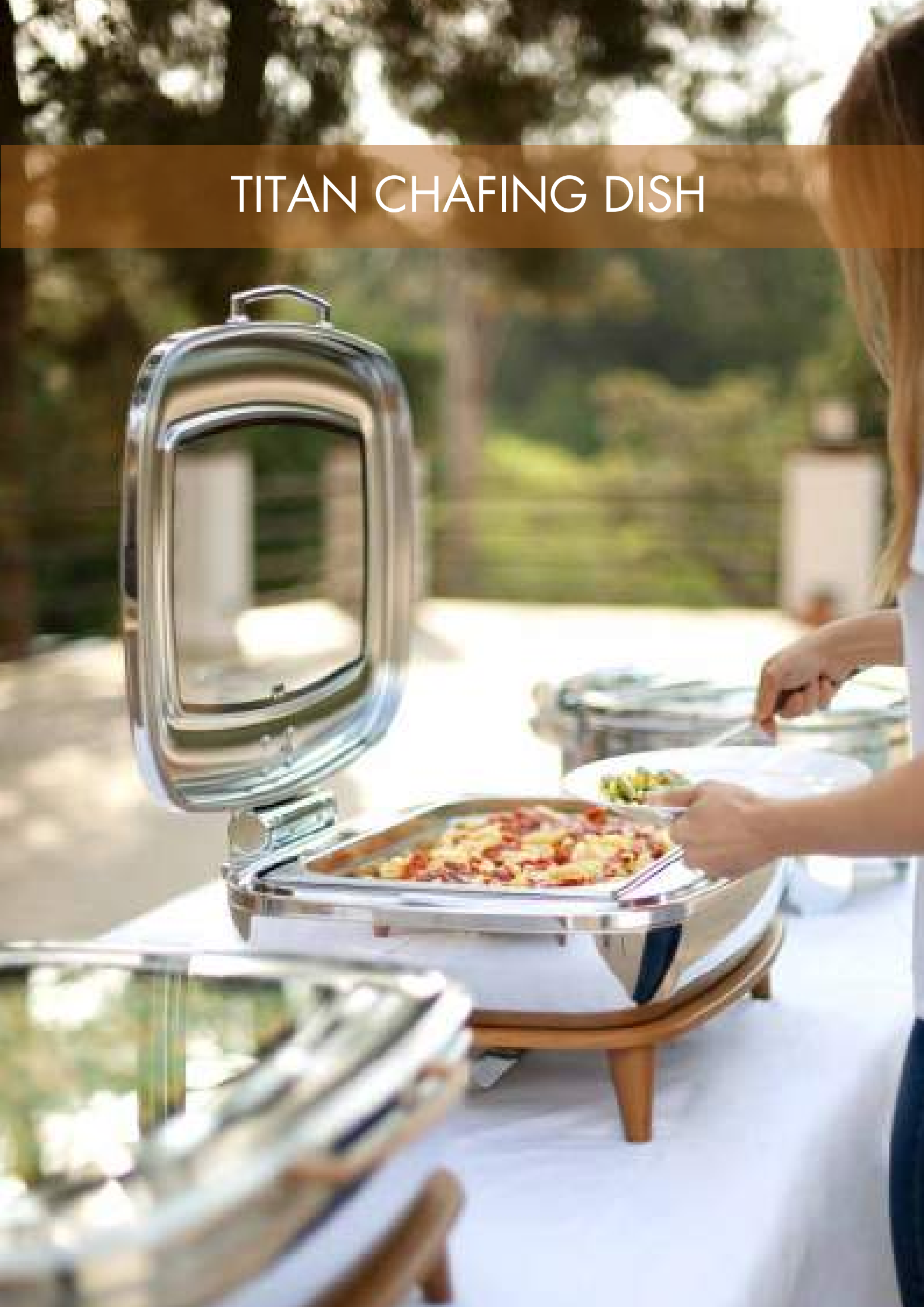

1/1 - 9 L



54010101

İndüksiyon ocaklara uygundur  
Suitable for Induction Plates

» Kod Code	Model Model	Renk Color	Ölçü (cm) Dim. (cm)
57012211	Rezistanslı Kapak/ w/ Heated Lid	Krom / Chrome	64x55,5x16,5
57012011	GN 1/1 - 9 lt.	Krom / Chrome	64x55,5x16,5
54010101	İndüksiyon Isıtıcı 1000W/220V Induction Heating 1000W/220V		

140

57014011



57014012

57015011



57015012

» Kod Code	Model Model	Ölçü (cm) Dim. (cm)
57014211	Kırmızı Rezistanslı Kapak/ w/ Heat Resistant Lid Red	64x55,5x16,5
57014011	GN 1/1 - 9 lt. Kırmızı / Red	64x55,5x16,5
57014012	Ayaklı Stand Kırmızı / Stand Red	63x44,5x11,5
54010101	İndüksiyon Isıtıcı 1000W/220V Induction Heating 1000W/220V	

» Kod Code	Model Model	Ölçü (cm) Dim. (cm)
57015211	Siyah Rezistanslı Kapak/ w/ Heat Resistant Lid Black	64x55,5x16,5
57015011	GN 1/1 - 9 lt. Siyah / Black	64x55,5x16,5
57015012	Ayaklı Stand Siyah / Stand Black	63x44,5x11,5
54010101	İndüksiyon Isıtıcı 1000W/220V Induction Heating 1000W/220V	



» Kod Code	Model Model	Ölçü (cm) Dim. (cm)
57013211	Ahsap Rezistanslı Kapak / w/ Heated Lid Wood	64x55,5x16,5
57013011	GN 1/1 - 9 lt. Ahsap / Wood	64x55,5x16,5
57013012	Ayaklı Stand Ahsap / Stand Wood	63x44,5x11,5



» Kod Code	Model Model	Ölçü (cm) Dim. (cm)
57026148	Bakır Rezistanslı Kapak / w/ Heated Lid Copper	64x55,5x16,5
57016148	GN 1/1 - 9 lt. Bakır / Copper	64x55,5x16,5
57026149	Ayaklı Stand Bakır / Stand Copper	63x44,5x11,5



» Kod Code	Model Model	Ölçü (cm) Dim. (cm)
57026150	Gökkuşığı Rezistanslı Kapak / w/ Heated Lid Rainbow	64x55,5x16,5
57016150	GN 1/1 - 9 lt. Gökkuşığı / Rainbow	64x55,5x16,5
57026151	Ayaklı Stand Gökkuşığı / Stand Rainbow	63x44,5x11,5



» Kod Code	Model Model	Ölçü (cm) Dim. (cm)
57026152	Altın Rezistanslı Kapak / w/ Heated Lid Gold	64x55,5x16,5
57016152	GN 1/1 - 9 lt. Altın / Gold	64x55,5x16,5
57026153	Ayaklı Stand Altın / Stand Gold	63x44,5x11,5



» Kod Code	Model Model	Ölçü (cm) Dim. (cm)
57026154	Füme Rezistanslı Kapak / w/ Heated Lid Smoke	64x55,5x16,5
57016154	GN 1/1 - 9 lt. Gökkuşığı / Smoke	64x55,5x16,5
57026155	Ayaklı Stand Gökkuşığı / Stand Smoke	63x44,5x11,5



» Kod Code	Model Model	Ölçü (cm) Dim. (cm)
57026246	Siyah Rezistanslı Kapak / w/ Heated Lid Black	64x55,5x16,5
57026146	GN 1/1 - 9 lt. Siyah / Black	64x55,5x16,5
57015012	Ayaklı Stand Siyah / Stand Black	63x44,5x11,5

2/3 - 5,5 L

57011032



54010101

İndüksiyon ocaklara uygundur  
Suitable for Induction Plates



142

» Kod Code	Model Model	Renk Color	Ölçü (cm) Dim. (cm)
57011232	Rezistanslı Kapak/ w/ Heated Lid	Krom / Chrome	48,5x54x16,5
57011032	GN 2/3 - 5,5 lt.	Krom / Chrome	48,5x54x16,5
54010101	İndüksiyon Isıtıcı 1000W/220V Induction Heating 1000W/220V		

57014032



57014035

57015032



57015035

» Kod Code	Model Model	Ölçü (cm) Dim. (cm)
57014232	Rezistanslı Kapak Kırmızı/ w/ Heated Lid Red	48,5x54x16,5
57014032	GN 2/3 - 5,5 lt. Kırmızı / Red	48,5x54x16,5
57014035	Ayaklı Stand Kırmızı / Stand Red	47x43x11,5

» Kod Code	Model Model	Ölçü (cm) Dim. (cm)
57015232	Rezistanslı Kapak Siyah/ w/ Heated Lid Black	48,5x54x16,5
57015032	GN 2/3 - 5,5 lt. Siyah / Black	48,5x54x16,5
57015035	Ayaklı Stand Siyah / Stand Black	47x43x11,5



» Kod Code	Model Model	Ölçü (cm) Dim. (cm)
57013232	Rezistanslı Kapak Ahşap / w/ Heated Lid Wood	48,5x54x16,5
57013032	GN 2/3 - 5,5 lt. Ahşap / Wood	48,5x54x16,5
57013035	Ayaklı Stand Ahşap/ Stand Wood	47x43x11,5



» Kod Code	Model Model	Ölçü (cm) Dim. (cm)
57026023	Rezistanslı Kapak Bakır / w/ Heated Lid Copper	48,5x54x16,5
57016023	GN 2/3 - 5,5 lt. Bakır / Copper	48,5x54x16,5
57016035	Ayaklı Stand Bakır / Copper	47x43x11,5



» Kod Code	Model Model	Ölçü (cm) Dim. (cm)
57027023	Rezistanslı Kapak Gökkuşuğu / w/ Heated Lid Rainbow	48,5x54x16,5
57017023	GN 2/3 - 5,5 lt. Gökkuşuğu / Rainbow	48,5x54x16,5
57017035	Ayaklı Stand Gökkuşuğu / Stand Rainbow	47x43x11,5



» Kod Code	Model Model	Ölçü (cm) Dim. (cm)
57012131	Rezistanslı Kapak Altın / w/ Heated Lid Gold	48,5x54x16,5
57012130	GN 2/3 - 5,5 lt. Altın / Gold	48,5x54x16,5
57012240	Ayaklı Stand Altın / Gold	47x43x11,5



» Kod Code	Model Model	Ölçü (cm) Dim. (cm)
57029023	Rezistanslı Kapak Füme / w/ Heated Lid Smoke	48,5x54x16,5
57019023	GN 2/3 - 5,5 lt. Füme / Smoke	48,5x54x16,5
57019035	Ayaklı Stand Füme / Stand Smoke	47x43x11,5



» Kod Code	Model Model	Ölçü (cm) Dim. (cm)
57026147	Rezistanslı Kapak Siyah / w/ Heated Lid Black	48,5x54x16,5
57016147	GN 2/3 - 5,5 lt. Siyah / Black	48,5x54x16,5
57015035	Ayaklı Stand Siyah / Black	47x43x11,5

1/2 - 4 L



54010101

İndüksiyon ocaklara uygundur  
Suitable for Induction Plates



57012150

144

» Kod Code	Model Model	Renk Color	Ölçü (cm) Dim. (cm)
57012151	Rezistanslı Kapak/ w/ Heated Lid	Krom / Chrome	45x40x14
57012150	GN 1/2 - 4 lt.	Krom / Chrome	45x40x14
54010101	İndüksiyon Isıtıcı 1000W/220V Induction Heating 1000W/220V		

57012170



57012270

57012180



57012280

» Kod Code	Model Model	Ölçü (cm) Dim. (cm)
57012171	Rezistanslı Kapak Kırmızı/ w/ Heated Lid Red	45x40x14
57012170	GN 1/2 - 4 lt. Kırmızı / Red	45x40x14
57012270	Ayaklı Stand Kırmızı / Stand Red	43x37x11,5

» Kod Code	Model Model	Ölçü (cm) Dim. (cm)
57012181	Rezistanslı Kapak Siyah/ w/ Heated Lid Black	45x40x14
57012180	GN 1/2 - 4 lt. Siyah / Black	45x40x14
57012280	Ayaklı Stand Siyah / Stand Black	43x37x11,5



NEW



» Kod Code	Model Model	Ölçü (cm) Dim. (cm)
57012161	Rezistanslı Kapak Ahşap/ w/ Heated Lid Wood	45x40x14
57012160	GN 1/2 - 4 lt. Ahşap / Wood	45x40x14
57012260	Ayaklı Stand Ahşap/ Stand Wood	43x37x11,5

» Kod Code	Model Model	Ölçü (cm) Dim. (cm)
57013111	Rezistanslı Kapak Bakır / w/ Heated Lid Copper	45x40x14
57013110	GN 1/2 - 4 lt. Bakır / Copper	45x40x14
57016035	Ayaklı Stand Bakır / Stand Copper	43x37x11,5



NEW



NEW

» Kod Code	Model Model	Ölçü (cm) Dim. (cm)
57012121	Rezistanslı Kapak Gökkuşığı/ w/ Heated Lid Rainbow	45x40x14
57012120	GN 1/2 - 4 lt. Gökkuşığı / Rainbow	45x40x14
57017035	Ayaklı Stand Gökkuşığı / Stand Rainbow	43x37x11,5

» Kod Code	Model Model	Ölçü (cm) Dim. (cm)
57012131	Rezistanslı Kapak Altın / w/ Heated Lid Gold	45x40x14
57012130	GN 1/2 - 4 lt. Altın / Gold	45x40x14
57012240	Ayaklı Stand Altın / Stand Gold	43x37x11,5



NEW



NEW

» Kod Code	Model Model	Ölçü (cm) Dim. (cm)
57012141	Rezistanslı Kapak Füme/ w/ Heated Lid Smoke	45x40x14
57012140	GN 1/2 - 4 lt. Füme / Smoke	45x40x14
57019035	Ayaklı Stand Füme/ Stand Smoke	43x37x11,5

» Kod Code	Model Model	Ölçü (cm) Dim. (cm)
57012191	Rezistanslı Kapak Siyah / w/ Heated Lid Black	45x40x14
57012190	GN 1/2 - 4 lt. Siyah / Black	45x40x14
57012280	Ayaklı Stand Siyah / Stand Black	43x37x11,5

## Titan Chafing Dish 5,7 L

5,7 L

57011060



54010101

İndüksiyon ocaklara uygundur  
Suitable for Induction Plates



146

» Kod Code	Model Model	Renk Color	Ölçü (cm) Dim. (cm)
57011260	Yuvarlak 5,7 Lt. Rezistanslı Kapak/ Round w/ Heated Lid	Krom / Chrome	46x40x19
57011060	Yuvarlak 5,7 Lt. / Round 5,7 Lt	Krom / Chrome	46x40x19
54010101	İndüksiyon Isıtıcı 1000W/220V Induction Heating 1000W/220V		

57014060



57014160

57015060



57015160

» Kod Code	Model Model	Ölçü (cm) Dim. (cm)	» Kod Code	Model Model	Ölçü (cm) Dim. (cm)
57014260	Rezistanslı Kapak Kırmızı/ Round w/ Heated Lid Red	46x40x19	57015260	Rezistanslı Kapak Siyah/ Round w/ Heated Lid Black	46x40x19
57014060	Yuvarlak 5,7 Lt. Kırmızı / Round 5,7 Lt. Red	46x40x19	57015060	Yuvarlak 5,7 Lt. Siyah / Round 5,7 Lt. Black	46x40x19
57014160	Ayaklı Stand Kırmızı / Stand Red	42x42x11,5	57015160	Ayaklı Stand Siyah / Stand Black	42x42x11,5



» Kod Code	Model Model	Ölçü (cm) Dim. (cm)
57013260	Rezistanslı Kapak Ahşap/ Round w/ Heated Lid Wood	46x40x19
57013060	Yuvarlak 5,7 Lt. Ahşap / Round 5,7 Lt. Wood	46x40x19
57013160	Ayaklı Stand Ahşap/ Stand Wood	42x42x11,5



NEW

» Kod Code	Model Model	Ölçü (cm) Dim. (cm)
57022060	Rezistanslı Kapak Bakır / Round w/ Heated Lid Copper	46x40x19
57012060	Yuvarlak 5,7 Lt. Bakır / Round 5,7 Lt. Copper	46x40x19
57011160	Ayaklı Stand Bakır / Stand Copper	42x42x11,5



NEW

» Kod Code	Model Model	Ölçü (cm) Dim. (cm)
57026060	Rezistanslı Kapak Gökkuşaağı/ Round w/ Heated Lid Rainbow	46x40x19
57016060	Yuvarlak 5,7 Lt. Gökkuşaağı / Round 5,7 Lt. Rainbow	46x40x19
57016160	Ayaklı Stand Gökkuşaağı / Stand Rainbow	42x42x11,5



NEW

» Kod Code	Model Model	Ölçü (cm) Dim. (cm)
57027060	Rezistanslı Kapak Altın / Round w/ Heated Lid Gold	46x40x19
57017060	Yuvarlak 5,7 Lt. Altın / Round 5,7 Lt. Gold	46x40x19
57017160	Ayaklı Stand Altın / Stand Gold	42x42x11,5

147



NEW

» Kod Code	Model Model	Ölçü (cm) Dim. (cm)
57028060	Rezistanslı Kapak Füme/ Round w/ Heated Lid Smoke	46x40x19
57018060	Yuvarlak 5,7 Lt. Füme / Round 5,7 Lt. Smoke	46x40x19
57018160	Ayaklı Stand Füme / Stand Smoke	42x42x11,5



NEW

» Kod Code	Model Model	Ölçü (cm) Dim. (cm)
57029060	Rezistanslı Kapak Siyah/ Round w/ Heated Lid Black	46x40x19
57019060	Yuvarlak 5,7 Lt. Siyah / Round 5,7 Lt. Black	46x40x19
57015160	Ayaklı Stand Siyah / Stand Black	42x42x11,5

14,3 L



54010101

İndüksiyon ocaklara uygundur  
Suitable for Induction Plates



57011015

148

» Kod Code	Model Model	Renk Color	Ölçü (cm) Dim. (cm)
57011215	Çorbalık 14,3 Lt. Rezistanslı Kapak/ Soup Station w/ Heated Lid	Krom / Chrome	46x40x25
57011015	Çorbalık 14,3 Lt./ Soup Station 14,3 Lt.	Krom / Chrome	46x40x25
54010101	İndüksiyon Isıtıcı 1000W/220V Induction Heating 1000W/220V		

57014015



57014160

57015015



57015160

» Kod Code	Model Model	Ölçü (cm) Dim. (cm)
57014215	Rezistanslı Kapak Kırmızı/ w/ Heated Lid Red Soup Station	46x40x25
57014015	Çorbalık 14,3 Lt. Kırmızı/ Soup Station 14,3 Lt. Red	46x40x25
57014160	Ayaklı Stand Kırmızı / Stand Red	42x42x11,5

» Kod Code	Model Model	Ölçü (cm) Dim. (cm)
57015215	Rezistanslı Kapak Siyah/ w/ Heated Lid Black Soup Station	46x40x25
57015015	Çorbalık 14,3 Lt. Siyah/Soup Station 14,3 Lt. Black	46x40x25
57015160	Ayaklı Stand Siyah/ Stand Black	42x42x11,5



NEW

» Kod Code	Model Model	Ölçü (cm) Dim. (cm)
57013215	Rezistanslı Kapak Ahşap/ w/ Heated Lid Wood Soup Station	46x40x25
57013015	Çorbalık 14,3 Lt. Ahşap / Soup Station 14,3 Lt. Wood	46x40x25
57013160	Ayaklı Stand Ahşap/ Stand Wood	42x42x11,5

» Kod Code	Model Model	Ölçü (cm) Dim. (cm)
57012215	Rezistanslı Kapak Bakır/ w/ Heated Lid Copper Soup Station	46x40x25
57012015	Çorbalık 14,3 Lt. Bakır / Soup Station 14,3 Lt. Copper	46x40x25
57011160	Ayaklı Stand Bakır/ Stand Copper	42x42x11,5



NEW

» Kod Code	Model Model	Ölçü (cm) Dim. (cm)
57016215	Rezistanslı Kapak Gökkuşığı/ w/ Heated Lid Rainbow Soup Station	46x40x25
57016015	Çorbalık 14,3 Lt. Gökkuşığı / Soup Station 14,3 Lt. Rainbow	46x40x25
57016160	Ayaklı Stand Gökkuşığı / Stand Rainbow	42x42x11,5



NEW

» Kod Code	Model Model	Ölçü (cm) Dim. (cm)
57017215	Rezistanslı Kapak Altın/ w/ Heated Lid Gold Soup Station	46x40x25
57017015	Çorbalık 14,3 Lt. Altın / Soup Station 14,3 Lt. Gold	46x40x25
57017160	Ayaklı Stand Altın Stand Gold	42x42x11,5

149



NEW

» Kod Code	Model Model	Ölçü (cm) Dim. (cm)
57018215	Rezistanslı Kapak Füme/ w/ Heated Lid Smoke Soup Station	46x40x25
57018015	Çorbalık 14,3 Lt. Füme / Soup Station 14,3 Lt. Smoke	46x40x25
57018160	Ayaklı Stand Füme/ Stand Smoke	42x42x11,5



NEW

» Kod Code	Model Model	Ölçü (cm) Dim. (cm)
57019215	Rezistanslı Kapak Siyah/ w/ Heated Lid Black Soup Station	46x40x25
57019015	Çorbalık 14,3 Lt. Siyah / Soup Station 14,3 Lt. Black	46x40x25
57015160	Ayaklı Stand Siyah / Stand Black	42x42x11,5

# VEGA CHAFING DISH



- 1 Kendinden 500 W Elektrikli Isıtıcı  
*Self Electrical Heating 500 W*
- 2 Su Geçirmez Kontrol  
*Waterproof Switch*
- 3 90° de sabitlenebilir kapak  
*Stable at 90°*
- 4 Çıkarılabilir Elektrik Kablosu  
*Removable power cord*
- 5 Silikon Koruyucu  
*Silicone Protector Pad*

Çıkarılabilir Kapak  
Removable Cover

Geniş Cam Kapak  
Full Glass Window

Hidrolik Kapak  
Hydraulic Lid





54010101

İndüksiyon ocaklara uygundur  
*Suitable for Induction Plates*

152

» Kod Code	Model Model	Ölçü (cm) Dim. (cm)
56012011	GN 1/1 - 9 lt.	63x46x17
54010101	İndüksiyon Isıtıcı 1000W/220V <i>Induction Heating 1000W/220V</i>	

Kendinden 500 W Elektrikli Isıtıcı  
*Self Electrical Heating System 500 W*



Hidrolik Kapak  
*Hydraulic Lid*



Su Geçirmez Kontrol  
*Waterproof Switch*



Çıkarılabilir Elektrik Kablosu  
*Removable power cord*



Hidrolik Kapak  
*Hydraulic Lid*





54010101

İndüksiyon ocaklara uygundur  
Suitable for Induction Plates

> Kod Code	Model Model	Ölçü (cm) Dim. (cm)
56012032	GN 2/3 - 6 lt.	48x46x17
54010101	İndüksiyon Isıtıcı 1000W/220V Induction Heating 1000W/220V	

153

Kendinden 500 W Elektrikli Isıtıcı  
Self Electrical Heating System 500 W



Hidrolik Kapak  
Hydraulic Lid

Su Geçirmez Kontrol  
Waterproof Switch



Çıkarılabilir Elektrik Kablosu  
Removable power cord



Hidrolik Kapak  
Hydraulic Lid





54010101

İndüksiyon ocaklara uygundur  
Suitable for Induction Plates



154

> Kod Code	Model Model	Ölçü (cm) Dim. (cm)
56012060	Yuvarlak - 6 lt. / Round - 6 lt	50x50x17
54010101	İndüksiyon Isıtıcı 1000W/220V Induction Heating 1000W/220V	

Kendinden 500 W Elektrikli Isıtıcı  
Self Electrical Heating System 500 W



Hidrolik Kapak  
Hydraulic Lid

Su Geçirmez Kontrol  
Waterproof Switch



Çıkarılabilir Elektrik Kablosu  
Removable power cord



Hidrolik Kapak  
Hydraulic Lid





54010101

İndüksiyon ocaklara uygundur  
Suitable for Induction Plates

> Kod Code	Model Model	Ölçü (cm) Dim. (cm)
56012015	Çorbalık - 11 lt. / Soup Station- 11 lt	40x40x28,5
54010101	İndüksiyon Isıtıcı 1000W/220V Induction Heating 1000W/220V	

155

Kendinden 500 W Elektrikli Isıtıcı  
Self Electrical Heating System 500 W



Hidrolik Kapak  
Hydraulic Lid

Su Geçirmez Kontrol  
Waterproof Switch



Çıkarılabilir Elektrik Kablosu  
Removable power cord



Hidrolik Kapak  
Hydraulic Lid

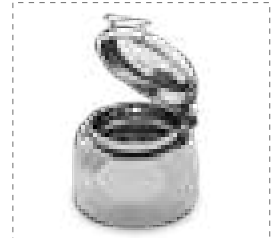

# CARINA CHAFING DISH



90 ° de Sabitlenebilir Kapak

Kapak yavaşça ve sessizce otomatik olarak kapanır  
Çıkarılabilir kapak kolay temizlik ve depolama sağlar

*Opens up to 90 °*

*Lid falls and closed automatically silently*

*Removable cover: easy for cleaning and storage*

Buhar Toplama Sistemi  
Buhardan oluşan su damlaları  
su kabına geri akar yemeğin  
üzerine akmaz

*Water Return System  
Condensation flows back to  
water pan instead of food*

Patentli Hidrolik Mentеше  
Min. 100.000 açma-kapama

*Patented Hydraulic Hinge  
Min. 100.000 times open-close*

3 Kat Çelik Taban  
Hızlı ve eşit pişirme için

*Three-layer Steel Bottom  
for fast and even heating*

Hidrolik Kapak  
Hydraulic Lid



55012011

55013011

158



54010101

İndüksiyon ocaklara uygundur  
Suitable for Induction Plates

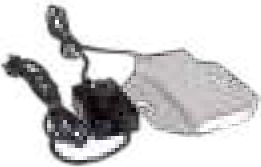

54010500

9 Kademeli 500 W Termostatlı Isıtıcı ile uyumludur  
Suitable for 500 W Electrical Heating Unit w/9 Temperature Control

Kod Code	Model Model	Ölçü (cm) Dim. (cm)
55012011	GN 1/1 - 11,2 lt.	58x47,5x17
55013011	GN 1/1 Ayaklı Stand/ Stand	61,5x40x17,5
54010101	İndüksiyon Isıtıcı 1000W/220V Induction Heating 1000W/220V	



55013011

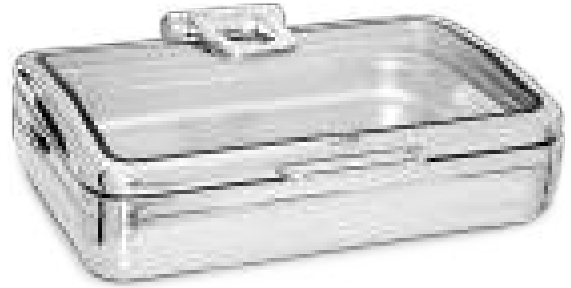

55012011

Hidrolik Kapak  
Hydraulic Lid



54010101

İndüksiyon ocaklara uygundur  
Suitable for Induction Plates



55012032

55012035

159

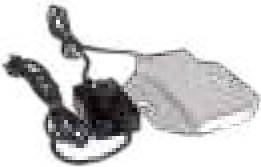

54010500

9 Kademeli 500 W Termostatlı Isıtıcı ile uyumludur  
Suitable for 500 W Electrical Heating Unit w/9 Temperature Control

» Kod Code	Model Model	Ölçü (cm) Dim. (cm)
55012032	GN 2/3 - 5,5 lt.	47,5x41x17
55012035	GN 2/3 Ayaklı Stand/ Stand	43,5x40x17,5
54010101	İndüksiyon Isıtıcı 1000W/220V Induction Heating 1000W/220V	



55012035



55012032

Hidrolik Kapak  
Hydraulic Lid



55012060



54010101

İndüksiyon ocaklara uygundur  
Suitable for Induction Plates

55012065

160



54010500

9 Kademeli 500 W Termostatlı Isıtıcı ile uyumludur  
Suitable for 500 W Electrical Heating Unit w/9 Temperature Control

> Kod Code	Model Model	Ölçü (cm) Dim. (cm)
55012060	Yuvarlak 5,7 Lt. / Round 5,7 Lt	53,5x45,5x17
55012065	Yuvarlak Ayaklı Stand / Round Stand	44,5x44,5x17,5
54010101	İndüksiyon Isıtıcı 1000W/220V Induction Heating 1000W/220V	



55012065



55012060

Hidrolik Kapak  
Hydraulic Lid



54010101

İndüksiyon ocaklara uygundur  
Suitable for Induction Plates



55012015

55012018

161



54010500

9 Kademeli 500 W Termostatlı Isıtıcı ile uyumludur  
Suitable for 500 W Electrical Heating Unit w/9 Temperature Control

Kod Code	Model Model	Ölçü (cm) Dim. (cm)
55012015	Çorbalık 14,3 Lt./ Soup Station 14,3 Lt.	47,5x43,5x26,5
55012018	Çorbalık Ayaklı Stand/ Soup Station Stand	37x37x17,5
54010101	İndüksiyon Isıtıcı 1000W/220V Induction Heating 1000W/220V	



55012018



55012015



Kendinden Buz Hazneli Kapak  
*Lid has Self Ice Store*



» Carina İçecek Dispenseri  
Carina Juice Dispenser

Kod	Lt
Code	Lt
55011277	7,7



» Carina İçecek Dispenseri  
Carina Juice Dispenser

Kod	Lt
Code	Lt
55011278	2x7,7



» Carina İçecek Dispenseri  
Carina Juice Dispenser

Kod	Lt
Code	Lt
55011279	3x7,7



» Vega Kahve Dispenseri  
Vega Coffee Dispenser

Kod	Lt
Code	Lt
55011312	12



» Vega İçecek Dispenseri  
Vega Juice Dispenser

Kod	Lt
Code	Lt
55011412	12

163



» Carina Corn Flakes Dispenseri  
Carina Cereal Dispenser

Kod	Lt
Code	Lt
55011231	3,7



» Carina Corn Flakes Dispenseri  
Carina Cereal Dispenser

Kod	Lt
Code	Lt
55011232	2x3,7



» Carina Corn Flakes Dispenseri  
Carina Cereal Dispenser

Kod	Lt
Code	Lt
55011233	3x3,7

# Premium Chafing Dish



Hidrolik Kapak  
Hydraulic Lid



54011011



54011011

İndüksiyon ocaklara uygundur  
Suitable for Induction Plates

54011014

Kod Code	Model Model	Ölçü (cm) Dim. (cm)	Koli/Adet Pcs/Ctn
54011011	GN 1/1 - 9 lt.	59,5x46x23,5	1
54011014	GN 1/1 Ayaklı Stand/ Stand	52x42x17,5	1
54010101	İndüksiyon Isıtıcı 1000W/220V Induction Heating 1000W/220V		1

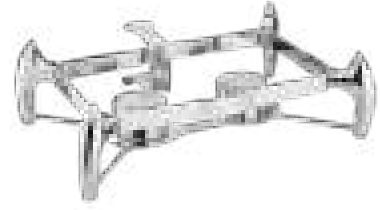

54011014



54010101

165

Hidrolik Kapak  
Hydraulic Lid



54011032



54011032

İndüksiyon ocaklara uygundur  
Suitable for Induction Plates

54011035

Kod Code	Model Model	Ölçü (cm) Dim. (cm)	Koli/Adet Pcs/Ctn
54011032	GN 2/3 - 6 lt.	46x42x22,5	1
54011035	GN 2/3 Ayaklı Stand/ Stand	42x38x218	1
54010101	İndüksiyon Isıtıcı 1000W/220V Induction Heating 1000W/220V		1



54011035



54010101

## Premium Chafing Dish

Hidrolik Kapak  
Hydraulic Lid



54011060



54011060

İndüksiyon ocaklara uygundur  
Suitable for Induction Plates

>> Kod Code	Model Model	Ölçü (cm) Dim. (cm)	Koli/Adet Pcs/Ctn
54011060	Yuvarlak 6 Lt. / Round 6 Lt	52,5x46x22,5	1
54011160	Yuvarlak Ayaklı Stand/ Round Stand	43,5x33x18	1
54010101	İndüksiyon Isıtıcı 1000W/220V Induction Heating 1000W/220V		1



54010101



54011160

166

Hidrolik Kapak  
Hydraulic Lid



54011015



54011015

İndüksiyon ocaklara uygundur  
Suitable for Induction Plates

>> Kod Code	Model Model	Ölçü (cm) Dim. (cm)	Koli/Adet Pcs/Ctn
54011015	Çorbalık 11 Lt./ Soup Station 11 Lt.	44x44x33	1
54011018	Çorbalık Ayaklı Stand/ Soup Station Stand	43,5x33x18	1
54010101	İndüksiyon Isıtıcı 1000W/220V Induction Heating 1000W/220V		1



54010101



54011018



» Premium Süt Dispenseri  
Premium Milk Dispenser

Kod Code	(Lt) (Lt)	Koli/Adet Pcs/Ctn
54011212	6	1

» Premium İçecek Dispenseri  
Premium Juice Dispenser

Kod Code	(Lt) (Lt)	Koli/Adet Pcs/Ctn
54011112	12	1

» Premium Kahve Dispenseri  
Premium Coffee Dispenser

Kod Code	(Lt) (Lt)	Koli/Adet Pcs/Ctn
59011019	19	1



» Gömme İndüksiyon ocak  
Built-In Induction Cooker

Kod Code	Ölçü (cm) Dim. (cm)	Güç Power	Koli/Adet Pcs/Ctn
57103838	36x38x12,3	3500 W	1



# Delux Chafing Dish Genel Özellikler

## Delux Chafing Dish Specifications



- 1 90° de sabitlenebilir kapak  
*Stable at 90°*
- 2 180° açılır kapak  
*Stable at 180°*
- 3 Kolay çıkarılabilir, yıkanabilir kapak  
*For quick and easy cleaning*
- 4 9 kademeli termostatlı ısıtıcı  
*Electrical heating unit w/9 Temperature Control*
- 5 Üst üste muhafaza edilebilme özelliği  
*Stackable Design*



» GN 1/1 Roll Top  
GN 1/1 Roll Top

Kod Code	Model Model	Ölçü (cm) Dim. (cm)
54010733	9 lt. Jelli/ w/Burner	73x49x34
54010800	Termostatlı Isıtıcı 700 W/ Electrical Heater 700 W	



» Yuvarlak Roll Top  
Round Roll Top

Kod Code	Model Model	Ölçü (cm) Dim. (cm)
54010731	6 lt. Jelli/w/Burner	53x53x35
54010800	Termostatlı Isıtıcı 700 W/ Electrical Heater 700 W	



**ÖZELLİKLER**

- 90° de sabitlenebilir kapak
- 180° açılır kapak
- Kolay çıkarılabilir, yıkanabilir kapak
- 9 kademeli termostatlı ısıtıcı
- Üst üste muhafaza edilebilme özelliği



» Roll Top Çift Çorbalık  
Roll Top w/Soup Tureens

Kod Code	Model Model	Ölçü (cm) Dim. (cm)
54010738	2x4,5 lt. Jelli/w/Burner	73x49x34
54010800	Termostatlı Isıtıcı 700 W/ Electrical Heater 700 W	



» Roll Top Çorbalık  
Round Roll Top w/Soup Tureens

Kod Code	Model Model	Ölçü (cm) Dim. (cm)
54010730	6 lt. Jelli/w/Burner	53x53x35
54010800	Termostatlı Isıtıcı 700 W/ Electrical Heater 700 W	





» Gmme GN 1/1  
Built-In GN 1/1

Kod Code	Model Model	l (cm) Dim. (cm)
54012733	9 lt. Jelli/ w/Burner	63x46,5x24
54010800	Termostatlı Isıtıcı 700 W/ Electrical Heater 700 W	

#### SPECIFICATIONS

- Stable at 90°
- Stable at 180°
- For quick & easy cleaning
- Electrical heating unit w/9 Temperature Control
- Stackable design

170



» Gmme Yuvarlak  
Built-In Round Shaped

Kod Code	Model Model	l (cm) Dim. (cm)
54012731	6 lt. Jelli/w/Burner	63x48x26
54010800	Termostatlı Isıtıcı 700 W/ Electrical Heater 700 W	



» Gmme orbalık  
Built-In Round Shaped w/Soup Tureen

Kod Code	Model Model	l (cm) Dim. (cm)
54012730	6 lt. Jelli/w/Burner	63x48x26
54010800	Termostatlı Isıtıcı 700 W/ Electrical Heater 700 W	



» GN 1/1 Roll Top  
GN 1/1 Roll Top

Kod Code	Model Model	Ölçü (cm) Dim. (cm)
54010723	9 lt. Jelli/ w/Burner	75x50x33
54010500	Termostatlı Isıtıcı 500 W/ Electrical Heater 500 W	



» Yuvarlak Roll Top  
Roll Top Round Shaped

Kod Code	Model Model	Ölçü (cm) Dim. (cm)
54010721	6 lt. Jelli/w/Burner	53x49,5x35
54010500	Termostatlı Isıtıcı 500 W/ Electrical Heater 500 W	



» Çorbalık Roll Top  
Round Shaped w/Soup Tureen

Kod Code	Model Model	Ölçü (cm) Dim. (cm)
54010720	6 lt. Jelli/w/Burner	53x49,5x35
54010500	Termostatlı Isıtıcı 500 W/ Electrical Heater 500 W	



» Ekonomik GN 1/1  
Economic GN 1/1

Kod Code	Model Model	Ölçü (cm) Dim. (cm)
54010433	9 lt. Jelli 9 lt. w/Burner	60x35x32

\*Termostatlı ısıtıcı ile kullanıma uygun değildir  
\*Not suitable for use with electrical heater



» Mini Chafing Dish  
Mini Chafing Dish

Kod Code	Model Model	Ölçü (cm) Dim. (cm)
40210151	Jelli w/Burner	32x32



» İndüksiyon Isıtıcı  
Induction Heating

Kod Code	Güç Power	Koli/Adet Pcs/Ctn
54010101	1000 W	1



» Yakıt Haznesi  
Burner Holder

Kod Code	Koli/Adet Pcs/Ctn
54010100	2



» 9 Kademeli Termostatlı Isıtıcı  
Electrical Heating Unit w/9 Temperature Control

Kod Code	Güç Power	Koli/Adet Pcs/Ctn
54010500	500 Watt	1



» 9 Kademeli Termostatlı Isıtıcı  
Electrical Heating Unit w/9 Temperature Control

Kod Code	Güç Power	Koli/Adet Pcs/Ctn
54010800	700 Watt	1



» GN 1/1 Porselen  
GN 1/1 Porcelain

Kod Code	Ölçü (mm) Dim. (mm)	Koli/Adet Pcs/Ctn
70020101	530x325	1



» GN 1/2 Porselen  
GN 1/2 Porcelain

Kod Code	Ölçü (mm) Dim. (mm)	Koli/Adet Pcs/Ctn
70020102	325x265	1



» GN 2/3 Porselen  
GN 2/3 Porcelain

Kod Code	Ölçü (mm) Dim. (mm)	Koli/Adet Pcs/Ctn
70020203	354x325	1



» GN 1/3 Porselen  
GN 1/3 Porcelain

Kod Code	Ölçü (mm) Dim. (mm)	Koli/Adet Pcs/Ctn
70020103	325x176	1



» Yuvarlak Porselen  
Round Porcelain

Kod Code	Ölçü (cm) Dim. (cm)	Koli/Adet Pcs/Ctn
70020100	39x6,5	1



» Yuvarlak Bölmeli Porselen  
Round Divided Porcelain

Kod Code	Ölçü (cm) Dim. (cm)	Koli/Adet Pcs/Ctn
70021100	39x6,5	1



» Yuvarlak Tepsi  
Round Tray (S/S)

Kod Code	Ölçü (cm) Dim. (cm)	Lt	Koli/Adet Pcs/Ctn
30703565	35x6,5	6,2	4



» Yuvarlak Bölmeli Tepsi  
Round Divided Tray (S/S)

Kod Code	Ölçü (cm) Dim. (cm)	Koli/Adet Pcs/Ctn
70023100	38,5x38,5x6,5	1



» Kaşık Standı  
Spoon Rest

Kod Code	Ölçü (cm) Dim (cm)	Koli/Adet Pcs/Ctn
52010183		6



» Keççe Standı  
Spoon/Ladle Rest

Kod Code	Ölçü (cm) Dim (cm)	Koli/Adet Pcs/Ctn
62010009	9x17	6

\* Fiyata keççe dahil değildir.  
\* Ladle is not included



» Keççe/Kaşık Standı  
Spoon/Ladle Rest

Kod Code	Ölçü (cm) Dim (cm)	Koli/Adet Pcs/Ctn
93000011	25x12,5x7,5	1

\* Fiyata kaşık dahil değildir.  
\* Spoon is not included

174



» Şeker Dispenseri  
Sugar Dispenser

Kod Code	Ölçü (cm) Dim (cm)	Koli/Adet Pcs/Ctn
93000009	14x10x25	1



» İsimlik  
Name Tag

Kod Code	h(cm) h(cm)	Koli/Adet Pcs/Ctn
62010005	5	12
62011010	10	12
62013020	20	12



» İsimlik Büfe  
Name Tag Buffet

Kod Code	Ölçü (cm) Dim (cm)	Koli/Adet Pcs/Ctn
93000013	34x22,5	1

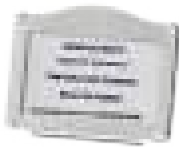

» İsimlik Çerçevesi  
Name Tag Framed

Kod Code	Ölçü (cm) Dim (cm)	Koli/Adet Pcs/Ctn
93000014	34x22,5	1



» İsimlik Standı Çerçevesi  
Name Tag Stand Framed

Kod Code	Ölçü (cm) Dim (cm)	Koli/Adet Pcs/Ctn
93000005	8,5	1



» İsimlik Standı  
Name Tag Stand

Kod Code	Ölçü (cm) Dim (cm)	Koli/Adet Pcs/Ctn
93000004	4	1

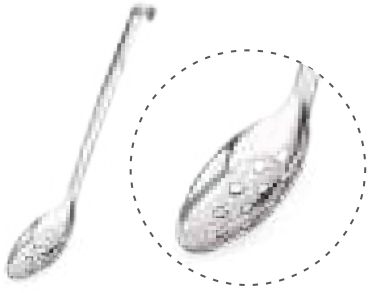

» Delikli Servis Kaşık  
Perforated Spoon

Kod Code	Ölçü (mm) Dim. (mm)	Koli/Adet Pcs/Ctn
52010046	275x53	6

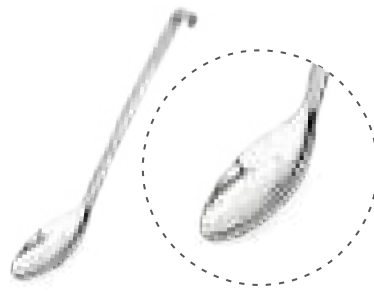

» Servis Kaşığı  
Serving Spoon

Kod Code	Ölçü (mm) Dim. (mm)	Koli/Adet Pcs/Ctn
52010045	275x62	6

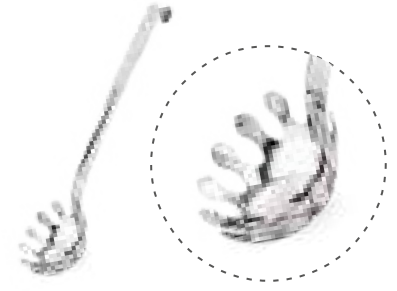

» Spagetti Kaşığı  
Spaghetti Spoon

Kod Code	Ölçü (mm) Dim. (mm)	Koli/Adet Pcs/Ctn
52010058	270x65	6

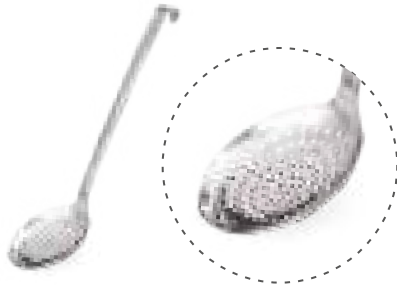

» Kevgir  
Skimmer

Kod Code	Ölçü (mm) Dim. (mm)	Koli/Adet Pcs/Ctn
52010042	270x80	6



» Delikli Spatula  
Perforated Turner

Kod Code	Ölçü (mm) Dim. (mm)	Koli/Adet Pcs/Ctn
52010044	285x75	6



» Çorba Kepçesi  
Ladle

Kod Code	Ölçü (mm) Dim. (mm)	Koli/Adet Pcs/Ctn
52010041	245x60	6

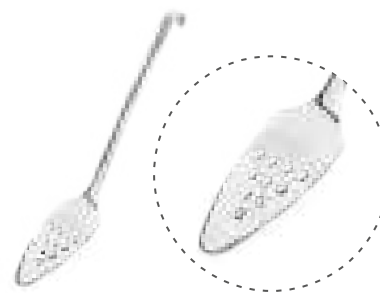

» Delikli Kek Servis  
Perforated Spatula

Kod Code	Ölçü (mm) Dim. (mm)	Koli/Adet Pcs/Ctn
52010049	315x63	6



» Vega İçecek Dispenseri  
Vega Juice Dispenser

Kod Code	Lt Lt	Koli/Adet Pcs/Ctn
55011412	12	1



» Vega Kahve Dispenseri  
Vega Coffee Dispenser

Kod Code	Lt Lt	Koli/Adet Pcs/Ctn
55011312	12	1



» Carina İçecek Dispenseri  
Carina Juice Dispenser

Kod Code	Lt Lt	Koli/Adet Pcs/Ctn
55011277	7,7	1
55011278	2x7,7	1
55011279	3x7,7	1



» Lux İçecek Dispenseri  
Lux Juice Dispenser

Kod Code	Lt Lt	Koli/Adet Pcs/Ctn
54012112	12	1



» Lux Kahve Dispenseri  
Lux Coffee Dispenser

Kod Code	Lt Lt	Koli/Adet Pcs/Ctn
54012212	12	1



» Meyve Suyu Dispenseri  
Juice Dispenser

Kod Code	Ölçü (cm) Dim. (cm)	Lt Lt	Koli/Adet Pcs/Ctn
59039021	37x23x60	7	1
59039022	37x45x69	14	1



» Premium İçecek Dispenseri  
Premium Juice Dispenser

Kod Code	Lt Lt	Koli/Adet Pcs/Ctn
54011112	12	1

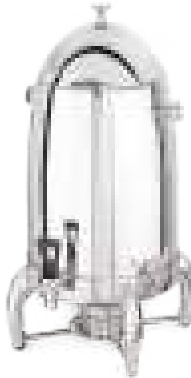

» Premium Kahve Dispenseri  
Premium Coffee Dispenser

Kod Code	Lt Lt	Koli/Adet Pcs/Ctn
59011019	19	1



» Lux Süt Dispenseri  
Lux Milk Can

Kod Code	Lt Lt	Koli/Adet Pcs/Ctn
54011212	6	1

• Kendinden buz hazneli kapak  
• Lid has self ice store



» Carina Corn Flakes Dispenseri  
Carina Corn Flakes Dispenser

Kod Code	Lt Lt	Koli/Adet Pcs/Ctn
55011231	3,7	1
55011232	2x3,7	1
55011233	3x3,7	1



» Corn Flakes Dispenseri  
Corn Flakes Dispenser

Kod Code	Ölçü (cm) Dim. (cm)	Lt Lt	Koli/Adet Pcs/Ctn
54021231	42x23x62	7,5	1
54021232	42x45x62	15	1



» Corn Flakes Dispenseri  
Corn Flakes Dispenser

Kod Code	Model Model	Koli/Adet Pcs/Ctn
40010001	Tekli/Single	1
40010002	2'li/Double	1
40010003	3'li/Triple	1



» Corn Flakes Dispenseri  
Corn Flakes Dispenser

Kod Code	Lt Lt	Koli/Adet Pcs/Ctn
54010010	10	1



- Kumanda anahtarlı açma kapama kontrolü
- Asansörlü ayarlanabilir uzunluk 55-130 cm
- 230 Volt / 1 Ph. / 50 Hz; 250 W
- Hem BOH ( Back of the House) hem de FOH (Front of the House) kullanım için özel tasarım

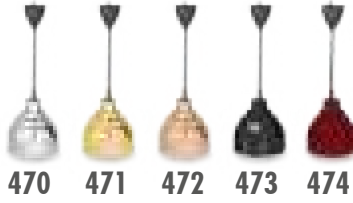

470 471 472 473 474

» Klasik Infrared Lamba  
Classic Infrared Lamp



Kod Code	Renk Colour	Øxh (mm) Øxh (mm)	Koli/Adet Pcs/Ctn
47010006	Krom/Chrome	245x260	1
47110006	Pirinç/Brass	245x260	1
47210006	Bakır/Copper	245x260	1
47310006	Siyah/Black	245x260	1
47410006	Bordo/Maroon	245x260	1

\* Fiyata infrared ampül dahildir.

\* w/infrared bulb



- Adjustable helix cable (55 - 130 cm)
- 230 Volt / 1 Ph. / 50 Hz; 250 W
- Suitable for both BOH ( Back of the House) and FOH (Front of the House) using
- On - Off Switch

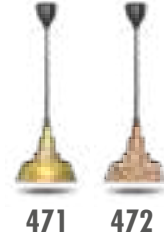

471 472

» Vintage Infrared Lamba  
Vintage Infrared Lamp



Kod Code	Renk Colour	Øxh (mm) Øxh (mm)	Koli/Adet Pcs/Ctn
47610015	Siyah/Black	310x265	1
47110015	Pirinç/Brass	310x265	1
47210015	Bakır/Copper	310x265	1

\* Fiyata infrared ampül dahildir.

\* w/infrared bulb



470 471 472

» Infrared Isıtıcı Tekli Lamba (Ayaklı)  
Self Standing Single Heat Lamp



Kod Code	Ölçü (cm) Dim. (cm)	Güç Power	Koli/Adet Pcs/Ctn
47010003	22x28x70	250 W	1

\* Fiyata infrared ampül dahildir. \* w/infrared bulb



470 471 472

» Infrared Isıtıcı Çiftli Lamba (Ayaklı)  
Self Standing Double Heat Lamp



Kod Code	Ölçü (cm) Dim. (cm)	Güç Power	Koli/Adet Pcs/Ctn
47010004	50x30x70	2x250 W	1

\* Fiyata infrared ampül dahildir. \* w/infrared bulb



» Sıcak Tutucu Isıtıcı Lambalı Set  
Heat Lamp w/Warming Plate



Kod Code	Model Model	Ölçü (cm) Dim. (cm)	Koli/Adet Pcs/Ctn
47013011	1/1	40x60	1

\* Fiyata infrared ampül dahildir. \* w/infrared bulb



» Sıcak Tutucu Isıtıcı Lambalı Set  
Heat Lamp w/Warming Plate



Kod Code	Model Model	Ölçü (cm) Dim. (cm)	Koli/Adet Pcs/Ctn
47013021	2/1	71x59	1

\* Fiyata infrared ampül dahildir. \* w/infrared bulb



» Pasta / Kek Fanusu  
Cake Stand w/Cover



» Katlı Meyvelik Standı  
Fruit Stand



» Pasta Standı  
Cake Stand

180

Kod Code	Model Model	Ölçü (cm) Dim. (cm)	Koli/Adet Pcs/Ctn
80010005	Yuvarlak / Round	30,5x30,5x11,5	6
80010007	Baton / Tangular	39x16,5x12,5	6

Kod Code	Model Model	Ölçü (cm) Dim. (cm)	Koli/Adet Pcs/Ctn
40290001	2 Katlı / 2 Tiered	17	1
40290002	3 Katlı / 3 Tiered	28	1

Kod Code	Øxh (cm) Øxh (cm)	Koli/Adet Pcs/Ctn
32502005	20x5	2
32502205	22x5	2
32502405	24x5	2
32503005	30x5	2
32503605	36x5	2
32502210	22x10	2
32502410	24x10	2
32503010	30x10	2
32503610	36x10	2



» Yay Sunumluk Standı  
Bowl Display Stand

Kod Code	Ölçü (cm) Dim. (cm)	Koli/Adet Pcs/Ctn
40341358	3xStand 46x5	1
40341357	4xStand 57x10,5	1
40341356	5xStand 67x16	1
58020909	Melamin Kase 9x9x5,5 Melamine Square Plate 9x9x5,5	1

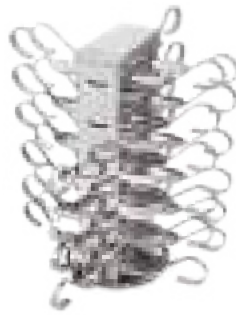

» Sunum Kaşığı Standı  
Amuse Bouche Spoon Stand

Kod Code	Ölçü (cm) Dim. (cm)	Kapasite Capacity	Koli/Adet Pcs/Ctn
40160150	15x34	36 Kaşık/36 Spoons	1
40160151	30x37	60 Kaşık/60 Spoons	1

\* Fiyata sunum kaşıkları dahil değildir.  
\*w/o Amuse Bouche Spoons



» Sunum Kaşığı  
Amuse Bouche Spoon

Kod Code	Ölçü (mm) Dim. (mm)	Koli/Adet Pcs/Ctn
40150500	4,5	12
40150501	6,5	12

\* Fiyatlara yükseltici ayaklar dahil değildir. \* Elevator feet not included in the price.



» Petek Bal Standı  
Honey Comb Stand

Kod Code	Ölçü (cm) Dim. (cm)	Koli/Adet Pcs/Ctn
40340090	23x68x32	1

\* Porselen tabak ve bal kaşığı fiyata dahil değildir.  
\* w/o porcelain plate and honey spoon.



» Yumurta Standı (Isıtmalı)  
Egg Stand w/Heater

Kod Code	Ölçü (cm) Dim. (cm)	Koli/Adet Pcs/Ctn
40200001	26x40x15(24 Gözlü/24 Partition)	1
40200000	32x52x15(32 Gözlü/32 Partition)	1



» Çatal Kaşık Standı  
Cutlery Stand

Kod Code	Ölçü (cm) Dim. (cm)	Koli/Adet Pcs/Ctn
40160231	18x20x23	1
40160232	33x20x23	1
40160233	47x20x23	1

\*Hazne ölçü: Ø 13, Derinlik: 14  
\*Chamber: Ø 13, Depth: 14

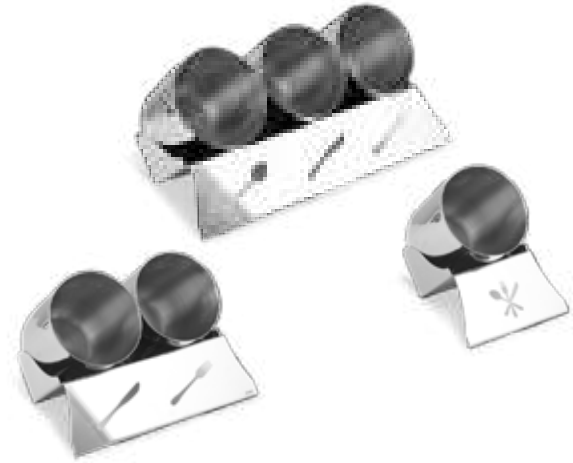

» Çatal Kaşık Standı  
Cutlery Stand

Kod Code	Ölçü (cm) Dim. (cm)	Koli/Adet Pcs/Ctn
40160221	18x20x23	1
40160222	33x20x23	1
40160223	47x20x23	1

\*Hazne ölçü: Ø 13, Derinlik: 14  
\*Chamber: Ø 13, Depth: 14

- Düz, yuvarlak ve dörtgen kaplar için uygundur
- İç içe geçerek muhafaza edilir, yer tasarrufu sağlar
- Katmanlı yerleştirme sistemi üzerine konulan kapların eğik durmasına olanak verir
- Farklı ebatlardaki kaplar tek yükseltici ile kullanılabilir
- Kenetlenme mekanizmasıyla güvenli taşıma sağlar

- Suitable for flat, round and rectangular plates
- Can be intertwined, saves space
- Allows the containers placed on it to stand in a tilted position
- Plates of different sizes can be used with a single riser
- Provides safe transportation with its clamping mechanism



» Kelebek Yükseltici  
Butterfly Elevator

Kod Code	Ölçü (cm) Dim (cm)	Koli/Adet Pcs/Ctn
93000015	24x24x7	1

» Kelebek Yükseltici  
Butterfly Elevator

Kod Code	Ölçü (cm) Dim (cm)	Koli/Adet Pcs/Ctn
93000016	24x24x14	1

» Kelebek Yükseltici  
Butterfly Elevator

Kod Code	Ölçü (cm) Dim (cm)	Koli/Adet Pcs/Ctn
93000017	24x24x21	1

182

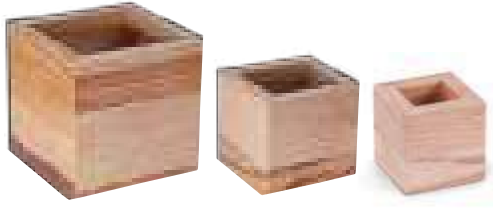

» Küp Ahşap Yükseltici  
Square Wood Riser

Kod Code	Ölçü (cm) Dim. (cm)	Koli/Adet Pcs/Ctn
69011010	10x10x10	1
69011515	15x15x15	1
69012020	20x20x20	1

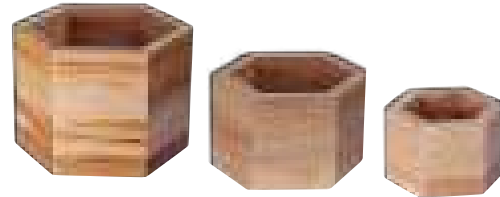

» Altıgen Ahşap Yükseltici  
Sextagon Wood Riser

Kod Code	Ölçü (cm) Dim. (cm)	Koli/Adet Pcs/Ctn
69021414	14x10x10	1
69021919	19,5x10x10	1
69022525	25x10x10	1

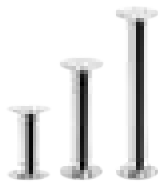

» Yükseltici Ayaklar  
Elevator Feet

Kod Code	Ölçü (cm) Dim. (cm)	Koli/Adet Pcs/Ctn
40100900	6x6	1
40100901	11,5x6	1
40100902	16,5x6	1



» Makas Yükseltici  
Elevator Shears Model

Kod Code	Ölçü (cm) Dim. (cm)	Koli/Adet Pcs/Ctn
40601811	21x21x7	1
40601812	21x21x12	1
40601813	21x21x17	1



» Bazalt Sosluk  
Basalt Sauce Bowl

Kod Code	Ölçü (cm) Dim. (cm)	Model Model	Koli/Adet Pcs/Ctn
78000029	7x4	Tekli/Single	1
78000030	7x4	3'lü Set/Triple Set	1



» Kare Mini Melamin Sunumluk  
Square Mini Melamine Display

Kod Code	Ölçü (mm) Dim (mm)	Kapasite Capacity	Koli/Adet Pcs/Ctn
90013207	115x115x35	207 ml	10



» Kaşık Melamin Sunumluk  
Spoon Melamine Display

Kod Code	Ölçü (mm) Dim (mm)	Kapasite Capacity	Koli/Adet Pcs/Ctn
90013088	190x195	88 ml	16



» Begonia PC Sunumluk  
Begonia PC Display

Kod Code	Kapasite Capacity	Koli/Adet Pcs/Ctn
46010030	30 ml	96
46011060	60 ml	96
460 462 465 466		



» Petunia PC Sosluk/Reçellik  
Petunia PC Sauce Cup

Kod Code	Kapasite Capacity	Koli/Adet Pcs/Ctn
46010040	40 ml	160
46010055	55 ml	160
46020220	220 ml	108
460 461 462 463 464		



» Oval Melamin Sunumluk  
Eliptic Melamine Display

Kod Code	Ölçü (cm) Dim (cm)	Kapasite Capacity	Koli/Adet Pcs/Ctn
90013074	10x6,3	74 ml	72
900 901 902			



» Mini Kaşık Melamin Sunumluk  
Mini Spoon Melamine Display

Kod Code	Ölçü (cm) Dim (cm)	Kapasite Capacity	Koli/Adet Pcs/Ctn
90013015	4,5x15x4,7	15 ml	60
900 901 902			



» İstiridye Melamin Sunumluk  
Oyster Melamine Display

Kod Code	Ölçü (cm) Dim (cm)	Kapasite Capacity	Koli/Adet Pcs/Ctn
90013080	10,5x2,7	80 ml	65
900 901 902			



» Damla Melamin Sunumluk  
Drop Display

Kod Code	Ölçü (cm) Dim (cm)	Kapasite Capacity	Koli/Adet Pcs/Ctn
90013115	5x5,5	115 ml	75
900 901 902			



» Üçgen Melamin Sunumluk  
Triangle Melamine Display

Kod Code	Ölçü (cm) Dim (cm)	Kapasite Capacity	Koli/Adet Pcs/Ctn
90013051	6,5x3	51ml	96
900 901 902			



» Yaprak Melamin Sunumluk  
Leaf Melamine Sunumluk

Kod Code	Ölçü (cm) Dim (cm)	Kapasite Capacity	Koli/Adet Pcs/Ctn
90013018	4,5x11x4	18 ml	48
900 901 902			



» Karo Melamin Sunumluk  
Pillow Melamine Display

Kod Code	Ölçü (cm) Dim (cm)	Kapasite Capacity	Koli/Adet Pcs/Ctn
90013100	11x11x3,6	100 ml	77
900 901 902			



» Oasis Melamin Kase  
Oasis Melamine Bowl

Kod Code	Øxh (cm) Øxh (cm)	Kapasite Capacity	Koli/Adet Pcs/Ctn
92222312	23,3x12,5	1 Lt	6
92222614	26,2x13,8	1,35 Lt	6
92222915	28,5x15,2	1,80 Lt	6



» Oasis Melamin Kase  
Oasis Melamine Bowl

Kod Code	Øxh (cm) Øxh (cm)	Kapasite Capacity	Koli/Adet Pcs/Ctn
90222312	23,3x12,5	1 Lt	6
90222614	26,2x13,8	1,35 Lt	6
90222915	28,5x15,2	1,80 Lt	6



» Olivia Melamin Kase  
Olivia Melamine Bowl

Kod Code	Ölçü (cm) Dim (cm)	Kapasite Capacity	Koli/Adet Pcs/Ctn
90153120	31x20x7,5	1,5 Lt	30
90154027	40x27x7,5	3,1 Lt	20



» Guru Melamin Kase  
Guru Melamine Bowl

Kod Code	Øxh (cm) Øxh (cm)	Kapasite Capacity	Koli/Adet Pcs/Ctn
90282117	21,5x17	2,3	3
90282520	25,5x20	3,7	2



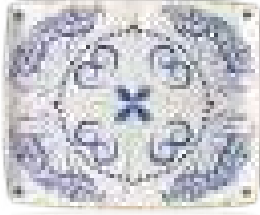

» Athena 1/2 Sunum Tabakası  
Athena 1/2 Display Platter

Kod Code	Ölçü (cm) Dim. (cm)	Koli/Adet Pcs/Ctn
90041012	26,5x32,5x2,5	2



» Athena 1/3 Sunum Tabakası  
Athena 1/3 Display Platter

Kod Code	Ölçü (cm) Dim. (cm)	Koli/Adet Pcs/Ctn
90041013	17,5x32,5x2,2	3

» Athena Dikdörtgen Sunum Tabakası  
Athena Rectangular Display Plate

Kod Code	Ölçü (cm) Dim. (cm)	Koli/Adet Pcs/Ctn
90030027	27,7x19,2x2,8	3
90030034	34,1x23,6x3,3	2



» Athena Yuvarlak Sunum Tabakası  
Athena Round Display Plate

Kod Code	Øxh (cm) Øxh (cm)	Koli/Adet Pcs/Ctn
90043028	28x3,5	3

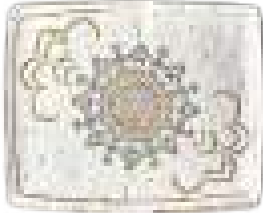

» Casablanca 1/2 Sunum Tabakası  
Casablanca 1/2 Display Platter

Kod Code	Ölçü (cm) Dim. (cm)	Koli/Adet Pcs/Ctn
90041112	26,5x32,5x2,2	2

» Casablanca 1/3 Sunum Tabakası  
Casablanca 1/3 Display Platter

Kod Code	Ölçü (cm) Dim. (cm)	Koli/Adet Pcs/Ctn
90041113	17,6x32,5x2,2	3

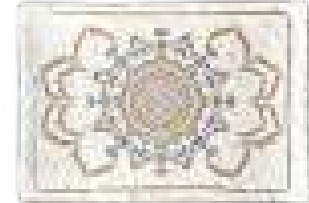

» Casablanca Dikdörtgen Sunum Tabakası  
Casablanca Rectangular Display Plate

Kod Code	Ölçü (cm) Dim. (cm)	Koli/Adet Pcs/Ctn
90030127	27,7x19,2x2,8	3
90030134	34,1x23,6x3,3	2

» Casablanca Yuvarlak Sunum Tabakası  
Casablanca Round Display Plate

Kod Code	Øxh (cm) Øxh (cm)	Koli/Adet Pcs/Ctn
90043128	28x3,5	3





» Genova Sunum Kasesi  
Genova Display Bowl

Kod Code	Øxh (cm) Øxh (cm)	Koli/Adet Pcs/Ctn
90111725	25x7,5	2

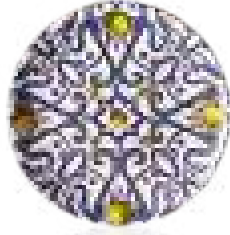

» Genova Sunum Tabağı  
Genova Display Platter

Kod Code	Øxh (cm) Øxh (cm)	Koli/Adet Pcs/Ctn
90111926	26x2,6	3
90111930	30,6x3	3
90111940	40x3,9	1
90111945	45x4,3	1

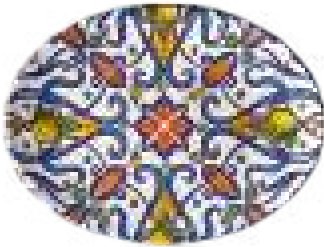

» Genova Oval Sunum Tabağı  
Genova Oval Platter

Kod Code	Ölçü (cm) Dim (cm)	Koli/Adet Pcs/Ctn
90111839	39x29x4,4	2
90111849	49x36,5x4,4	1

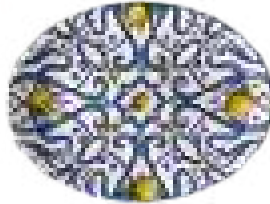

186



» Sevilla Sunum Kasesi  
Sevilla Display Bowl

Kod Code	Øxh (cm) Øxh (cm)	Koli/Adet Pcs/Ctn
90211725	25x7	2



» Sevilla Sunum Tabağı  
Sevilla Display Platter

Kod Code	Øxh (cm) Øxh (cm)	Koli/Adet Pcs/Ctn
90211926	26x2,6	3
90211930	30,6x3	3
90211940	40x3,9	1
90211945	45x4,3	1



» Sevilla Oval Sunum Tabağı  
Sevilla Oval Platter

Kod Code	Ölçü (cm) Dim (cm)	Koli/Adet Pcs/Ctn
90211839	39x29x4,4	2
90211849	49x36,5x4,4	1



» Cordoba Sunum Kasesi  
Cordoba Display Bowl

Kod Code	Øxh (cm) Øxh (cm)	Koli/Adet Pcs/Ctn
90011725	25x7,5	2



» Cordoba Sunum Tabağı  
Cordoba Display Platter

Kod Code	Øxh (cm) Øxh (cm)	Koli/Adet Pcs/Ctn
90011926	26x2,6	3
90011930	30,6x3	3
90011940	40x3,9	1
90011945	45x4,3	1

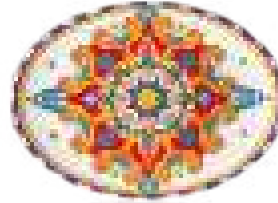

» Cordoba Oval Sunum Tabağı  
Cordoba Oval Platter

Kod Code	Ölçü (cm) Dim (cm)	Koli/Adet Pcs/Ctn
90011839	39x29x4,4	2
90011849	49x36,5x4,4	1

187



» Corona 1/2 Kase  
Corona 1/2 Bowl

Kod Code	Ölçü (cm) Dim (cm)	Kapasite Capacity	Koli/Adet Pcs/Ctn
90042012	32,5x26,5x7,5	3,8 Lt	6

900 901 902  
■ ■ ▢



» Corona 1/4 Kase  
Corona 1/4 Bowl

Kod Code	Ölçü (cm) Dim (cm)	Kapasite Capacity	Koli/Adet Pcs/Ctn
90042014	26,5x16,2x7,5	2 Lt	12

900 901 902  
■ ■ ▢



» Corona Kare Kase  
Corona Square Bowl

Kod Code	Ölçü (cm) Dim (cm)	Kapasite Capacity	Koli/Adet Pcs/Ctn
90042019	19x19x9	1,9 Lt	8
90042025	25x25x9	4,5 Lt	6

900 901 902  
■ ■ ▢



188

» Siyah Mermer Efekt Melamin Sunum Tahtası  
Black Marble Effect Melamine Display Board

Kod Code	Ölçü (cm) Dim (cm)	Model Model	Koli/Adet Pcs/Ctn
90017013	17,7x32,5	1/3	6
90017012	26,5x32,5	1/2	4
90017024	53x16,5	2/4	4
90017011	53x32,5	1/1	2

» Beyaz Mermer Efekt Melamin Sunum Tahtası  
White Marble Effect Melamine Display Board

Kod Code	Ölçü (cm) Dim (cm)	Model Model	Koli/Adet Pcs/Ctn
90117013	17,7x32,5	1/3	6
90117012	26,5x32,5	1/2	4
90117024	53x16,5	2/4	4
90117011	53x32,5	1/1	2



» Royal Mermer Efekt Melamin Sunum Tahtası  
Royal Marble Effect Melamine Display Board

Kod Code	Ölçü (cm) Dim (cm)	Koli/Adet Pcs/Ctn
90047013	16,2x32,5x1	9
90047012	26,5x32,5x1	6
90047011	53x32,5x1	3

» Royal Mermer Efekt Melamin Sunum Tahtası  
Royal Marble Effect Melamine Display Board

Kod Code	Ölçü (cm) Dim (cm)	Koli/Adet Pcs/Ctn
90047225	25x25x1	8
90047230	30x30x1	6

» Royal Mermer Efekt Melamin Sunum Tahtası  
Royal Marble Effect Melamine Display Board

Kod Code	Øxh (cm) Øxh (cm)	Koli/Adet Pcs/Ctn
90047030	30x1	6

## Açık Büfe Sunum Tepsi / Open Buffet Display Trays



» 1/1 GN Tepsi  
1/1 GN Tray

Kod Code	Ölçü (mm) Dim. (mm)	lt lt	Koli/Adet Pcs/Ctn
31611010	530x325x10	1,25	6
31611020	530x325x20	2,5	6
31611040	530x326x40	5	6

» 2/3 GN Tepsi  
2/3 GN Tray

Kod Code	Ölçü (mm) Dim. (mm)	lt lt	Koli/Adet Pcs/Ctn
31623010	354x325x10	0,75	6
31623020	354x325x20	1,5	6
31623040	354x325x40	3	6

» 1/2 GN Tepsi  
1/2 GN Tray

Kod Code	Ölçü (mm) Dim. (mm)	lt lt	Koli/Adet Pcs/Ctn
31612010	325x265x10	0,5	6
31612020	325x265x20	1,25	6
31612040	325x265x40	2,5	6



» Kayrak Sunum Tabak Natural Kenar  
Slate Display Plate Natural Edge

Kod Code	Ölçü (cm) Dim. (cm)
78001020	10x20
78001530	15x30
78002030	20x30
78001545	15x45
78001200	25x35

» Dikdörtgen Oluklu Sunum Tabak  
Slate Rectangular Grooved Display Plate

Kod Code	Ölçü (cm) Dim. (cm)
78003020	20x30
78002535	25x35
78004030	28x40

» Kayrak Kare Oluklu Tabak  
Slate Square Grooved Display Plate

Kod Code	Ölçü (cm) Dim. (cm)
78001515	15x15
78002020	20x20
78002525	25x25
78003030	30x30

189



» Baget Ekmeklik  
Baguette Basket (S/S)

Kod Code	Ölçü (cm) Dim. (cm)	Koli/Adet Pcs/Ctn
40100131	Ø 27x31	1
40100132	Ø 27x40	1



» Ekmek Sepeti  
Bread Basket (S/S)

Kod Code	Ölçü (cm) Dim. (cm)	Koli/Adet Pcs/Ctn
40101151	21x17x6	1
40101152	30x21x6	1
40101153	35x23,5x10	1
40101154	45x32x10	1

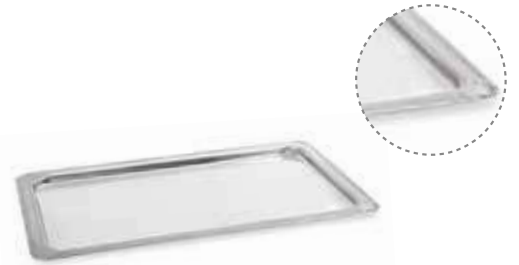

» Banket Tepsi Kenar Desenli  
Figured Tray for Open Buffet

Kod Code	Ölçü (cm) Dim. (cm)	Koli/Adet Pcs/Ctn
31611005	530x325	6

- %100 ahşap görümlü
- Bakteri barındırmaz
- +85°C / -40°C arası ısı dayanıklılığı
- Bulaşık makinesinde yıkanabilir
- Esnek malzemeden imal edilmiştir
- %100 wood view
- Antibacterial
- Heat intensive and endurance up to +85 and -40+85°C / -40°C
- Dishwasher safe
- Manufactured from elastic materials



» Derin Kase  
Deep Bowl

Kod Code	Ø (cm) Ø (cm)	Koli/Adet Pcs/Ctn
80011012	12,5	30
80011016	16	12
80011020	20	12
80011024	24	12



» Kare Derin Tabak  
Square Deep Bowl

Kod Code	Ölçü (cm) Dim. (cm)	Koli/Adet Pcs/Ctn
80010100	10x10x3,5	36
80010111	12,5x12,5x6	30
80010112	19,5x19,5x9,5	12
80010113	24x24x10,5	12
80010114	29x29x11	12
80010115	36x36x12	12



» Üçgen Derin Tabak  
Triangle Deep Bowl

Kod Code	Ölçü (cm) Dim. (cm)	Koli/Adet Pcs/Ctn
80011100	10x3,5	36
80011111	12x6	30
80011112	19,5x10	12
80011113	24x10,5	12
80011114	29x11	12
80011115	36x12	12



» Oval Tabak  
Eliptic Bowl

Kod Code	Ölçü (cm) Dim. (cm)	Koli/Adet Pcs/Ctn
80012230	22x30x8	12
80013624	36x24x8,5	12
80012740	27x40x8,5	12



» Yuvarlak Tabak  
Round Bowl

Kod Code	Ölçü (cm) Dim. (cm)	Koli/Adet Pcs/Ctn
80010015	Ø 16x4	24
80010020	Ø 21x5,5	12
80010025	Ø 26x7	12
80010030	Ø 30x8	12



» Yaprak Tepsi  
Leaf Display Tray

Kod Code	Ölçü (cm) Dim. (cm)	Koli/Adet Pcs/Ctn
80010211	25x45x3	6
80010212	33x57x3	6

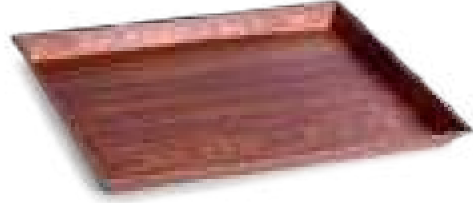

» Elit Tepsi  
Elite Tray

Kod Code	Ölçü (cm) Dim. (cm)	Koli/Adet Pcs/Ctn
80010133	31x39	6
80010134	35x42	6



» Sunum Tepsi  
Display Tray

Kod Code	Ölçü (cm) Dim. (cm)	Koli/Adet Pcs/Ctn
80010208	19x35,5x4	6
80010209	23x46x5	6
80010210	33x55x5	6



» Kare Tabak  
Square Bowl

Kod Code	Ölçü (cm) Dim. (cm)	Koli/Adet Pcs/Ctn
80012323	23x23x7	12
80012828	28x28x7,5	12



» Meze Küveti  
Appetizer Pan

Kod Code	Ölçü (cm) Dim. (cm)	Koli/Adet Pcs/Ctn
80012818	28x18,5x4	6
80013323	33x23x4	6
80013826	38x26x4	6



# Restaurant/ Table-Top

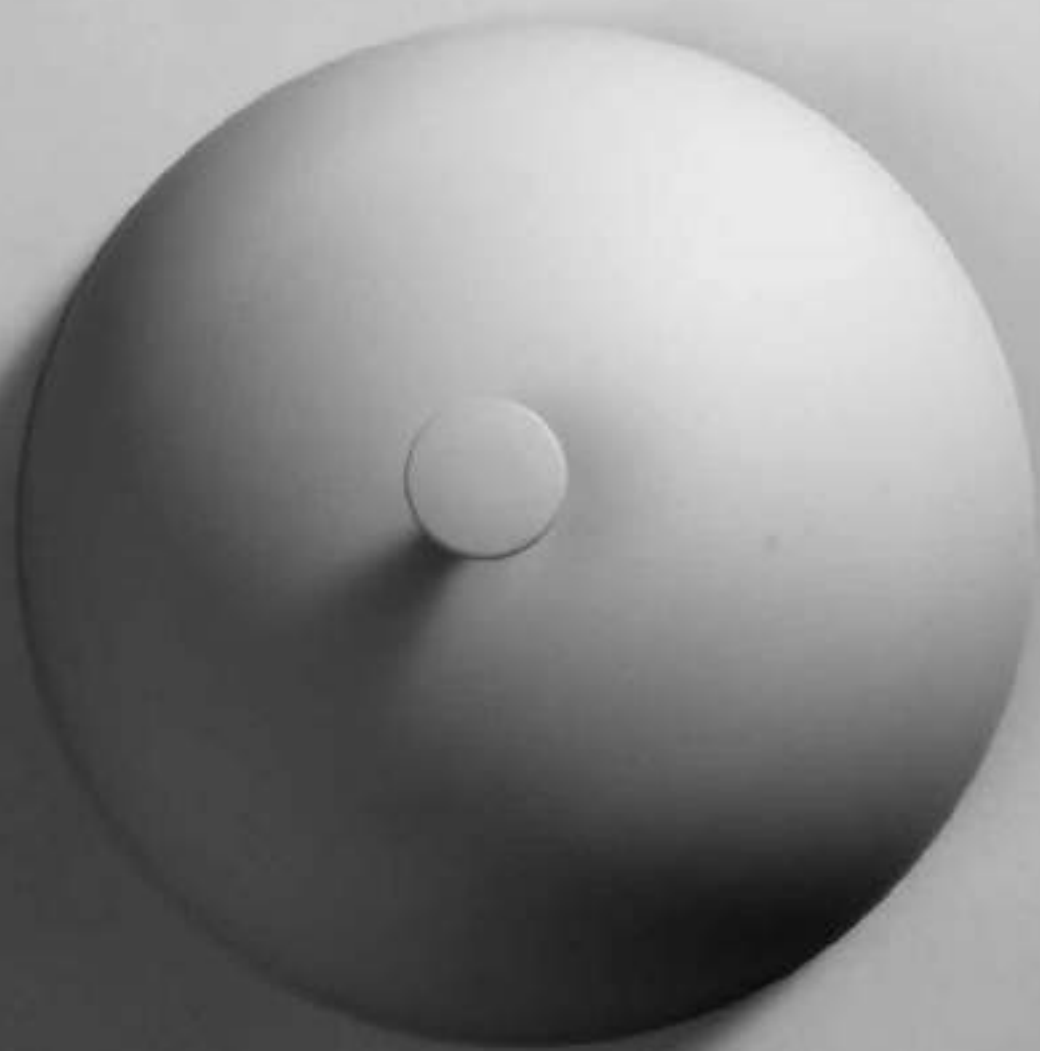





» Boğa Biftek Tahtası  
Bull Steak Display

Kod Code	Ölçü (cm) Dim. (cm)
69012637	26x37

6901



Ireko/Iroko

6902



Kayın/Beechwood



» Saplı Biftek Tahtası  
Steak Display w/handle

Kod Code	Ölçü (cm) Dim. (cm)
69012043	20x43
69012547	25x47
69013242	32x42

6901



Ireko/Iroko

6902



Kayın/Beechwood



» Klasik Steak Tahtası  
Classic Display

Kod Code	Ölçü (cm) Dim. (cm)
69012335	23x35
69012538	25,5x38,5

6901



Ireko/Iroko

6902



Kayın/Beechwood



» Geometrik Sunumluk  
Geometrical Display

Kod Code	Ölçü (cm) Dim. (cm)
69012038	20x38

6901



Ireko/Iroko

6911



Kayın/Beechwood



» Saplı Peynir Sunumluk  
Cheese Display w/handle

Kod Code	Ölçü (cm) Dim. (cm)
69011547	15x47

6901



Ireko/Iroko

6902



Kayın/Beechwood

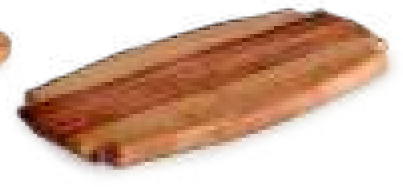

» Klasik Peynir Sunumluk  
Classic Cheese Display

Kod Code	Ölçü (cm) Dim. (cm)
69011635	16x35

6901



Ireko/Iroko

6902



Kayın/Beechwood



» Saplı Pizza Sunumluk (Ireko)  
Pizza Display w/handle (Ireko)

Kod Code	Ø (cm) Ø (cm)
69010028	28

6901



Ireko/Iroko

6902



Kayın/Beechwood



» Yuvarlak Sunumluk (Ireko)  
Round Display (Ireko)

Kod Code	Ø (cm) Ø (cm)
69011028	28

6901



Ireko/Iroko

6902



Kayın/Beechwood



» Elips Sunumluk (Ireko)  
Elips Display (Ireko)

Kod Code	Ölçü (cm) Dim. (cm)
69012745	17x45

6901



Ireko/Iroko

6902



Kayın/Beechwood



» PC Düz Tabak  
PC Flat Plate

Kod Code	Ø (cm) Ø (cm)	Koli/Adet Pcs/Ctn
46040013	13	100
46040015	15	100
46040017	17	108
46040019	19	108
46040021	21	108
46040023	23	72
46040025	25	72
46040028	28	72



» PC Çukur Tabak  
PC Soup Plate

Kod Code	Ø (cm) Ø (cm)	Koli/Adet Pcs/Ctn
46030019	19	72
46030021	21	72



» PC Oluklu Tabak  
PC Ribbed Plate

Kod Code	Ø (cm) Ø (cm)	Koli/Adet Pcs/Ctn
46050017	17	72
46050018	18,5	72



» PC Pizza Tabağı  
PC Pizza Plate

Kod Code	Ø (cm) Ø (cm)	Koli/Adet Pcs/Ctn
46050032	32	24



» PC Kare Kayık Tabak  
PC Appetizer Plate

Kod Code	Ölçü (cm) Dim. (cm)	Koli/Adet Pcs/Ctn
46020210	12	108
46020014	14	108
46020017	17	108
46020020	20	108



» PC Kayık Tabak  
PC Shallow Platter

Kod Code	Ölçü (cm) Dim. (cm)	Koli/Adet Pcs/Ctn
46011114	14	108
46010024	24	72
46010029	29	48
46010034	34	24

195



» PC Çorba Kasesi & Kapak  
PC Bowl & Cover

Kod Code	Model Model	Ø (cm) Ø (cm)	Koli/Adet Pcs/Ctn
46050012	Kase/Bowl	12	108
46150017	Kapak/Cover	12	108



» PC Tabak Kapağı  
PC Plate Cover

Kod Code	Ø (cm) Ø (cm)	Koli/Adet Pcs/Ctn
46050023	23,5	72



» PC Kayık Tabak Kapağı  
PC Appetizer Plate Cover

Kod Code	Ölçü (cm) Dim. (cm)	Koli/Adet Pcs/Ctn
46010224	24	72

\* 2000 adet ve üzerinde renk opsiyonları mevcuttur (siyah,sarı,kırmızı)

\* Color options are available for quantities of 2,000 or more (black, yellow, red)



NEW

» Karabiber Değirmeni Hostellerie  
Pepper Mill Hostellerie



Kod Code	Renk Color	Ölçü (cm) Dim. (cm)	Koli/Adet Pcs/Ctn
66022222	Çikolata /Chocolate	22	1
66022322	Natural / Natural	22	1



NEW

» Karabiber Değirmeni Auberge  
Pepper Mill Auberge



Kod Code	Renk Color	Ölçü (cm) Dim. (cm)	Koli/Adet Pcs/Ctn
66022227	Çikolata /Chocolate	27	1
66022327	Natural / Natural	27	1



Tuzluk  
Salt

Karabiber  
Pepper

NEW

» Paris  
Paris



Kod Code	Model Model	Ölçü (cm) Dim. (cm)	Koli/Adet Pcs/Ctn
66032218	Tuz /Salt	18	1
66022218	Karabiber / Pepper	18	1

S/S Mekanizma  
S/S Mechanism



» Paso Natural  
Paso Natural

de Buyer  
DEPUIS 1830

Kod Code	Model Model	Ölçü (cm) Dim. (cm)	Koli/Adet Pcs/Ctn
66012110	Karabiber / Pepper	10	1



S/S Mekanizma  
S/S Mechanism



Çelik Mekanizma  
Steel Mechanism



» Rumba  
Rumba

de Buyer  
DEPUIS 1830

Kod Code	Model Model	Ölçü (cm) Dim. (cm)	Koli/Adet Pcs/Ctn
66051320	Tuz /Salt	20	1
66052320	Karabiber / Pepper	20	1



» Java Natural Karabiber Değirmeni  
Java Natural Pepper Mill

de Buyer  
DEPUIS 1830

Kod Code	Ölçü (cm) Dim. (cm)	Koli/Adet Pcs/Ctn
66022121	21	1
66022125	25	1
66022130	30	1
66022180	70	1



» Java Dark Karabiber Değirmeni  
Java Dark Pepper Mill

de Buyer  
DEPUIS 1830

Kod Code	Ölçü (cm) Dim. (cm)	Koli/Adet Pcs/Ctn
66022221	21	1
66022225	25	1
66022230	30	1
66022280	70	1

» Java Dark Tuz Değirmeni  
Java Dark Salt Mill

de Buyer  
DEPUIS 1830

Kod Code	Ölçü (cm) Dim. (cm)	Koli/Adet Pcs/Ctn
66021214	14	1

197



» Ahsap Degirmen (Çelik Bıçaklı)  
Rubber Wood (S/S) Grinder

Kod Code	Model Model	Ölçü (cm) Dim. (cm)	Koli/Adet Pcs/Ctn
53011013	Tuz Değirmeni / Salt Mill	13	4
53012013	Değirmen / Pepper Mill	13	4
53011021	Değirmen / Pepper Mill	21	2
53011031	Değirmen / Pepper Mill	31	2
53011041	Değirmen / Pepper Mill	41	1
53011046	Değirmen / Pepper Mill	46	1



» Standlı Tuzluk & Biberlik Set  
Salt & Pepper Set With Stand

Kod Code	Renk Color	Koli/Adet Pcs/Ctn
36305003	Siyah / Black	1
36305004	Bronz / Bronze	1



» Çöp Kovası Büfe  
Waste Bin Buffet

Kod Code	Ölçü (cm) Dim (cm)	Koli/Adet Pcs/Ctn
93000010	14x17	1



» Masa Rezerve İsimlik  
Table Sign Reserved

Kod Code	Ölçü (cm) Dim (cm)	Koli/Adet Pcs/Ctn
93000002	10,5x5	1

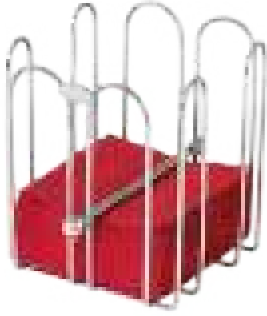

» Rüzgar Koruyucu Peçetelik  
Windscreen Napkin Holder

Kod Code	Ölçü (cm) Dim (cm)	Koli/Adet Pcs/Ctn
93000007	14,5x14,5x16,5	1



» Rüzgar Koruyucu Peçetelik  
Windscreen Napkin Holder

Kod Code	Ölçü (cm) Dim (cm)	Koli/Adet Pcs/Ctn
93000008	14,5x14,5x9	1



» Peçetelik Düz Yüzeyle Paslanmaz  
Napkin Holder Flat Stainless Steel

Kod Code	Ölçü (cm) Dim (cm)	Koli/Adet Pcs/Ctn
93000027	11x7	1



» Yarım Ay Delikli Peçetelik  
Napkin Holder Perforated Half Moon

Kod Code	Ölçü (cm) Dim (cm)	Koli/Adet Pcs/Ctn
93000001	13x5x6,5	1



» Küllük Delikli Paslanmaz  
Ashtray Perforated Stainless Steel

Kod Code	Ölçü (cm) Dim (cm)	Koli/Adet Pcs/Ctn
93000018	8,5x8,5x3,5	1



» Peçetelik Delikli Paslanmaz  
Napkin Holder Perforated Stainless Steel

Kod Code	Ölçü (cm) Dim (cm)	Koli/Adet Pcs/Ctn
93000024	11x6x4,5	1



» Kürdanlık Delikli Paslanmaz  
Toothpick Holder Perforated Stainless Steel

Kod Code	Ölçü (cm) Dim (cm)	Koli/Adet Pcs/Ctn
93000021	7x5	1



» Çelik Ekmek Sepeti Delikli  
Bread Basket Perforated Stainless Steel

Kod Code	Ölçü (cm) Dim (cm)	Koli/Adet Pcs/Ctn
93000022	15,5x6	1



» Küllük Çizgili Paslanmaz  
Ashtray Striped Stainless Steel

Kod Code	Ölçü (cm) Dim (cm)	Koli/Adet Pcs/Ctn
93000026	8,5x8,5x3,5	1



» Peçetelik Çizgili Paslanmaz  
Napkin Holder Striped Stainless Steel

Kod Code	Ölçü (cm) Dim (cm)	Koli/Adet Pcs/Ctn
93000024	11x6x4,5	1



» Kürdanlık Çizgili Paslanmaz  
Toothpick Holder Striped Stainless Steel

Kod Code	Ölçü (cm) Dim (cm)	Koli/Adet Pcs/Ctn
93000025	7x5	1



» Çelik Ekmek Sepeti Çizgili  
Bread Basket Striped Stainless Steel

Kod Code	Ölçü (cm) Dim (cm)	Koli/Adet Pcs/Ctn
93000023	15,5x6	1



» Kırıntı Küreği  
Table Crumbler

Kod Code	Koli/Adet Pcs/Ctn
44010001	6



» Peçetelik  
Napkin Holder

Kod Code	Ölçü (cm) Dim. (cm)	Koli/Adet Pcs/Ctn
56012112	15x3x10	6



» Dikdörtgen Sunum Sepeti  
Rectangular Display Basket

Kod Code	Ölçü (cm) Dim. (cm)	Koli/Adet Pcs/Ctn
56032110	21x10x3,5	6

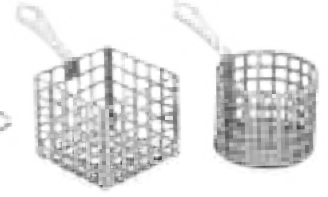

» Patates Sepeti  
Miniature French Fries Basket

Kod Code	Ölçü (cm) Dim. (cm)	Koli/Adet Pcs/Ctn
40160501	7,5x7,5x6	1
40160502	Ø 7,5x6	1



200 » Polikarbonat Tuzluk & Biberlik  
PC Salt & Pepper

Kod Code	Model Model	Koli/Adet Pcs/Ctn
46010070	Tuzluk / Salt Sprinkler	40
46010071	Karabiberlik / Pepper Sprinkler	40
46010074	Kürdanlıklı Set/ Set w/Toothpick	48



» PC Şekerlik  
PC Sugar Bowl

Kod Code	Ölçü (cm) Dim. (cm)	Koli/Adet Pcs/Ctn
46010004	12x8	6



» PC Baharatlık  
PC Cruet

Kod Code	Ölçü (cm) Dim. (cm)	Koli/Adet Pcs/Ctn
46010006	6,8x5,7	6

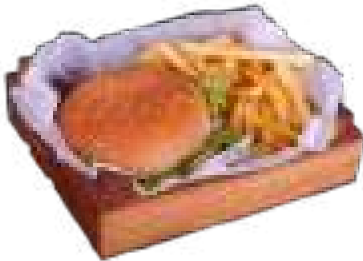

» Sunum Sandık  
Wooden Display Box

Kod Code	Ölçü (cm) Dim. (cm)	Koli/Adet Pcs/Ctn
69001417	14x17	1
<b>6900</b>	<b>6901</b>	
İreko/Iroko	Kayın/Beachwood	



» Sunum Sandık Derin  
Wooden Deep Display Box

Kod Code	Ölçü (cm) Dim. (cm)	Koli/Adet Pcs/Ctn
69002030	20x30	1
<b>6900</b>	<b>6901</b>	
İreko/Iroko	Kayın/Beachwood	



» Ahşap Sos Kutusu  
Wooden Sauce Box

Kod Code	Ölçü (cm) Dim. (cm)	Koli/Adet Pcs/Ctn
69011422	14x22	1
69011527	15x27	1



» Masa Lambası  
Table Lamp

Kod Code	Ölçü (cm) Dim (cm)	Renk Color	Koli/Adet Pcs/Ctn
93000019	26,5x10,5	Siyah / Black	1
93000020	26,5x10,5	Krom / Chrome	1



» Tabak Kapağı  
Plate Cover

Kod Code	Ø (cm) Ø (cm)	Koli/Adet Pcs/Ctn
56011270	27	6
56011300	30	6



» Sunum Kapağı  
Display Cover

Kod Code	Ø (cm) Ø (cm)	Koli/Adet Pcs/Ctn
40335005	20,5	1
40335006	23	1
40335007	26	1



» Sos Teknesi  
Gravy Boat

Kod Code	Kapasite (ml) Capacity (ml)	Koli/Adet Pcs/Ctn
58010727	150	6
58010728	300	6



» Ayaklı Kadeh (Dondurmalık)  
Ice Cream Cup

Kod Code	Ölçü (cm) Dim. (cm)	Koli/Adet Pcs/Ctn
35201000	6,5	1
35202000	8	1
35203000	9	1
35204000	10	1



» Dondurmalık  
Ice Cream Cup

Kod Code	Ölçü (cm) Dim. (cm)	Koli/Adet Pcs/Ctn
35200001	8	1
35200002	8,5	1
35200003	9,5	1



» Ekmek Kasası  
Bread Basket

Kod Code	Ölçü (cm) Dim. (cm)	Koli/Adet Pcs/Ctn
37302015	20x15x8	1

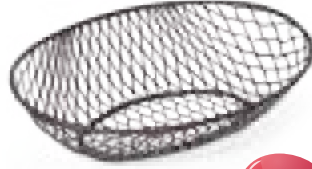

NEW

» Oval Sunum Tel Sepet Siyah  
Eliptic Display Basket Black

Kod Code	Ölçü (cm) Dim (cm)	Koli/Adet Pcs/Ctn
36307010	23x18x6	1
36307012	28x20x6	1

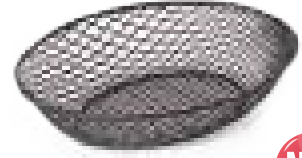

NEW

» Yuvarlak Sunum Tel Sepet Siyah  
Round Display Basket Black

Kod Code	Ø (cm) Ø (cm)	Koli/Adet Pcs/Ctn
36307000	16	1
36307002	20	1



» Çelik Ekmek Sepeti  
Bread Basket (S/S)

Kod Code	Ölçü (cm) Dim. (cm)	Koli/Adet Pcs/Ctn
40101151	21x17x6	1
40101152	30x21x6	1



» Çelik Tel Ekmek Sepeti  
Bread/Fruit Basket (S/S)

Kod Code	Ölçü (cm) Dim. (cm)	Koli/Adet Pcs/Ctn
57012210	Ø 22x9,5	6
57012410	Ø 24x0,5	6
57012611	Ø 26x11,5	6

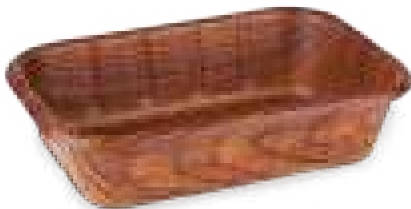

» Köşeli Ekmek Sepeti  
Rectangular Basket

Kod Code	Ölçü (cm) Dim. (cm)	Koli/Adet Pcs/Ctn
80011118	14,5x21x5	18
80011119	18,5x25,5x7	12

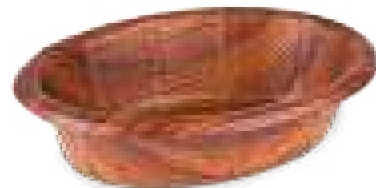

» Oval Ekmek Sepeti  
Oval Basket

Kod Code	Ölçü (cm) Dim. (cm)	Koli/Adet Pcs/Ctn
80011116	15x20x5	18
80011117	21x30x7,5	12

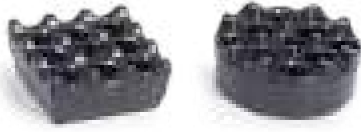

» Döküm  
Casted Black Ashtray

Kod Code	Model Model	Ölçü (cm) Dim. (cm)	Koli/Adet Pcs/Ctn
43040004	Kare/Square	8x8x3,5	6
43040005	Yuvarlak/Round	Ø 9,3x4	6



» Döküm  
Casted Ashtray

Kod Code	Model Model	Ölçü (cm) Dim. (cm)	Koli/Adet Pcs/Ctn
40350013	Kare/Square	8x8x3,5	6
43040001	Yuvarlak/Round	Ø 9,3x4	6



» Döküm Bronz  
Casted Bronze Ashtray

Kod Code	Model Model	Ölçü (cm) Dim. (cm)	Koli/Adet Pcs/Ctn
43040002	Kare/Square	8x8x3,5	6
43040003	Yuvarlak/Round	Ø 9,3x4	6



» Havuzlu  
Ashtray w/Cover

Kod Code	Model Model	Koli/Adet Pcs/Ctn
35930000	Kare/Square	6
35940000	Yuvarlak/Round	6



» Pirinç  
Brass Ashtray

Kod Code	Model Model	Ölçü (cm) Dim. (cm)	Koli/Adet Pcs/Ctn
43040006	Kare/Square	8x8x3,5	6
43040007	Yuvarlak/Round	Ø 9,3x4	6



» Havuzlu Rüzgarlıkl  
Wind Protected Ashtray

Kod Code	Model Model	Koli/Adet Pcs/Ctn
43040011	Küçük/Small	10
43040010	Büyük/Big	10



» Ayaklı Küllük Stand  
Ashtray Stand

Kod Code	h (cm) h (cm)	Koli/Adet Pcs/Ctn
40010004	76	1



» Puro Küllüğü  
Cigar Ashtray

Kod Code	Ölçü (cm) Dim (cm)	Koli/Adet Pcs/Ctn
93000003	16,5x8x3	1

**İçecek/Beverage**







**NEW** Cento



» Cento Espresso Makinesi Tall Cup  
Cento Espresso Machine Tall Cup

Kod Code	Grup Group	Kapasite (lt) Capacity (lt)
65000011	2	11
65000014	3	14

206

	2 Group	3 Group
Güç / Power	3150 W	4350 W
Güç Kaynağı / Power Source	230 V 50/60 Hz	230 V 50/60 Hz
Kazan Kapasitesi / Boiler Capacity	11 Lt	14 Lt
Net Ağırlık / Net Weight	47 Kg	61 Kg
Ölçüler / Dimensions	722x497x515 mm	942x497x515 mm

- Dijital Sıcaklık Kontrolü
- Elektronik ön-demleme
- Elektronik yıkama döngüsü
- Entegre volumetrik pompa
- Emniyet valfi
- Yüksek bardak için uygun
- 220 - 240 V 50/60 Hz

- Digital Temperature Control
- Electronic pre-infusion
- Electronic washing cycle
- Integrated volumetric pump
- Safety valve
- High cup
- 220 - 240 V 50/60 Hz





**NEW** DivaPRO



» DivaPro Espresso Makinesi Tall Cup  
DivaPro Espresso Machine Tall Cup

Kod Code	Grup Group	Kapasite (lt) Capacity (lt)
65000115	2	11,5

	2 Group
Güç / Power	5100 W
Güç Kaynağı / Power Source	230 V 50/60 Hz
Kazan Kapasitesi / Boiler Capacity	11,5 Lt
Net Ağırlık / Net Weight	70 Kg
Ölçüler / Dimensions	800x574x515 mm

- Yüksek verimlilik için grup karıştırma vanasıyla uyumlu büyük kazan, sürekli kullanım için tasarlanmıştır
- Cool touch buhar çubuğu
- Her grup için özelleştirilebilir sıcaklık ayarı
- Entegre volumetrik pompa
- Su karıştırma vanası
- Otomatik süt köpürtücü
- Elektronik yıkama döngüsü
- Emniyet valfi
- Yüksek fincan

- Large boiler for high productivity in line with group mixing valve for continuous delivery
- Cool touch steam wand
- Customizable temperature for each group
- Integrated volumetric pump
- Water mixing valve
- Automatic milker
- Electronic washing cycle
- Safety valve
- High cup





## NEW Barlume



» Barlume Espresso Makinesi Tall Cup  
Barlume Espresso Machine Tall Cup

Kod Code	Grup Group	Kapasite (lt) Capacity (lt)
65000013	2	13

208

	2 Group
Güç / Power	3700 W
Güç Kaynağı / Power Source	220 - 240 V 50/60 Hz
Kazan Kapasitesi / Boiler Capacity	13 Lt
Net Ağırlık / Net Weight	73 Kg
Ölçüler / Dimensions	850x510x530 mm

- Elektronik sıcaklık kontrolü
  - Uzun fincan modeli
  - Aydınlatmalı krom/pleksiglas opal gövde
  - Otomatik 5 doz ön ayar cihazı
  - Düşük enerji tüketimi / Programlanabilir gece modu
  - Ahşap kontrol düğmesine sahip buhar/su musluğu
  - Çift ölçekli yüksek hassasiyetli basınç göstergesi
  - Ahşap ergonomik filtre tutucu saplar
  - 1 litre kapasiteye kadar sürrahiler için çift mahfaza
  - Opal pleksiglas fincan koruma kapağı
- *Electronic temperature control*
  - *Tall cup model*
  - *Illuminated chrome/plexiglass opal body*
  - *Automatic 5 doses device presetting*
  - *Reduced energy consumption/ Programmable night cycle*
  - *Steam/water tap with knob control in wood*
  - *High precision gauge with double scale*
  - *Ergonomic filterholder handles in wood*
  - *Double housing for pitchers till 1 lt capacity*
  - *Opaline plexiglass cup protection cover*





**NEW**

### LA CARIMALI

» On Demand Kahve Değirmeni  
On Demand Coffee Grinder

Kod Code	Kapasite Capacity
65000058	1Lt

Güç Kaynağı / Power Source	220 - 240 V 50/60 Hz
Burr Çapı / Burrs diameter	58 mm
Hazne Kapasitesi / Hopper Capacity	1 Kg
Ağırlık / Weight	7,3 Kg
Ölçüler / Dimensions	194x430x308 mm

Güç Kaynağı / Power Source	220 - 240 V 50/60 Hz
Burr Çapı / Burrs diameter	58 mm
Hazne Kapasitesi / Hopper Capacity	1,2 Kg
Ağırlık / Weight	7,5 Kg
Ölçüler / Dimensions	194x430x308 mm

**NEW**

### LA CARIMALI

» On Demand Dokunmatik Kahve Değirmeni  
On Demand Touch Coffee Grinder

Kod Code	Kapasite Capacity
65000158	1,2 Lt



209

- Çekirdek silosu: 1.6 Kg
- Mikrometrik öğütme ayarı
- LCD gösterge
- LED aydınlatma
- Epoksi boyalı döküm alüminyum gövde
- Bıçak çapı: 65 mm
- Öğütme kapasitesi: 9 Kg / gün
- Ölçüler: 212 x 290 x 585 mm
- 230 / 50 / 1 - 500 W att

- Core silo: 1.6 Kg
- Micrometric grinding adjustment
- LCD display
- LED lighting
- Epoxy painted casting aluminum body
- Blade diameter: 65 mm
- Grinding capacity: 9 Kg / day
- Dimensions: 212 x 290 x 585 mm
- 230 / 50 / 1 - 500 W att

» On Demand Kahve Değirmeni  
On Demand Coffee Grinder



Kod Code	Kapasite (lt) Capacity (lt)	Renk Color
71010019	11 Lt	Siyah/Black
71110019	11 Lt	Beyaz/White





» Süt Potu  
Milk Pot

Kod Code	ml ml	Ad./Koli Pcs/Ctn
62010300	300	6



» Süt Potu  
Milk Pot

Kod Code	ml ml	Ad./Koli Pcs/Ctn
62010800	800	2



» Dereceli Süt Potu  
Measuring Milk Pot

Kod Code	ml ml	Ad./Koli Pcs/Ctn
62010600	600	2



» Klipsli Kahve Termometresi  
Coffee Thermometer With Jug Clip

Kod Code	Ölçü (cm) Dim. (cm)	Ad./Koli Pcs/Ctn
71010010	12,7	6



» Klipsli Kahve Ölçü Kaşığı  
Coffee Scoop With Clip

Kod Code	Ölçü (cm) Dim. (cm)	Ad./Koli Pcs/Ctn
71010012	18	6



» Latte Kalemi  
Latte Art Pen

Kod Code	Ölçü (cm) Dim. (cm)	Ad./Koli Pcs/Ctn
71010013	13,5	6



» Kahve Tamperi  
Coffee Tamper

Kod Code	Ölçü (mm) Dim. (mm)	Ad./Koli Pcs/Ctn
71010011	57	6

**NEW**

- Ağırlık : 6,3 kg
- Sıcaklık Aralığı +30 ° C... 90 ° C
- Isıtma Gücü 1000W
- Akım 4,5 A
- Besleme Voltajı 220-240 V 50 Hz

- Weight: 6.3 kg
- Temperature Range: +30°C... 90°C
- Heating Power: 1000W
- Current: 4.5 A
- Supply Voltage: 220-240 V 50 Hz

» Sıcak ikolata Salep Makinası  
Hot Beverage Dispenser

Kod Code	Kapasite (lt) Capacity (lt)	Ölü (cm) Dim. (cm)
59150005	5	27,5x36X45

211



- Ağırlık : 6,9 kg
- Sıcaklık Aralığı +30 ° C... 90 ° C
- Isıtma Gücü 1500W
- Akım 5,5 A
- Besleme Voltajı 220-240 V 50 Hz

- Weight: 6.9 kg
- Temperature Range: +30°C... 90°C
- Heating Power: 1500W
- Current: 5.5 A
- Supply Voltage: 220-240 V 50 Hz

» orbalık Siyah Karıştırıcı  
Soup Dispenser

Kod Code	Kapasite (lt) Capacity (lt)	Ölü (cm) Dim. (cm)
59010010	10	27,5x36X53,5

NEW



- Ağırlık : 16,4 kg
- Soğutucu Gaz R134A / R290
- Sıcaklık Aralığı +3 ° C... +10 ° C
- Soğutma Gücü 350W
- Güç 160W
- Akım 1,1A
- Besleme Voltajı: 220-240 V 50 Hz

- Weight: 6.9 kg
- Refrigerant Gas: R134A / R290
- Temperature Range: +3°C... +10°C
- Cooling Capacity: 350W
- Power: 160W
- Current: 1.1A
- Supply Voltage: 220-240 V 50 Hz

» Şerbetlik / Limonata Makinası  
Juice Cooler

Kod Code	Kapasite (lt) Capacity (lt)	Ölçü (cm) Dim. (cm)
59250010	10	25x39x71



591

212



- Ağırlık : 20 kg
- Soğutucu Gaz R134A / R290
- Sıcaklık Aralığı +3 ° C... +10 ° C
- Soğutma Gücü 500W
- Güç 250W
- Akım 1,4A
- Besleme Voltajı: 220-240 V 50 Hz

- Weight: 6.9 kg
- Refrigerant Gas: R134A / R290
- Temperature Range: +3°C... +10°C
- Cooling Capacity: 500W
- Power: 250W
- Current: 1.4A
- Supply Voltage: 220-240 V 50 Hz

» Şerbetlik / Limonata Makinası  
Juice Cooler

Kod Code	Kapasite (lt) Capacity (lt)	Ölçü (cm) Dim. (cm)
59250022	22	35x40,5x75,5



591

**NEW**



- Ağırlık : 23 kg
- Soğutucu Gaz R134A / R290
- Sıcaklık Aralığı +3 ° C... +10 ° C
- Soğutma Gücü 750W
- Güç 250W
- Akım 1,45A
- Besleme Voltajı: 220-240 V 50 Hz

- Weight: 23 kg
- Refrigerant Gas: R134A / R290
- Temperature Range: +3°C... +10°C
- Cooling Capacity: 750W
- Power: 250W
- Current: 1.45A
- Supply Voltage: 220-240 V 50 Hz

» Şerbetlik / Limonata Makinası  
Juice Cooler

Kod Code	Kapasite (lt) Capacity (lt)	Ölçü (cm) Dim. (cm)
59250040	40	45x45x82,5



591

213



- Ağırlık : 32,5 kg
- Soğutucu Gaz R134A / R290
- Sıcaklık Aralığı +5 ° C... +10 ° C
- Soğutma Gücü 750W
- Güç 310W
- Akım 1,55A
- Besleme Voltajı: 220-240 V 50 Hz

- Weight: 32,5 kg
- Refrigerant Gas: R134A / R290
- Temperature Range: +5°C... +10°C
- Cooling Capacity: 750W
- Power: 310W
- Current: 1.55A
- Supply Voltage: 220-240 V 50 Hz

» Şerbetlik Kare  
Juice Cooler

Kod Code	Kapasite (lt) Capacity (lt)	Ölçü (cm) Dim. (cm)
59150040	20	36,5x52,5x66,5



590

**NEW**

- Ağırlık : 43,5 kg
- Defrost Modu: Mekanik
- Soğutucu Gaz: R404A / R290
- Soğutma Gücü: 984W
- Güç: 510W
- Akım: 2,31A
- Besleme Voltajı: 220-240 V 50 Hz

- Weight: 43,5 kg
- Defrost Mode: Mechanical
- Refrigerant Gas: R404A / R290
- Cooling Capacity: 984W
- Power: 510W
- Current: 2.31A
- Supply Voltage: 220-240 V 50 Hz

» Buzlu İçecek Makinası  
Ice Slush Dispenser

Kod Code	Kapasite (lt) Capacity (lt)	Ölçü (cm) Dim. (cm)
59210024	12x2	39x53x77

**591**

214



- Ağırlık : 61,3 kg
- Defrost Modu: Mekanik
- Soğutucu Gaz: R404A / R290
- Soğutma Gücü: 1400W
- Güç: 990W
- Akım: 3,84A
- Besleme Voltajı: 220-240 V 50 Hz

- Weight: 61,3 kg
- Defrost Mode: Mechanical
- Refrigerant Gas: R404A / R290
- Cooling Capacity: 1400W
- Power: 990W
- Current: 3,8A
- Supply Voltage: 220-240 V 50 Hz

» Buzlu İçecek Makinası  
Ice Slush Dispenser

Kod Code	Kapasite (lt) Capacity (lt)	Ölçü (cm) Dim. (cm)
59110036	12x3	39x53x77

**590**

**NEW**

» Köpük Ayran Makinası  
Cooler & Dispenser

Kod Code	Kapasite (lt) Capacity (lt)	Ölçü (cm) Dim. (cm)
59140022	22	35x40,5x82,5

- Ağırlık : 21,8kg
- Soğutucu Gaz R134A / R290
- Sıcaklık Aralığı +3 ° C... +10 ° C
- Soğutma Gücü 500W
- Güç 255W
- Akım 1,3 A
- Besleme Voltajı 220-240 V 50 Hz

- Weight: 21,8 kg
- Refrigerant Gas: R134A / R290
- Temperature Range: +3°C... +10°C
- Cooling Capacity: 500W
- Power: 255W
- Current: 1.3A
- Supply Voltage: 220-240 V 50 Hz

215



» Köpük Ayran Makinası  
Cooler & Dispenser

Kod Code	Kapasite (lt) Capacity (lt)	Ölçü (cm) Dim. (cm)
59140040	40	45x45x89

- Ağırlık :25 kg
- Soğutucu Gaz R134A / R290
- Sıcaklık Aralığı +3 ° C... +10 ° C
- Soğutma Gücü 750W
- Güç 285W
- Akım 1,45 A
- Besleme Voltajı 220-240 V 50 Hz

- Weight: 25 kg
- Refrigerant Gas: R134A / R290
- Temperature Range: +3°C... +10°C
- Cooling Capacity: 750W
- Power: 285W
- Current: 1.45A
- Supply Voltage: 220-240 V 50 Hz

- Karbonatlı olmayan tüm içecekleri soğutmak için tasarlanmıştır
- Kullanımı kolay ve çok yönlü
- Karıştırma paletiyle birlikte
- Hızlı ve kolay temizlik
- Hermetik kompresör
- Hava soğutmalı kondanser
- Darbeye dayanıklı, gıda sınıfı polikarbonat kaseler
- Paslanmaz çelik yapı

- *Designed to cool all non-carbonated drinks*
- *Easy to use and versatile*
- *w/ Stirring paddle*
- *Quick and easy cleaning*
- *Hermetic compressor*
- *Air cooled condenser*
- *Shockproof polycarbonate food grade bowls*
- *S/S structure*



## » Şerbetlik

## COMPACT 8/2

Juice Cooler

Kod Code	Kapasite (lt) Capacity (lt)	Ölçü (cm) Dim. (cm)
59040016	2x8	25x40x63

216

- Tüm içecek türlerini soğutmak için tasarlanmıştır
- Kullanımı kolay ve çok yönlü
- Fiskiye pompasıyla birlikte
- Hızlı ve kolay temizlik
- Hermetik kompresör
- Hava soğutmalı kondanser
- Darbeye dayanıklı, gıda sınıfı polikarbonat kaseler
- Paslanmaz çelik yapı

- *Designed to cool all types of drinks*
- *Easy to use and versatile*
- *w/ Fountain pump*
- *Quick and easy cleaning*
- *Hermetic compressor*
- *Air cooled condenser*
- *Shockproof polycarbonate food grade bowls*
- *S/S structure*



## » Şerbetlik

## DELUX

Juice Cooler

Kod Code	Kapasite (lt) Capacity (lt)	Ölçü (cm) Dim. (cm)
59040012	12	18x47x57
59040024	12x2	36x47x57



- Tüm doğal meyve suları için tasarlanmıştır
- Kullanımı kolay ve çok yönlü
- Karıştırma paletiyle birlikte
- Dijital termometreyle birlikte
- Hızlı ve kolay temizlik
- Hermetik kompresör
- Hava soğutmalı kondansör
- Darbeye dayanıklı, gıda sınıfı polikarbonat kaseler
- Paslanmaz çelik yapı
- 220 V

- *Designed for all natural fruit juices*
- *Easy to use and versatile*
- *w/ Stirring paddle*
- *w/Digital thermometer*
- *Quick and easy cleaning*
- *Hermetic compressor*
- *Air cooled condenser*
- *Shockproof polycarbonate food grade bowls*
- *S/S structure*
- *220 V*

» Ayran & Şerbet Soğutucu  
Cooler & Dispenser

Kod Code	Kapasite (lt) Capacity (lt)	Ölçü (cm) Dim. (cm)
59040019	19	35x38x71,3

A 19

217



- Sıcak çikolata ve tüm yoğun içecekleri karıştırmak için tasarlanmıştır
- Kullanımı kolay ve çok yönlü
- Karıştırma paletiyle birlikte
- Çift termostatlı
- Hızlı ve kolay temizlik
- Darbeye dayanıklı, gıda sınıfı polikarbonat kaseler
- Paslanmaz çelik yapı
- 220 V - 1300 Watt

- *Designed to mix hot chocolate and all thick drinks*
- *Easy to use and versatile*
- *w/ Stirring paddle*
- *w/Double thermostate*
- *Quick and easy cleaning*
- *Shockproof polycarbonate food grade bowls*
- *S/S structure*
- *220 V - 1300 Watt*

» Sıcak Çikolata / Sahlep Makinesi  
Hot Chocolate Dispenser

Kod Code	Kapasite (lt) Capacity (lt)	Ölçü (cm) Dim. (cm)
59040005	5	26x32x49,5

Delice

- Granita ve buzlu içecekler hazırlamak ve dağıtmak için tasarlanmıştır
- Manyetik sistem karıştırıcı
- Özel, patentli manyetik iletim sistemi
- Çok yönlü kolay kullanım
- Hızlı ve kolay temizlik
- Hermetik kompresör
- Hava soğutmalı kondanser
- Darbeye dayanıklı, gıda sınıfı polikarbonat kaseler
- Paslanmaz çelik yapı

- Designed to make and dispense granitas & iced drinks
- Magnetic system stirrer
- Excl. patented magnetic transmission system
- Easy to use and versatile
- Quick and easy cleaning
- Hermetic compressor
- Air cooled condenser
- Shockproof polycarbonate food grade bowls
- S/S structure



### Minigel

#### » Dondurma Makinesi

Granita & Ice Slush Dispenser

218

Kod Code	Kapasite (lt) Capacity (lt)	Ölçü (cm) Dim. (cm)
59040006	6	19,5x48x61,5

- Darbeye dayanıklı, toksik olmayan kopolyester hazne
- Boyanmış çelik gövde
- İki hermetik kompresör
- Hava soğutmalı kondanser
- Aşırı yük koruyucu
- Kondanser filtresi
- Gürültü seviyesi 70 dB altında

- Shock proof, non toxic copolyester container
- Painted steel body
- Two hermetic compressor
- Air - cooled condenser
- Overload protector
- Condenser filter
- Noise level lower than 70 dB



### ICON 1

#### » Buzlu İçecek Makinesi / Ice Slush

Ice Slush Dispenser

Kod Code	Kapasite (lt) Capacity (lt)	Ölçü (cm) Dim. (cm)
59040003	2,8	18x49x44

**NEW**



» Blender Kare Hazneli  
Blender Square Jug

Kod  
Code  
63010040



» Blender (Ses Geçirmez Hazneli)  
Blender (w/Sound Enclosure)

Kod  
Code  
63020015

NEW



**SOUSCHEF**  
» Blender Kare Hazneli  
Blender Square Jug

Kod  
Code  
64020011

NEW



**SOUSCHEF**  
» Blender (Ses Geçirmez Hazneli)  
Blender (w/Sound Enclosure)

Kod  
Code  
64020012



» Blender Yuvarlak Hazneli  
Blender Round Jug

Kod  
Code  
63010014



» Blender (Ses Geçirmez Hazneli)  
Blender (w/Sound Enclosure)

Kod  
Code  
63010041



» Blender  
Blender

Kod  
Code  
63010013



» İçecek Mikseri  
Beverage Mixer

Kod  
Code  
63010011



» Narenciye Sıkacağı  
Citrus Juicer

Kod Code	Model Model
63010016	Kapaklız / w/o Lid
63010017	Kapaklı / w/Lid



» Portakal/Nar Sıkma  
Orange/Pomegranate Juicer

Kod Code	Model Model	Koli/Adet Pcs/Ctn
41030002	Portakal/ Orange	1
41030012	Portakal & Nar / Orange & Pomegranate	1



» Çay Otomatı  
Tea Maker

Kod Code	Model Model	Kapasite (lt) Capacity (lt)
41011090	80 Bardak/Glasses	9
41011120	120 Bardak/Glasses	12
41011160	160 Bardak/Glasses	16
41011250	250 Bardak/Glasses	22
41101450	400 Bardak/Glasses	38



» Buz Kırıcı  
Ice Crusher

Kod Code
63010039



» Buz Kırıcı  
Ice Crusher

Kod Code
63010018



» Buz Makinesi 25  
Ice Machine 25

Kod Code	Kapasite (kg/24s) Capacity (kg/24s)	Ölçü (mm) Dim (mm)
72010025	22	355x404x590



Gurme Buz  
Gourmet Ice  
Ice Code: SI  
18 gr



Buz Tipi / Ice Type  
Soğutma Sistemi / Cooling System  
İklim Sınıfı / Climate Class  
Soğutucu Gaz / Refrigerant Gas  
Voltaj / Voltage

Gurme/Gourmet  
Air  
T  
R290  
230V-50Hz



» Buz Makinesi  
Ice Machine

Kod Code	Kapasite (kg/24s) Capacity (kg/24s)	Ölçü (mm) Dim (mm)
72010035	32	500x580x690
72010050	47	500x580x800

Gurme Buz  
Gourmet Ice  
Ice Code: SI  
18 gr



Buz Tipi / Ice Type  
Soğutma Sistemi / Cooling System  
İklim Sınıfı / Climate Class  
Soğutucu Gaz / Refrigerant Gas  
Voltaj / Voltage

Gurme/Gourmet  
Air  
T  
R290  
230V-50Hz



» Buz Makinesi Fındık  
Ice Machine Nugget

Kod Code	Kapasite (kg/24s) Capacity (kg/24s)	Ölçü (mm) Dim (mm)
72010080	80	500x670x800



Fındık Buz  
Nugget Ice  
Ice Code: NI



Buz Tipi / Ice Type  
Soğutma Sistemi / Cooling System  
İklim Sınıfı / Climate Class  
Soğutucu Gaz / Refrigerant Gas  
Voltaj / Voltage

Fındık Buz/Nugdet Ice  
Air  
T  
R290  
230V-50Hz



» Buz Makinesi  
Ice Machine

Kod Code	Kapasite (kg/24s) Capacity (kg/24s)	Ölçü (mm) Dim (mm)
72010250	230	761x622x576
72010500	440	761x622x726

Tam Meşrubat Buz  
Full Dice Ice  
Ice Code: FDI  
12 gr

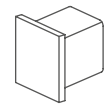

Buz Tipi / Ice Type  
Soğutma Sistemi / Cooling System  
İklim Sınıfı / Climate Class  
Soğutucu Gaz / Refrigerant Gas  
Voltaj / Voltage

Tam Meşrubat Buzu/Full Dice Ice  
Air  
T  
R290  
230V-50Hz



» Vega İçecek Dispenseri  
Vega Juice Dispenser

Kod Code	Lt Lt	Koli/Adet Pcs/Ctn
55011412	12	1



» Vega Kahve Dispenseri  
Vega Coffee Dispenser

Kod Code	Lt Lt	Koli/Adet Pcs/Ctn
55011312	12	1



» Carina İçecek Dispenseri  
Carina Juice Dispenser

Kod Code	Lt Lt	Koli/Adet Pcs/Ctn
55011277	7,7	1
55011278	2x7,7	1
55011279	3x7,7	1

222



» Lux İçecek Dispenseri  
Lux Juice Dispenser

Kod Code	Lt Lt	Koli/Adet Pcs/Ctn
54012112	12	1



» Lux Kahve Dispenseri  
Lux Coffee Dispenser

Kod Code	Lt Lt	Koli/Adet Pcs/Ctn
54012212	12	1



» Meyve Suyu Dispenseri  
Juice Dispenser

Kod Code	Ölçü (cm) Dim. (cm)	Lt Lt	Koli/Adet Pcs/Ctn
59039021	37x23x60	7	1
59039022	37x45x69	14	1



» Premium İçecek Dispenseri  
Premium Juice Dispenser

Kod Code	Lt Lt	Koli/Adet Pcs/Ctn
54011112	12	1

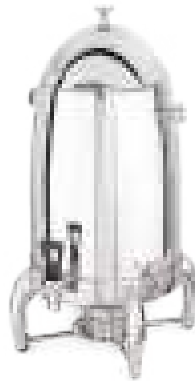

» Premium Kahve Dispenseri  
Premium Coffee Dispenser

Kod Code	Lt Lt	Koli/Adet Pcs/Ctn
59011019	19	1



» Lux Süt Dispenseri  
Lux Milk Can

Kod Code	Lt Lt	Koli/Adet Pcs/Ctn
54011212	6	1

• Kendinden buz hazneli kapak  
• Lid has self ice store



» Lux Termos (Switch Kapak)  
Beverage Server S/S Insulated

Kod Code	Kapasite (lt) Capacity (lt)	Koli/Adet Pcs/Ctn
51019210	1,00	6
51019215	1,50	6
51019220	2,00	6



» Termos (İç-Dış S/S)  
Beverage Server S/S Insulated

Kod Code	Kapasite (lt) Capacity (lt)	Koli/Adet Pcs/Ctn
51021310	1,00	6
51021315	1,50	6
51021320	2,00	6

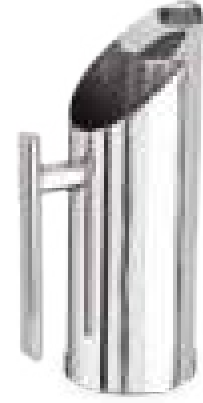

» Sürahi  
Water Jug

Kod Code	Ölçü (cm) Dim. (cm)	Koli/Adet Pcs/Ctn
60011431	Ø 85x26	6



» French Press  
French Press

Kod Code	ml ml	Koli/Adet Pcs/Ctn
58060350	350	6
58060600	600	6



» PC Sürahi  
PC Jug

Kod Code	Kapasite (lt) Capacity (lt)	Koli/Adet Pcs/Ctn
60020018	1,8 Lt	6



» Süt Potu  
Milk Pot

Kod Code	Model Model	Kapasite (lt) Capacity (lt)	Koli/Adet Pcs/Ctn
62010150	Süt Potu / Milk Pot	150 ml	6



» Mini Tabak  
Mini Tea Bag Plate

Kod Code	Model Model	Koli/Adet Pcs/Ctn
40202250	Mini Tabak Mini Tea Bag Plate	1



» Bardak  
Mug S/S

Kod Code	Koli/Adet Pcs/Ctn
36702052	12

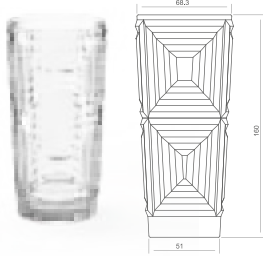

» Bardak  
Glass

Kod Code	ml ml	Ad./Koli Pcs/Ctn
45000350	350	6



» Şarap Bardağı  
Wine Glass

Kod Code	ml ml	Ad./Koli Pcs/Ctn
45010350	350	6

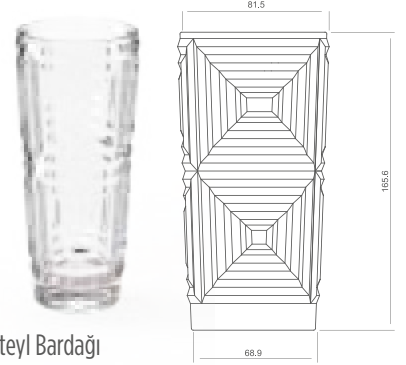

» Kokteyl Bardağı  
Cocktail Glass

Kod Code	ml ml	Ad./Koli Pcs/Ctn
45000600	600	6

224

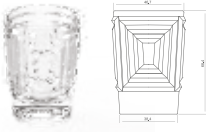

» Shot Bardağı  
Shot Glass

Kod Code	ml ml	Ad./Koli Pcs/Ctn
45000060	60	6

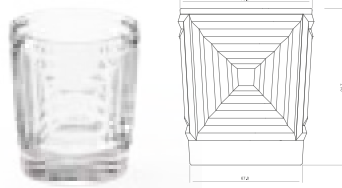

» Viski Bardağı  
Whiskey Glass

Kod Code	ml ml	Ad./Koli Pcs/Ctn
45000300	300	6



» Bardak  
Glass

Kod Code	ml ml	Ad./Koli Pcs/Ctn
44000350	350	6



» Şarap Bardağı  
Wine Glass

Kod Code	ml ml	Ad./Koli Pcs/Ctn
44010350	350	6



» Kokteyl Bardağı  
Cocktail Glass

Kod Code	ml ml	Ad./Koli Pcs/Ctn
44000600	600	6



» Viski Bardağı  
Whiskey Glass

Kod Code	ml ml	Ad./Koli Pcs/Ctn
44000300	300	6

\* 2000 adet ve üzerinde renk opsiyonları mevcuttur (kırmızı,sarı,mavi,yeşil,mor,siyah)

\* Color options are available for quantities of 2,000 or more (red, yellow, blue, green, purple, black)

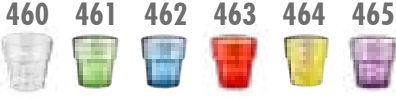

» Bardak  
Glass

Kod Code	ml ml	Ad./Koli Pcs/Ctn
46010250	250	50
46010300	300	50
46010400	400	50



» Kumlu Bardak  
Sandy Surface Glass

Kod Code	ml ml	Ad./Koli Pcs/Ctn
46011250	250	400
46011400	400	400



» Prizma/Shot Bardak  
Prisma/Shot Glass

Kod Code	ml ml	Model Model	Ad./Koli Pcs/Ctn
46013250	250	Prizma / Prisma	50
46010060	60	Shot / Shot	245

Rakı Bardağı  
Juice Glass



Viski Bardağı  
Whiskey Glass



» Rakı/Viski Bardağı  
Juice/Whiskey Glass

Kod Code	Model Model	ml ml	Ad./Koli Pcs/Ctn
46010240	Rakı/Juice	240	50
46012250	Viski/Whiskey	250	50

Kokteyl Bardağı  
Cocktail Glass



Ayaklı Bardağı  
Goblet Glass



» Ayaklı/Kokteyl Bardak  
Goblet/Cocktail Glass

Kod Code	Model Model	ml ml	Ad./Koli Pcs/Ctn
46010295	Ayaklı/Goblet	295	50
46010320	Kokteyl/Cocktail	320	50

Şarap Bardağı  
Wine Glass



Goblet Bardağı  
Goblet Glass



» Şarap Kadehi/Goblet Bardak  
Wine/Goblet Glass

Kod Code	Model Model	ml ml	Ad./Koli Pcs/Ctn
46014250	Kadeh/Wine	250	50
46013400	Goblet/Goblet	400	50

Ayran-Bira Bardağı  
Beer Glass



Tulip Glass



» Ayran-Bira/Tulip Bardak  
Beer/Tulip Glass

Kod Code	Model Model	ml ml	Ad./Koli Pcs/Ctn
46010500	Ayran-Bira/Beer	500	24
46012400	Tulip/Tulip	400	100

460 461



» Çay-Kahve Kupası  
Mug

Kod Code	ml ml	Ad./Koli Pcs/Ctn
46015250	250	50
46015300	300	50

460 461 462 463



» Kahve Kupası  
Mug

Kod Code	ml ml	Ad./Koli Pcs/Ctn
46010280	280	24

\* Adet sağlanırsa tüm bardaklara logo ve yazı baskısı yapılabilir.

\* Logo printing is possible for certain MOQ

\* Tüm bardaklar koli bazında satılır.

Bar



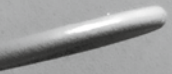
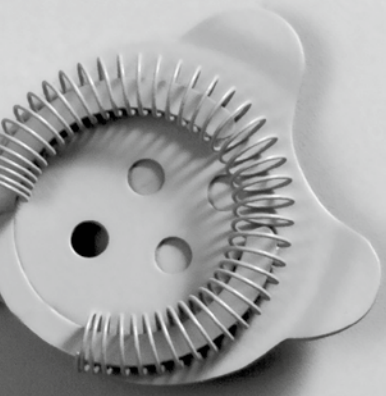



» Buz Kovası (Çift Cidarlı)  
Ice Bucket (D/W)

Kod Code	Ölçü (cm) Dim. (cm)	Koli/Adet Pcs/Ctn
60016118	Ø15,5x16,5	6



» Buz Kovası Halka Saplı Termoslu  
Round Handled Ice Bucket

Kod Code	Model Model	Ø (cm) Ø (cm)	Koli/Adet Pcs/Ctn
91000011	Kapaklı/w/Lid	15,5	6
91000012	Kapaklı&Tabaklı w/Lid-Plate	15,5	6



» Buz Kovası Ay Saplı Termoslu  
Crescent Handled Ice Bucket

Kod Code	Model Model	Ø (cm) Ø (cm)	Koli/Adet Pcs/Ctn
91000016	Kapaklı/w/Lid	15,4	6
91000015	Kapaklı&Tabaklı w/Lid-Plate	15,4	6



» Halka Saplı Şampanya Kova  
Champagne/Wine Bucket

Kod Code	Ölçü (cm) Dim. (cm)	Koli/Adet Pcs/Ctn
36752221	Ø 21x22	6



» Şampanya/Şarap Kova (Mat)  
Champagne/Wine Bucket (Satin)

Kod Code	Ölçü (cm) Dim. (cm)	Koli/Adet Pcs/Ctn
60016105	19x21	6



» Buz Kovası Halka Saplı Siyah  
Round Handled Ice Bucket

Kod Code	Ölçü Ø (cm) Dim Ø(cm)	Koli/Adet Pcs/Ctn
36305019	15,5	1

NEW



» Şarap Kovası Masa Standı (Çelik)  
Wine Bucket Table Stand

Kod Code	Ölçü (cm) Dim. (cm)	Koli/Adet Pcs/Ctn
60010244	50x19x16	6

\* Şarap kovası fiyata dahil değildir.  
\* w/o Bucket

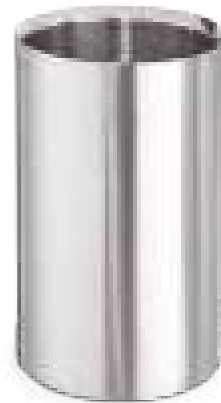

» Mat Şişe Soğutucu  
D/W Satin Bottle Cooler

Kod Code	Ölçü (mm) Dim. (mm)	Koli/Adet Pcs/Ctn
60016106	Ø12x20	6

\* Çift cidarlıdır.  
\* Double Wall





» Ölçü Kabı Cam  
Mixing Glass

Kod Code	Koli/Adet Pcs/Ctn
60020008	6



» Klasik Shaker  
Cocktail Shaker

Kod Code	ml ml	Koli/Adet Pcs/Ctn
60010350	300	6
60010500	500	6
60010750	750	6



» Boston Shaker S/S  
Boston Shaker S/S

Kod Code	Koli/Adet Pcs/Ctn
60020007	6

\* Ölçü kabı fiyata dahil değildir.  
\* w/o Mixing Glass



» Punch Kasesi  
Punch Bowl

Kod Code	Ölçü (cm) Dim. (cm)	Koli/Adet Pcs/Ctn
35053626	Ø 36x26	1



» Eğimli Punch Kasesi  
Angled Punch Bowl

Kod Code	Ölçü (cm) Dim. (cm)	Koli/Adet Pcs/Ctn
35053625	Ø 36x26	1



» Punch Kasesi  
Punch Bowl

Kod Code	Ölçü (cm) Dim. (cm)	Koli/Adet Pcs/Ctn
60010530	Ø 43x22,5	1

230



» Şampanya Kova Standı  
Champagne Bucket Stand

Kod Code	Ölçü (cm) Dim. (cm)	Koli/Adet Pcs/Ctn
37752222	65	1





» Kaydırmaz Açacak  
Non-slip Bottle Opener

Kod Code	Ölçü (cm) Dim. (cm)	Koli/Adet Pcs/Ctn
83010047	18 cm	6



» Garson Çakısı  
Waiter's Corkscrew

Kod Code	Koli/Adet Pcs/Ctn
83010045	6



» Tirbuşon  
Winged Corkscrew

Kod Code	Koli/Adet Pcs/Ctn
83010046	6



» Bar Konteynır  
PC Bar Container

Kod Code	Model Model	Koli/Adet Pcs/Ctn
60020004	4 Bölme / 4 Compartment	6
60020005	5 Bölme / 5 Compartment	6
60020006	6 Bölme / 6 Compartment	6



» Bar Süzgeci  
Bar Strainer

Kod Code	Koli/Adet Pcs/Ctn
62016137	6

231



» Kadeh Tatlandırıcı  
Chalice Sweetener

Kod Code	Koli/Adet Pcs/Ctn
60020009	6



» Pepet/Pecetelik  
Napkin/Pipette Holder

Kod Code	Koli/Adet Pcs/Ctn
60020012	4



» Bar Matı  
Service / Bar Mat

Kod Code	Ölçü (cm) Dim. (cm)	Koli/Adet Pcs/Ctn
62015980	60x80x1,7	4



**NEW**

» Soda Sifonu  
Soda Siphon

Kod Code	Kapasite Capacity	Koli/Adet Pcs/Ctn
43130048	1,0 Lt	1
43130049	10x8 gr Soda Tüpü 10x8 gr Soda Charger	1

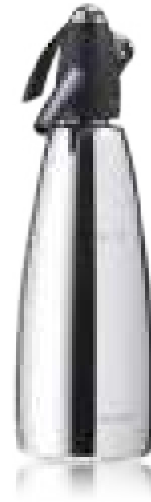

\* 1 soda tüpü ile 1 litreye kadar soda hazırlanabilir.  
\* One soda charger will prepare up to 1 litre of soda water.

232



» Soda Sifonu  
Soda Siphon

Kod Code	Kapasite Capacity	Koli/Adet Pcs/Ctn
43130045	1,0 Lt	1
43130047	10x8 gr Soda Tüpü 10x8 gr Soda Charger	1

\* 1 soda tüpü ile 1 litreye kadar soda hazırlanabilir.  
\* One soda charger will prepare up to 1 litre of soda water.



» Mojito Tokmağı  
Ice Crusher (Mojito)

Kod Code	Koli/Adet Pcs/Ctn
62010031	6



» Bar Kaşığı Dövme Uçlu Twist Saplı  
Bar Spoon/Masher (Full Twist)

Kod Code	Ölçü (cm) Dim. (cm)	Koli/Adet Pcs/Ctn
56036222	22	6



» Jigger  
Jigger

Kod Code	Kapasite Capacity	Ölçü (cm) Dim. (cm)	Koli/Adet Pcs/Ctn
60016120	2/4 cc	Ø 45x10	6



» Akıtıcı  
Pourer S/S

Kod Code	Koli/Adet Pcs/Ctn
62010033	6



» Akıtıcı (PVC)  
Pourer (PVC)

Kod Code	Koli/Adet Pcs/Ctn
62010333	6



» Üçlü Çerezlik  
Triple Nuts Display

Kod Code	Ölçü (cm) Dim. (cm)	Koli/Adet Pcs/Ctn
39311000	6,5	1
39311001	8	1
39311002	9	1
40310013	10	1



» Bölmeli Sosluk/Çerezlik  
Partitioned Nuts Bowl

Kod Code	Model Model	Ölçü (cm) Dim. (cm)	Koli/Adet Pcs/Ctn
80010195	2 Bölmeli / 2 Partitioned	10x17,5x2,5	12
80010196	3 Bölmeli / 3 Partitioned	10x26x2,7	12
80010197	4 Bölmeli / 4 Partitioned	10x33x2,5	12



» Ahşap Desenli Çerezlik  
Wooden Patterned Snack Bowl

Kod Code	Ölçü (cm) Dim. (cm)	Koli/Adet Pcs/Ctn
69021003	10x3,5	12

233



» 2 Bölmeli Dikdörtgen Çerezlik  
2 Part. Rectangular Nuts Bowl

Kod Code	Ölçü (cm) Dim. (cm)	Koli/Adet Pcs/Ctn
80010001	13x24x4	24



» 2 Bölmeli Yuvarlak Çerezlik  
2 Partitioned Round Nuts Bowl

Kod Code	Ölçü (cm) Dim. (cm)	Koli/Adet Pcs/Ctn
80010002	10x20x5,5	36



» 3 Bölmeli Oval Çerezlik  
3 Partitioned Oval Nuts Bowl

Kod Code	Ölçü (cm) Dim. (cm)	Koli/Adet Pcs/Ctn
80010003	16,5x24x4	24



» 3 Bölmeli Yuvarlak Çerezlik  
3 Partitioned Round Nuts Bowl

Kod Code	Ölçü (cm) Dim. (cm)	Koli/Adet Pcs/Ctn
80010004	25,5x25,5x3	24



» Maun Dikdörtgen Tepsi  
Wooden Rectangular Tray

Kod Code	Ölçü (cm) Dim. (cm)	Koli/Adet Pcs/Ctn
68012738	27x38	1
68013244	32x44	1
68013646	36x46	1
68013753	37x53	1
68014361	43x61	1



» Kırçılı Tepsi  
Textured Tray

Kod Code	Ölçü (cm) Dim. (cm)	Koli/Adet Pcs/Ctn
46612736	27x36	1
46613244	32x44	1
46613646	36x46	1
46613748	37x48	1
46613753	37x53	1



234



» Fiber Kaydırmaz Yuvarlak Tepsi  
Fiber Non-slip Round Tray

Kod Code	Ø (cm) Ø (cm)	Koli/Adet Pcs/Ctn
68210035	35,5	1
68210040	40,6	1
68210045	45	1



» Maun Kaydırmaz Yuvarlak Tepsi  
Wooden Non-slip Round Tray

Kod Code	Ø (cm) Ø (cm)	Koli/Adet Pcs/Ctn
68110033	33	1
68110038	38	1
68110043	43	1



» Maun Yuvarlak Tepsi  
Wooden Round Tray

Kod Code	Ø (cm) Ø (cm)	Koli/Adet Pcs/Ctn
68010033	33	1
68010038	38	1
68010043	43	1



» Fiber Kaydırmaz Dikdörtgen Tepsi  
Fiber Non-slip Rectangular Tray

Kod Code	Ölçü (cm) Dim. (cm)	Koli/Adet Pcs/Ctn
68213040	30x40	1
68213753	37x53	1
68214565	45x65	1
68215668	56x680(Oval)	1



» Maun Kaydırmaz Dikdörtgen Tepsi  
Wooden Non-slip Rectangular Tray

Kod Code	Ölçü (cm) Dim. (cm)	Koli/Adet Pcs/Ctn
68112738	27x38	1
68113244	32x44	1
68113646	36x46	1
68113753	37x53	1
68114361	43x61	1



» Ecoform Kaydırmaz Tepsi  
Ecoform Non-slip Rectangular Tray

Kod Code	Ölçü (cm) Dim. (cm)	Koli/Adet Pcs/Ctn
68413753	37x53	1

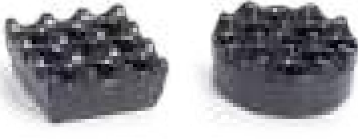

» Döküm  
Casted Black Ashtray

Kod Code	Model Model	Ölçü (cm) Dim. (cm)	Koli/Adet Pcs/Ctn
43040004	Kare/Square	8x8x3,5	6
43040005	Yuvarlak/Round	Ø 9,3x4	6



» Döküm  
Casted Ashtray

Kod Code	Model Model	Ölçü (cm) Dim. (cm)	Koli/Adet Pcs/Ctn
40350013	Kare/Square	8x8x3,5	6
43040001	Yuvarlak/Round	Ø 9,3x4	6



» Döküm Bronz  
Casted Bronze Ashtray

Kod Code	Model Model	Ölçü (cm) Dim. (cm)	Koli/Adet Pcs/Ctn
43040002	Kare/Square	8x8x3,5	6
43040003	Yuvarlak/Round	Ø 9,3x4	6



» Havuzlu  
Ashtray w/Cover

Kod Code	Model Model	Koli/Adet Pcs/Ctn
35930000	Kare/Square	6
35940000	Yuvarlak/Round	6



» Pirinç  
Brass Ashtray

Kod Code	Model Model	Ölçü (cm) Dim. (cm)	Koli/Adet Pcs/Ctn
43040006	Kare/Square	8x8x3,5	6
43040007	Yuvarlak/Round	Ø 9,3x4	6



» Havuzlu Rüzgarlıkl  
Wind Protected Ashtray

Kod Code	Model Model	Koli/Adet Pcs/Ctn
43040011	Küçük/Small	10
43040010	Büyük/Big	10

235

» Ayaklı Küllük Stand  
Ashtray Stand

Kod Code	h (cm) h (cm)	Koli/Adet Pcs/Ctn
40010004	76	1



» Puro Küllüğü  
Cigar Ashtray

Kod Code	Ölçü (cm) Dim (cm)	Koli/Adet Pcs/Ctn
93000003	16,5x8x3	1



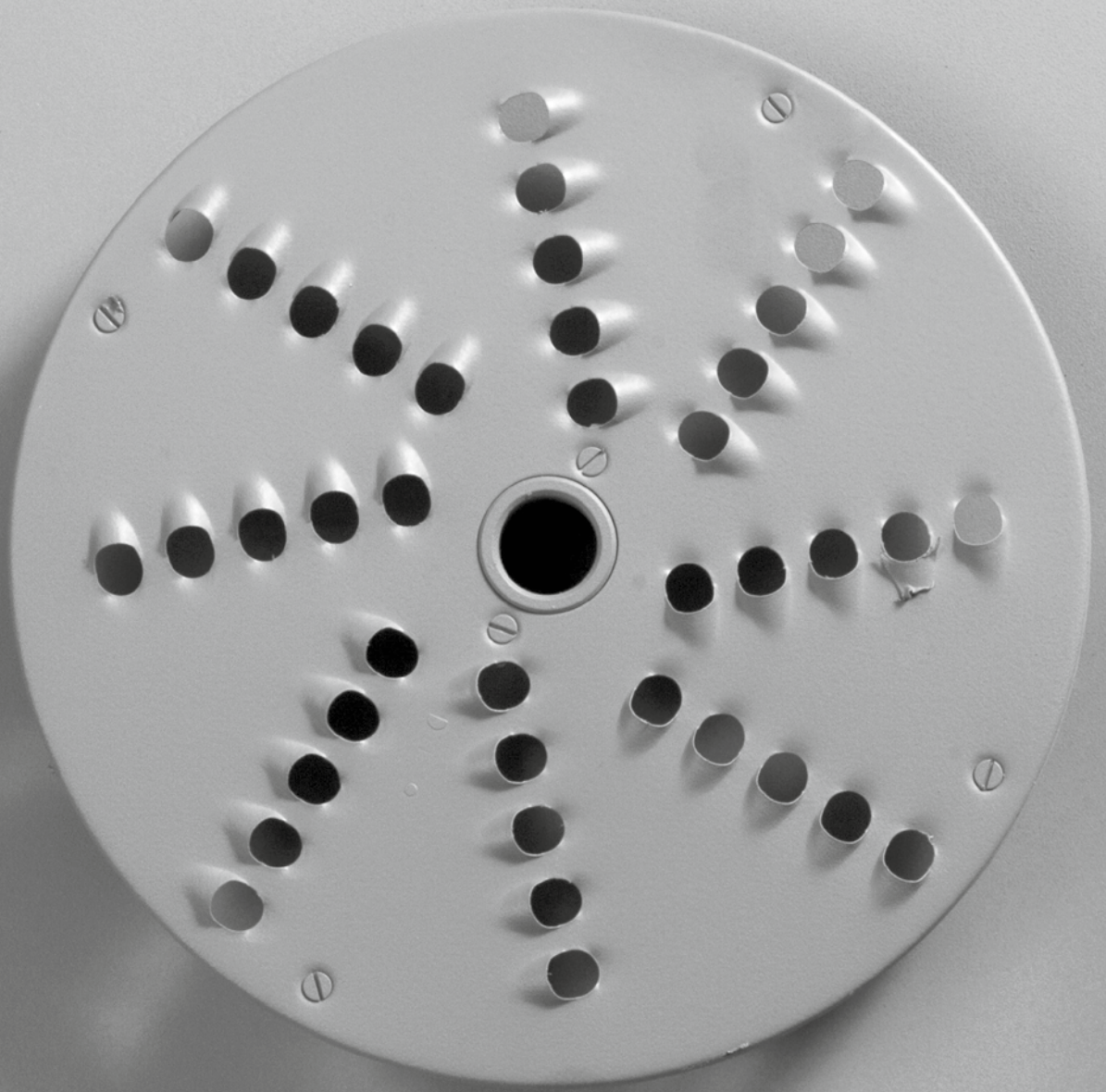

**Ekipmanlar**/Kitchen Appliances



- Rowzer Plus, kullanıcının ihtiyaç duyduğu 1 ila 10 arasındaki seçilebilir dozları işler, kalanları çözmeden bırakır.
- Cihazla birlikte verilen 1 L kapasiteli kaplarda -22°C (-76°F) sıcaklıkta 24 saat boyunca 800 gr'a kadar ürünü dondurur.
- En kolay kullanım için tasarlanmıştır, yalnızca istediğiniz doz miktarını seçmeniz yeterlidir, maksimum on doza kadar.
- 1000W profesyonel fırçasız motor, daha hızlı ve sessiz bir performans sağlar, en zorlu çalışma koşullarında bile uzun ömürlüdür.
- Güçlü ve hassas yardımcı motor.
- Bir adet aktif karbon hava filtresi.
- Kesintisiz çalışma: 1 ila 10 arasında istenen porsiyonları seçin.
- Rowzer Plus only processes the desired selectable doses that the user needs, from 1 to 10, without defrosting the remaining.
- Will freeze up to 800g of product in the 1 L capacity containers supplied with the appliance, frozen at a temperature of -22°C (-76°F) for 24 hours
- Designed for the easiest operation, you only need to select how many doses you want, up to ten.
- Professional Brushless Motor 1000W, gives a faster and silent performans, proven long life even with the hardest work conditions.
- Powerful and accurate auxiliar motor
- One active carbon air filter.
- Non stop working portion to portion: select desired portions from 1 to 10

## ROWZER

**NEW**

238

63020002



Aksesuar S/S Hazne  
 Accesorry Stainless Steel Jar

Güç / Power	220-240 V, 1000 W, 50/60 Hz
Kapasite / Capacity	1 L
Bıçak Hızı / Blade Speed	2000 rpm
Hava Basıncı / Air Pressure	1 Bar
Ölçüler / Dimensions	39,5 x 19 x, 47,5 cm

- \*10 porsiyon için işaretlenmiş, kapaklı 2 paslanmaz çelik kavanoz
- \*2 Stainless steel jars with lid, marked for 10 portions
- \*Sızdırmaz kapaklı kavanoz tutucu
- \*Jar holder with sealing lid

Kod Code	Model Model
63020001	Rowzer
63020002	S/S Hazne /Jar



- Profesyonel kullanım için tasarlanmıştır
- İndüksiyon teknolojisi enerji tüketimini azaltır, hızlı ısıtma, soğutma ve sıcaklık geri kazanımı sağlar
- 27°C ile 140°C arasında hassas sıcaklık kontrolü
- Yüksek sıcaklık modu 160°C
- Bisfenol içermeyen hazne
- Hız: 1 ile 20 arasında, ek olarak turbo hız fonksiyonu
- Yaklaşık 2.000 saatlik pişirme ömrü
- Sote, yoğurma ve turbo modları
- 90 dakikalık zamanlayıcı
- Made for Professional use
- Induction technology reduces the energy consumption, provides fast heating, cooling & temperature recovery
- 27°C to 140°C degree precision
- High temperature mode 160°C
- Bisphenol free jar
- Speed From 1 to 20 , additional turbo speed function
- 2.000H of cooking (approx.)
- Sauté, knead & turbo modes
- Timer 90 min

## Mycook PRO



NEW



239

» Kod  
Code  
64020010



Güç / Power	2000 W
Kapasite / Capacity	2,5 L
Motor / Engine	1.000 W - DC motor
Bıçak Hızı / Blade Speed	From 50 to 7.250 RPM
Ölçüler / Dimensions	38 x 30 x 29 cm



\*Bıçaklar bulaşık makinesi için uygun değildir \*Blades is not suitable for dishwasher

- İlk ve tek induksiyon teknolojisine sahip mutfak robotu
- "SOTE" fonksiyonuna sahip tek mutfak robotu
- Özel yoğurma fonksiyonu, her tür hamur, özellikle pizza hamuru yoğurma
- Ölçü kabı ve özel paslanmaz çelik bıçaklar
- Tüm parçalar kolayca temizlenebilir
- Uzun ömürlü kullanım için paslanmaz çelik kaplama
- Kolay görüntüleme için ergonomik olarak geriye doğru eğimli tasarım
- 800W gücünde profesyonel motor
- The first and only kitchen robot with induction technology
- The only kitchen robot with a "Sauté" function.
- Special kneading function for all types of dough, especially pizza dough.
- Measuring cup and special stainless steel blades.
- All parts are easy to clean.
- Stainless steel coating for long-lasting use.
- Ergonomic backward-tilted design for easy viewing.
- 800W professional motor.

# Mycook

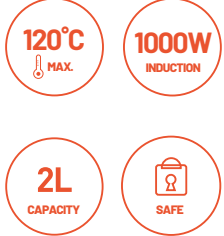

**NEW**

 » Kod  
 Code  
 64020005

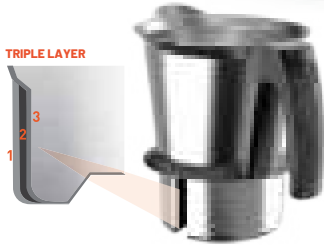
240

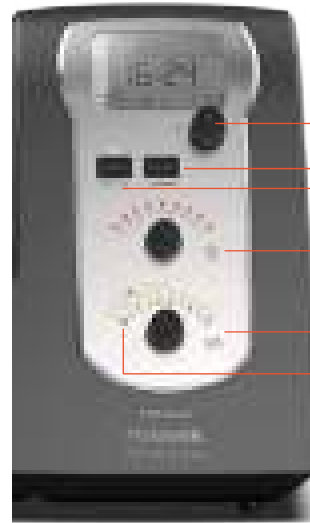

Güç / Power	1800 W
Kapasite / Capacity	2 L
Motor / Engine	800 W
Isıtma / Heating	1000 W
Motor / Engine	800 W

 DİJİTAL EKREN  
 FONKSİYONU: GÖSTERGE  
 ALARMLARI VE HATA  
 KODLARI

 DIGITAL DISPLAY  
 FUNCTION INDICATOR  
 ALARMS AND ERROR  
 CODES

 ZAMANLAYICI  
 TIMER

TURBO FONKSİYONU / TURBO FUNCTION

 YOĞURMA FONKSİYONU  
 KNEADING FUNCTION

 SICAKLIK: 40°C'DEN 120°C'YE KADAR  
 TEMPERATURE FROM 40° UP TO 120°C

 10 HIZ SEVİYESİ  
 10 SPEEDS

 SOTELEME FONKSİYONU  
 SAUTÉ FUNCTION

 Standart Mycook 1.8 ile SPATULA ve KARIŞTIRMA PALETİ dahildir.  
 SPATULA and MIXING PADDLE included in the standard Mycook 1.8

Soslar, çorbalar, aromalı soslar, hamur işleri, çikolata temperleme vb.

Sauces, soups, flavored sauces, pastry dough, chocolate tempering, etc.



- 1 HP, ağır hizmet tipi motor
- 750W BLDC motor - hız aralığı 3.000 - 20.000 rpm
- Hız kontrol düğmesi ile ayarlanabilir hız
- Geniş giriş voltaj aralığı: 110 - 240 VAC & 50/60 Hz (çıkış gücünü etkilemeden)
- Çok amaçlı paslanmaz çelik bıçak
- BLDC çalışma prensibi sayesinde yüksek verimlilik
- Düşük ısı yayılımı, uzun süreli sürekli çalışmayı destekler
- Hız arttıkça tork gücünün sabit kalması (evrensel veya fırçalı DC motor kullanan çoğu blenderda bu düşüş yaşanır)
- Fırçasız çalışma brushless motor sayesinde dayanıklılık ve uzun ömür (komütatör aşınması yoktur)
- Kolay ve konforlu kullanım için ergonomik tasarım
- Tamamen kapalı paslanmaz çelik şaft, kolayca çıkarılabilir ve bulaşık makinesinde yıkanabilir
- Koruma ve güç düğmesi ile çalışır, kazara açılmayı önler
- Kolay kullanım için kilitleme düğmesi ile çalışır

- 1 HP, heavy-duty motor
- 750W BLDC motor - speed 3,000 - 20,000 rpm
- With speed control knob
- Large input voltage range from 110 to 240
- VAC & 50/60 Hz without affecting output power
- All- purpose stainless steel blade
- High efficiency due to BLDC working principle
- Little heat dissipation which sustaining long time continuous operation
- Stable torque force which does not decrease as rotation speed increases (this happens in the most prevailing immersion blenders using universal or Brush DC motors)
- Durability and long life thanks to brushless motor operation (no commutator wear)
- Ergonomic design for easy and comfortable operation
- Completely sealed stainless steel shaft, easily removable and dishwasher safe
- Operating with Protection and Power button that avoid accidental switching ON
- Operating with Locking button for easy handling



Kod Code	Model Model
63010029	Blender Forte 750 / Blender Forte 750w
63010031	Şaft 38 cm / Shaft 38 cm
63010032	Şaft 45 cm / Shaft 45 cm
63010033	Şaft 53 cm / Shaft 53 cm
63010034	Çırpıcı / Whisk

241

63010029



El Tipi Blender  
Blender

63010033



Çırpıcı ve Saftlar  
Whisk and Shaft

### Brushless DC MOTOR

Brushless DC motorların Universal ve fırçalı DC motorlara göre en önemli avantajlarından biri, dönme hızı arttığında tork gücünün azalmamasıdır. Bu avantaj, blenderin sağladığı güçlü kuvvet sayesinde kullanıcıların çalışma sürelerini kısaltmalarını sağlar.

One of the most significant advantages of Brushless DC motors compared to Universal and Brush DC motors is that torque force does not decrease as rotational speed increases. This advantage allows users to shorten their operating time thanks to the strong force provided by the blender.

Güç / Power

750 W - 1000 W

Güç Kaynağı / Power Source

220 - 240V ~ 50Hz

Bıçak Deviri / Knives Revolutions

r.p.m. 3000 - 12000

Net Ağırlık / Net Weight

3,2 Kg

Ölçüler / Dimensions

A B C  
105 mm 100 mm 340 mm

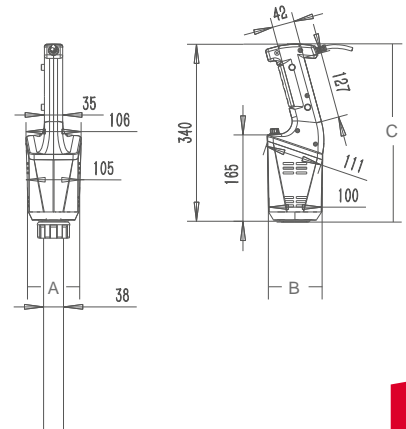

- Yüksek verimli patentli soğutma sistemli motor
- Sağlam ve hafif fiberglass ABS gövde
- Yüksek verimli motorlar
- 3 farklı hız kontrolü
- Matkap sistemli hız kontrolü
- Sabitlenebilir hız kontrolü
- Cihazın yanlışlıkla açılmasını önleyen güvenlik mekanizması
- Sürekli karıştırma için tetik sistemli mandal
- 3 farklı motor
- IPX3 su geçirmezlik koruması
- Pratik montaj mekanizması
- Daha uzun ömür ve doğru temizlik için tamamen ayrılabilir miler
- Efficient engine cooling system
- Sturdy, lightweight ABS frame Glass Filled
- Practical and ergonomic handle
- Powerful performance engines
- Fixed speed
- Variotronic: speed control with stabilizer
- Safety system against accidental ignition
- The Trigger switch
- Available in 3 different engines
- The machine is protected with IPX3
- Quick coupling system
- Totally removable rods for a thorough cleaning which extends their life

Soğutmalı Motor  
Ventilated Motor

» Kod  
Code

Model  
Model

63010042  
63010023  
63010008  
63010009  
63010024

El Tipi Blender / Blender  
Şaft 35 cm / Shaft 35 cm  
Şaft 45 cm / Shaft 45 cm  
Çırpıcı / Whisk  
Duvar Askısı / Wall Attachment

242

63010042

El Tipi Blender  
Blender

63010008

63010023

63010009

Çırpıcı ve Saftlar  
Whisk and Shaft

63010024

Duvar Askısı  
Wall Attachment

Güç / Power

750 W

Güç Kaynağı / Power Source

230 V/50 Hz

Bıçak Deviri / Knives Revolutions

r.p.m. 2000 - 11500

Çalışma Kapasitesi / Working Capacity

300 Lt

Net Ağırlık / Net Weight

3,9 Kg

Ölçüler / Dimensions

A	B	C
125 mm	190 mm	390 mm

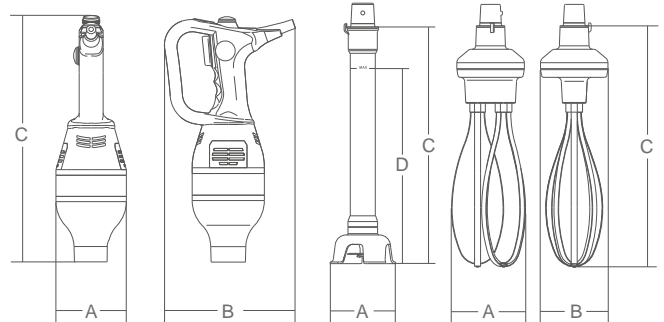

Made in Italy

- Yüksek verimli patentli soğutma sistemli motor
- Sağlam ve hafif fiberglass ABS gövde
- Yüksek verimli motorlar
- 3 farklı hız kontrolü
- Matkap sistemli hız kontrolü
- Sabitlenebilir hız kontrolü
- Cihazın yanlışlıkla açılmasını önleyen güvenlik mekanizması
- Sürekli karıştırma için tetik sistemli mandal
- 3 farklı motor
- IPX3 su geçirmezlik koruması
- Pratik montaj mekanizması
- Daha uzun ömür ve doğru temizlik için tamamen ayrılabilir miler
- Efficient engine cooling system
- Sturdy, lightweight ABS frame Glass Filled
- Practical and ergonomic handle
- Powerful performance engines
- Fixed speed
- Variotronic: speed control with stabilizer
- Safety system against accidental ignition
- The Trigger switch
- Available in 3 different engines
- The machine is protected with IPX3
- Quick coupling system
- Totally removable rods for a thorough cleaning which extends their life

 Soğutmalı Motor  
Ventilated Motor

Kod Code	Model Model
63010006	El Tipi Blender / Blender
63010023	Şaft 35 cm / Shaft 35 cm
63010008	Şaft 45 cm / Shaft 45 cm
63010009	Çırpıcı / Whisk
63010024	Duvar Askısı / Wall Attachment

243



63010006

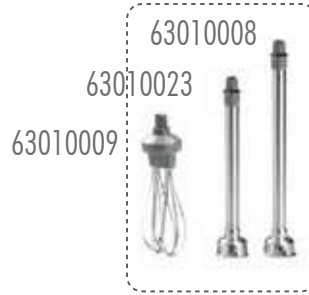

63010009



63010024

Güç / Power	550 W
Güç Kaynağı / Power Source	230 V/50 Hz
Bıçak Deviri / Knives Revolutions	r.p.m. 13.000
Çalışma Kapasitesi / Working Capacity	200 Lt
Net Ağırlık / Net Weight	3,5 Kg
Ölçüler / Dimensions	A B C 125 mm 190 mm 385 mm

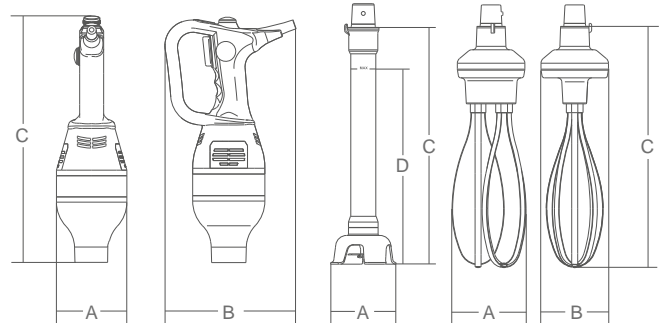



- Yüksek verimli patentli soğutma sistemli motor
- Sağlam ve hafif fiberglass ABS gövde
- Matkap sistemli hız kontrolü
- Sabitlenebilir hız kontrolü
- Cihazın yanlışlıkla açılmasını önleyen güvenlik mekanizması
- Sürekli karıştırma için tetik sistemli mandal
- IPX3 su geçirmezlik koruması
- Pratik montaj mekanizması
- Daha uzun ömür ve doğru temizlik için tamamen ayrılabilir miler
- Paslanmaz çelik mil ve kampana
- Efficient engine cooling system
- Sturdy, lightweight ABS frame Glass Filled
- Fixed and variable speed controls available
- Safety system against accidental ignition
- The Trigger switch
- The machine is protected with IPX3
- Quick coupling system
- Cutlery steel knives
- Whisk with metal gearing
- Whips Demountable and in the dishwasher

Sogutmalı Motor  
Ventilated Motor



Kod Code	Model Model
63010043	El Tipi Blender / Blender
63010044	Şaft 25 cm / Shaft 25 cm
63010045	Şaft 35 cm / Shaft 35 cm
63010046	Çırpıcı / Whisk
63010024	Duvar Askısı / Wall Attachment

63010043



El Tipi Blender  
Blender

63010045

63010044  
63010046



Çırpıcı ve Saftlar  
Whisk and Shaft

63010024



Duvar Askısı  
Wall Attachment

Güç / Power

360 W

Güç Kaynağı / Power Source

230 V/50 Hz

Bıçak Deviri / Knives Revolutions

r.p.m. 12.000

Çalışma Kapasitesi / Working Capacity

70 Lt

Net Ağırlık / Net Weight

2,5 Kg

Ölçüler / Dimensions

A B C  
100 mm 182 mm 348 mm

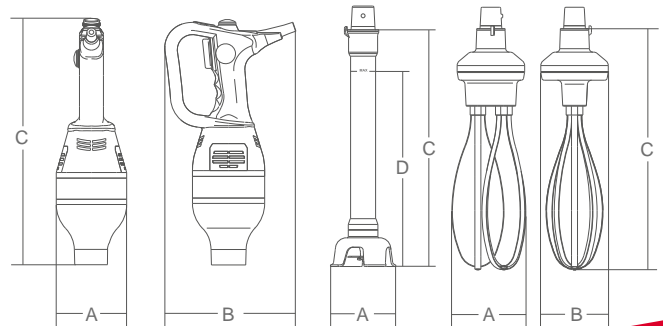

- Alüminyum alaşım ve paslanmaz çelik gövde
- Kesintisiz çalışma için soğutmalı motor
- Az yer kaplayan tasarımı sayesinde her mutfakta kolay kurulum
- Ayrıcalıklı besleme sistemi sayesinde yumuşak ürünleri işleme kolaylığı
- Besleme kolu, kapak ve toplama kabı arasındaki bağlantılı kilit sistemi sayesinde güvenli kullanım
- Her amaca uygun çok sayıda bıçak çeşidi (isteğe bağlı)

- Aluminium alloy and S/S construction.
- Ventilated motor for continuous operation.
- Thanks to its compact design the machine is easy to install inside every kitchen.
- The exclusive feeding system makes easy to process also soft products like moz-zarella cheese.
- Safe operation is ensured by interlock switches on product pusher, lid and collect-ing tray.
- Version with dishwashing safe S/S lid available
- Large number of discs available for every purpose



246



Disk Tutucu  
Disc Holder

Kod Code	Model Model
63010001	Sebze Doğrayıcı Vegetable Cutter
63010002	Disk Tutucu Disc Holder



Güç / Power

515 W

Güç Kaynağı / Power Source

230-400 V

Disk Deviri / Disc Revolutions

r.p.m. 300

Net Ağırlık / Net Weight

17,5 Kg

Ölçüler / Dimensions

A	B	C	D	E	G	H
225 mm	195 mm	255 mm	280 mm	510 mm	510 mm	770 mm

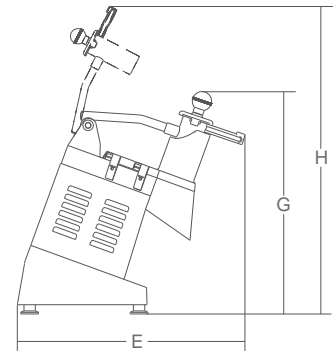
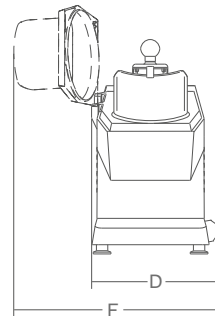
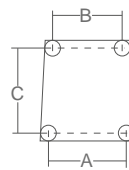



Dilimleyici Bıçaklar  
Slicer Discs

\* DF5 domates dilimleme için tavsiye edilir.  
\* DF5 is recommended for tomato slicing.

Kod Code	Kesme Kalınlığı (mm) Cutting Thickness (mm)
DF14	14
DF10	10
DF8	8
DF3	3
DF4	4
DF1	1
DF2	2
DF5*	5



Jülyen Dilimleyici Bıçaklar  
Jullien Slicer Discs

Kod Code	Kesme Kalınlığı (mm) Cutting Thickness (mm)
DQ10	10
DQ8	8
DQ6	6
DQ4	4

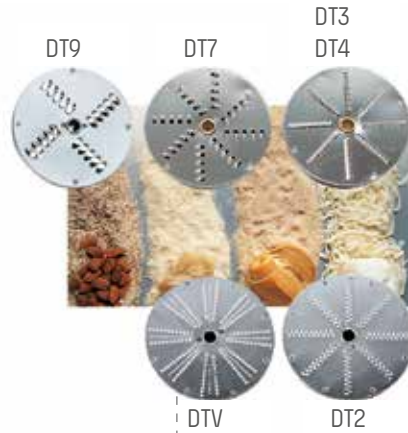

Rendeleyici ve Ufalayıcı Bıçaklar  
Grater and Granulator Discs

Kod Code	Kesme Kalınlığı (mm) Cutting Thickness (mm)
DT9	9
DT7	7
DT4	4
DT3	3
DT2	2
DTV	1



Küp Doğrayıcı Bıçaklar  
Dicer Discs

Kod Code	Kesme Kalınlığı (mm) Cutting Thickness (mm)
PS14	14
PS10	10
PS8	8

- Tamamen AISI 304 paslanmaz çelikten üretilmiştir.
- Güçlü, havalandırılmalı asenkron motor tarafından çalıştırılan bıçak.
- Sağlam, çıkarılabilir AISI 304 paslanmaz çelik hazne.
- Tritan malzemeden yapılmış yüksek dayanıklı paslanmaz çelik kapak.
- Temizlik ve hijyeni kolaylaştırmak için kolayca çıkarılabilir geçmeli kapak.
- IP 67 paslanmaz çelik butonlara sahip kontrol paneli.
- 3 bıçaklı standart yapıdaki kolayca çıkarılabilir bıçak göbeği (2 bıçak olarak yapılandırılabilir).
- Özel amaçlar için özel bıçaklar mevcuttur.
- Şaft üzerinde sıvı sızmasına karşı maksimum koruma.
- Et, balık ve sebzeler için mükemmel, ayrıca birçok farklı işleme de uygun.
- Manufactured entirely from AISI 304 stainless steel.
- Blade operated by a powerful, ventilated asynchronous motor.
- Durable, removable AISI 304 stainless steel bowl.
- Stainless steel lid made from Tritan material with high durability.
- Removable snap-on lid for easy cleaning and hygiene.
- Control panel with IP 67 stainless steel buttons.
- Easily removable blade hub with a standard 3-blade design (can be configured as 2 blades).
- Special blades available for specific purposes.
- Maximum protection against liquid leakage on the shaft.
- Ideal for meat, fish, and vegetables, also suitable for various other processes.



248

Kod Code	Model Model
63040008	Yatay Doğrama Makinesi / Horizontal Cutter
63042008	Dişli Bıçak / Serrated Knife
63052008	Düzleştirilmiş Bıçak / Smooth Edge



Standart bıçak  
Standard knife

63042008



Dişli Bıçak  
Serrated Knife

63052008



Düzleştirilmiş Bıçak  
Smooth Edge

Güç / Power	1500 W
Güç Kaynağı / Power Source	1 ph / 3 ph
Devir / Revolutions	r.p.m. 1440
Kapasite / Capacity	12 Lt
Net Ağırlık / Net Weight	75 Kg
Ölçüler / Dimensions	E F L 587 mm 902 mm 443 mm

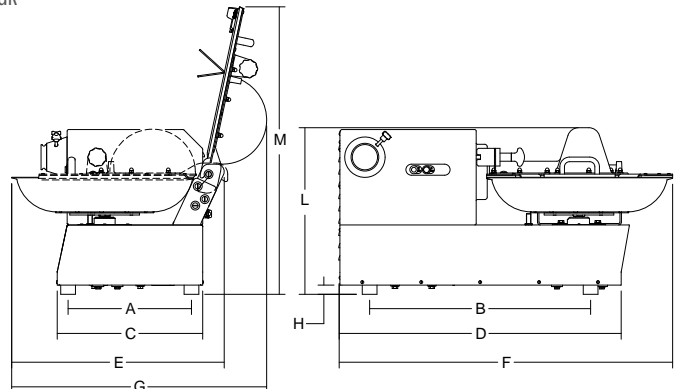

- Motor ve tank yan yana yerleştirilmiştir, böylece ürün ısıdan izole edilir.
- Saplı ve ağır tabanlı paslanmaz çelik hazne.
- Sürekli çalışma için yüksek verimli, havalandırılmalı motor.
- Güçlü çatal bıçak çeliğinden yapılmış bıçaklar.
- Kapakta güvenlik mikro anahtarı.
- Koldaki mikro anahtar.
- İşlem sırasında mükemmel görünürlük sağlayan şeffaf Tritan kapağı.
- İşlem sırasında malzeme eklemek için açılabilir kapak.
- Tank ve kapağın temizlenmesi için kazıyıcı spatula.

- The motor and tank are placed side by side, isolating the product from heat.
- Stainless steel bowl with handles and heavy bottom.
- High-efficiency ventilated motor for continuous operation.
- Strong knives made from cutlery steel.
- Safety micro-switch on the lid.
- Micro-switch on the lever.
- Transparent Tritan lid providing excellent visibility during processing.
- Lid with an opening to add ingredients during operation.
- Scraper spatula for cleaning the tank and lid.

**NEW**

» Sebze Doğrayıcı C-Tronic  
Vegetable Cutter C-Tronic

Kod Code	Koli/Adet Pcs/Ctn
63040009	1

249

Güç / Power	600 W - Hp 0,8
Devir / Revolutions	pm 600 ÷ 2.800
Kapasite / Capacity	3,5 Lt
Net Ağırlık / Net Weight	13.5 Kg
Ölçüler / Dimensions	E      D      F 296 mm 457 mm 300

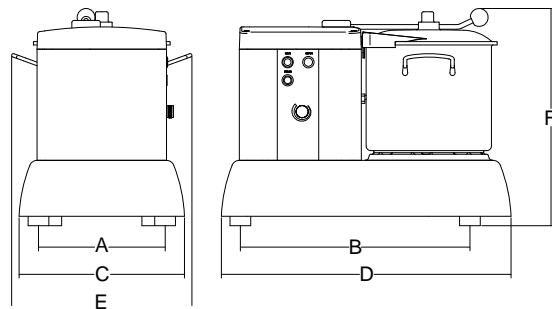

- Güçlü AISI 430 çelik gövde
- Daha iyi ısı yalıtımı için bağımsız motor ve kase
- Kalın tabanlı ve saplı paslanmaz kase
- Sürekli işleme uygun yüksek etkili soğutmalı motor
- Güçlü çelik bıçaklar
- Kapak üzerinde güvenli işletimi sağlayan mikro anahtarlar
- Şeffaf lexan kapak
- Sabitleyici hız kontrolü
- İşletim sırasında malzeme eklemeye uygun açılabilen kapak
- Kademesiz değişken hız sürücü
- Spatula ve bilek taşı dahildir
- Strong AISI 430 steel construction
- Detached motor and bowl for a better thermal insulation
- S/S bowl with handles and heavy bottom
- High efficiency ventilated motor for continuous operation
- Strong cutlery steel knives
- Safe operations ensured by a system of micro switches on the lid
- See-through lexan lid
- Variotronic: speed control with stabilizer
- Lid with opening to add ingredients during operation



Soğutmalı Motor  
Ventilated Motor

» Kod  
Code

Model  
Model

63010004  
63020004  
63030004  
63040004

Sebze Doğrayıcı / Vegetable Cutter  
Emülsiyon Bıçağı / Emulsifying Knife  
Dişli Bıçak / Serrated Knife  
Pesto Bıçağı (4 bıçaklı)/ Shaft w/knives for pesto sauce

\* Standart bıçak fiyata dahildir.  
\* Incl/Standard blade



Standart bıçak  
Standard knife

250

63020004



Emülsiyon Bıçağı  
Emulsifying Knife

63030004



Dişli Bıçak  
Serrated Knife

63040004



Pesto sosu için 4 bıçaklı shaft  
Shaft w/knives for pesto sauce

Güç / Power

350 W

Hazne Kapasitesi / Bowl Capacity

3,3 Lt

Hazne Dolma Seviyesi / Bowl Filling Level

1,5 Lt

Devir / Revolutions

r.p.m. 2.800

Net Ağırlık / Net Weight

10 Kg

Ölçüler / Dimensions

A B C D E  
160 mm 310 mm 305 mm 365 mm 255 mm

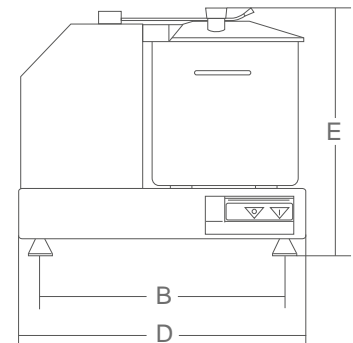
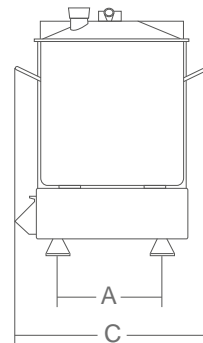

Made in Italy

- Güçlü AISI 430 çelik gövde
- Daha iyi ısı yalıtımı için bağımsız motor ve kase
- Kalın tabanlı ve saplı paslanmaz kase
- Sürekli işleme uygun yüksek etkili soğutmalı motor
- Güçlü çelik bıçaklar
- Kapak üzerinde güvenli işletimi sağlayan mikro anahtarlar
- Şeffaf lexan kapak
- Sabitleyici hız kontrolü
- İşletim sırasında malzeme eklemeye uygun açılabilen kapak
- Kademesiz değişken hız sürücü
- Spatula ve bilek taşı dahildir
- Strong AISI 430 steel construction
- Detached motor and bowl for a better thermal insulation
- S/S bowl with handles and heavy bottom
- High efficiency ventilated motor for continuous operation
- Strong cutlery steel knives
- Safe operations ensured by a system of micro switches on the lid
- See-through lexan lid
- Variotronic: speed control with stabilizer
- Lid with opening to add ingredients during operation

 Soğutmalı Motor  
Ventilated Motor

 >> Kod  
Code

 63010005  
63020005  
63030005  
63040005

 Model  
Model

 Sebze Doğrayıcı / Vegetable Cutter  
Emülsiyon Bıçağı / Emulsifying Knife  
Dişli Bıçak / Serrated Knife  
Pesto Bıçağı (4 bıçaklı) / Shaft w/knives for pesto sauce  
\* Standart bıçak fiyata dahildir.  
\* Incl/Standard blade

 Standart bıçak  
Standard knife

251

63020004

 Emülsiyon Bıçağı  
Emulsifying Knife

63030004

 Dişli Bıçak  
Serrated Knife

63040004

 Pesto sosu için 4 bıçaklı shaft  
Shaft w/knives for pesto sauce

Güç / Power

350 W

Hazne Kapasitesi / Bowl Capacity

5,3 Lt

Hazne Dolma Seviyesi / Bowl Filling Level

3,1 Lt

Devir / Revolutions

r.p.m. 1.500 + 2.800

Net Ağırlık / Net Weight

11 Kg

Ölçüler / Dimensions

A	B	C	D	E
160 mm	310 mm	305 mm	365 mm	320 mm

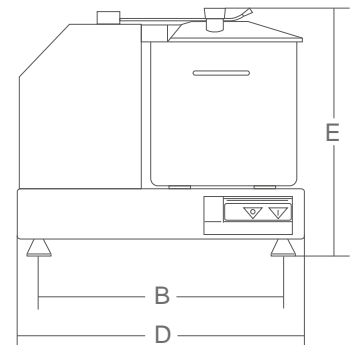
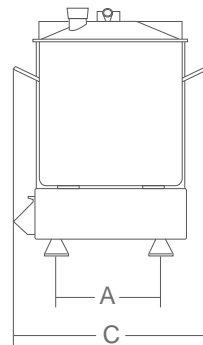

- Güçlü AISI 430 çelik gövde
- Daha iyi ısı yalıtımı için bağımsız motor ve kase
- Kalın tabanlı ve saplı paslanmaz kase
- Sürekli işleme uygun yüksek etkili soğutmalı motor
- Güçlü çelik bıçaklar
- Kapak üzerinde güvenli işlemi sağlayan mikro anahtarlar
- Şeffaf lexan kapak
- Sabitleyici hız kontrolü

- Base-plate and reservoir in heat-resistant ABS
- Lid in PC with hole to add the ingredients during processing
- Interlocked lid and reservoir, easy to disassemble though for cleaning
- Motor brake
- Control with NVR 24 Volt IP 67
- Included items:
- Hub with cutting knives in stainless steel
- Hub for ABS assembly
- Dismountable scraping blade



Sogutmalı Motor  
Ventilated Motor

» Kod  
Code

63010003  
63030006

Model  
Model

Sebze Doğrayıcı / Vegetable Cutter  
Temizleme Bıçağı / Board Scraper

\* Bıçaklar fiyata dahildir.

\* Knives included

252



Temizleme Bıçağı  
Board Scraper



Hamur karıştırıcı bıçaklı shaft  
Shaft w/knives to mix dough

Güç / Power

350 W

Hazne Kapasitesi / Bowl Capacity

3,3 Lt

Hazne Dolma Seviyesi / Bowl Filling Level

1,5 Lt

Devir / Revolutions

r.p.m. 2.800

Net Ağırlık / Net Weight

10 Kg

Ölçüler / Dimensions

A B C D E  
160 mm 310 mm 305 mm 365 mm 255 mm

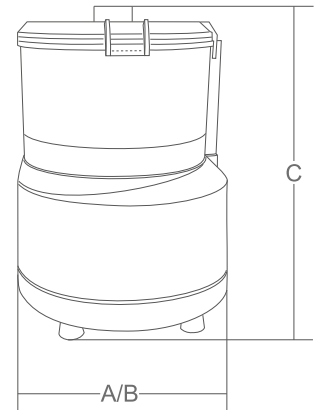

- Yüksek performans ve çalışma kapasiteli, tek parça dayanıklı cihaz
- Peyniri ve ekmeği aynı oranda ve ziyan etmeden rendeleme olanağı
- Cilalanmış alüminyum gövde, işlenmiş paslanmaz çelik silindir
- Strong machine, simple and compact, gives a high performance and power.
- It offers the possibility of grating cheese and bread with uniformity and without any waste.
- Structure realised in polished aluminium, treated steel roller anti-corrosive.



» Kod  
Code

63010021

Model  
Model

Peynir rendeleyici / Cheese Grater

253



Muhafazalı Rende / Paslanmaz çelik silindir  
Protection grater / Stainless steel drum



Rende üzerinde mikro anahtarı  
Microswitch on the grater

Güç / Power

588 W

Güç Kaynağı / Power Source

230 - 400 V/50-60 Hz F + N

Silindir Devri / Drum Revolutions

r.p.m. 1400

Giriş Ebatı / Mouth Revolutions

130 x 70

Net Ağırlık / Net Weight

16 Kg

Ölçüler / Dimensions

A B C D E F  
185 mm 270 mm 290 mm 390 mm 370 mm 560 mm

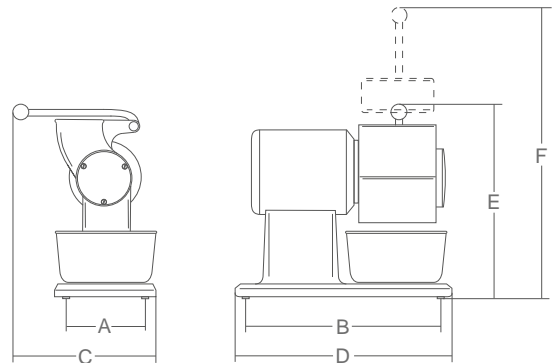

NEW



- Boyalı alüminyum gövde
- Döküm alüminyum parçalar
- Kolay temizlemeye uygun bıçak-motor aralığı
- Soğutmalı motor
- Hassas kalınlık ayarı desteği
- Kendi üzerine monteli bileyici düzenegi
- Küçük boyutlar ve yüksek kesme kapasitesi
- 25° bıçak eğim
- Anodized cast aluminium alloy
- Great distance between blade and motor for easy cleaning
- Ventilated motor
- Forged, hardened large thickness blades
- Strong thickness gauge support
- Cast-in sharpener assembly
- Compact dimensions and great cutting capacity
- CE professional with device for releasing the carriage
- 25° blade inclination

254

» Hamur Açma Makinesi  
Pasta Roller

Kod Code	Koli/Adet Pcs/Ctn
63010037	1

Güç / Power

370 W - Hp 0,5

Güç Kaynağı/ Power Source

1 ph / 3ph

Merdane Ölçüsü / Roller dimensions

ø 60 x 420 mm

Net Ağırlık / Net Weight

62 Kg

Ölçüler / Dimensions

A	B	E
296 mm	457 mm	300

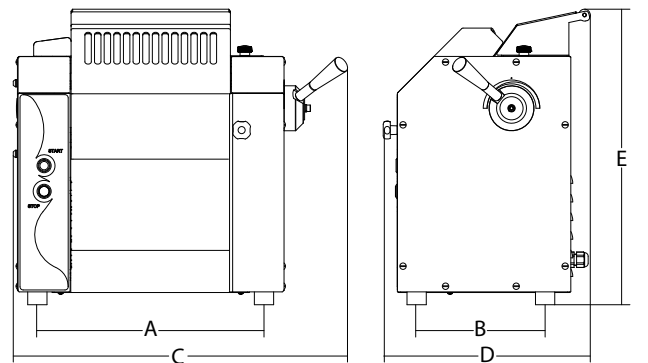

**NEW**

- Güvenilir, kullanımı kolay ve temizlemesi pratik
- AISI 304 paslanmaz çelik gövde
- Yağ banyolu redüktöre sahip güçlü, hava soğutmalı motor
- Yüksek performanslı ve kolayca çıkarılabilir yoğurma paleti
- Kilitlenebilir paslanmaz çelik kapak
- İşlem sırasında sıvı malzemelerin eklenmesi için çıkarılabilir huni
- Paslanmaz çelik kurt dişli, kafa ve halka
- Anodize alüminyumdan yapılmış hazne
- Her türlü kalıp için tam uyum
- IP 67 standartlarında paslanmaz çelik kontroller
- Yoğun kullanıma uygun hava soğutma sistemi

- Reliable, user-friendly and easy to clean
- AISI 304 stainless steel body
- Powerful, air-cooled motor with oil bath gear box reducer
- High-performance and easy to remove kneading paddle
- Interlocked stainless steel lid
- Convenient removable funnel to add liquid ingredients during processing
- Stainless steel worm, head and ring
- Bowl made of anodized aluminium
- Full availability of any kind of dies
- IP 67 stainless steel controls
- Forced air-cooling system for heavy-duty use

255

**» Makarna Erişte Makinesi**  
Pasta Machine

Kod Code	Koli/Adet Pcs/Ctn
63010036	1

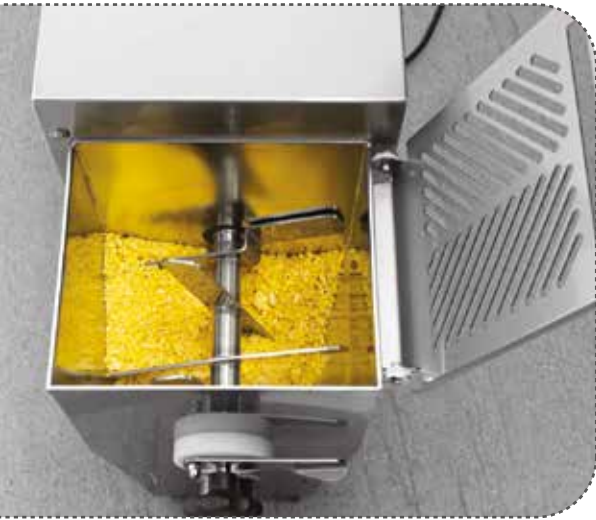

Güç / Power

W 750 - Hp 1

Güç Kaynağı / Power Source

1 ph

Kalıp Çapı / Dies:

ø 75 mm

Net Ağırlık / Net Weight

42 Kg

Ölçüler / Dimensions

A	B	E
296 mm	457 mm	300

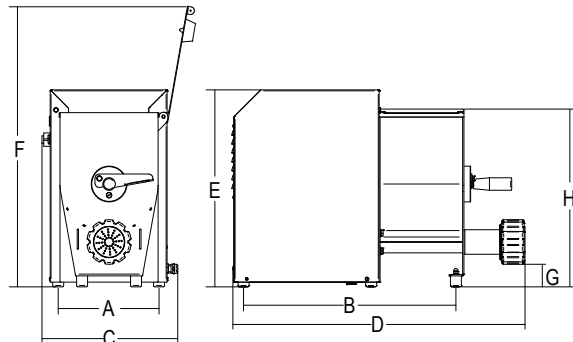

- Boyalı anodize alüminyum gövde
- Kolay temizlemeye uygun bıçak-motor aralığı
- Kayışlı soğutmalı motor
- Dövme, sertleştirilmiş, kalınlığı yüksek bıçaklar
- Daha fazla güvenlik sağlayan sabit halka bıçak koruması
- Hassas kalınlık ayarı desteği
- Kendi üzerine monteli bileyici düzenegi
- Küçük boyutlar ve yüksek kesme kapasitesi
- CE standartlarına uygun
- 25° bıçak eğim
- Painted anodized cast aluminium alloy
- Great distance between blade and motor for easy cleaning
- Belt drive ventilated motor
- Forged, hardened large thickness blades
- Equiped with fixed ring blade guard that guarantee more security
- Strong thickness gauge support
- Cast-in sharpener assembly
- Compact dimensions and great cutting capacity
- CE professional with device for releasing the carriage
- 25° blade inclination

NEW



250

Soğutmalı Motor  
Ventilated Motor

256

Kod Code	Model Model
65000250	Dilimleyici 250 / Slicer 250



Bıçak / Blade	Ø 250 mm
Motor / Motor	200 V
Kesme Kalınlığı / Cut Thickness	12 mm
Hareket Mesafesi / Run of Carriage	270 mm
Ağırlık / Weight	20 Kg
Hazne / Hopper	175 mm
Kesim Kapasitesi / Cut Capacity	170x205 mm

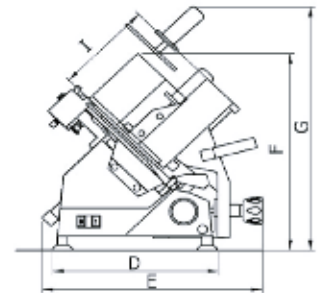
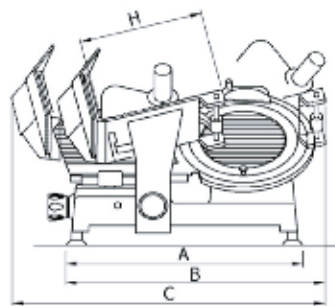

Ölçüler / Dimensions	A	B	C	D	E	F	G	H	I
	410 mm	480 mm	610 mm	320 mm	445 mm	410 mm	440 mm	230 mm	230 mm

- Boyalı anodize alüminyum gövde
- Kolay temizlemeye uygun bıçak-motor aralığı
- Kayışlı soğutmalı motor
- Dövme, sertleştirilmiş, kalınlığı yüksek bıçaklar
- Daha fazla güvenlik sağlayan sabit halka bıçak koruması
- Hassas kalınlık ayarı desteği
- Kendi üzerine monteli bileyici düzenegi
- Küçük boyutlar ve yüksek kesme kapasitesi
- CE standartlarına uygun
- 25 ° bıçak eğim
- Painted anodized cast aluminium alloy
- Great distance between blade and motor for easy cleaning
- Belt drive ventilated motor
- Forged, hardened large thickness blades
- Equiped with fixed ring blade guard that guarantee more security
- Strong thickness gauge support
- Cast-in sharpener assembly
- Compact dimensions and great cutting capacity
- CE professional with device for releasing the carriage
- 45 ° blade inclination

NEW



300

Soğutmalı Motor  
Ventilated Motor

257

» Kod  
Code

65000300

Model  
Model

Dilimleyici 300 / Slicer 300



Bıçak / Blade

Ø 300 mm

Motor / Motor

220 V

Kesme Kalınlığı / Cut Thickness

12 mm

Hareket Mesafesi / Run of Carriage

270 mm

Ağırlık / Weight

20 Kg

Hazne / Hopper

210 mm

Kesim Kapasitesi / Cut Capacity

210 x 230 mm

Ölçüler / Dimensions

A	B	C	D	E	F	G	H	I
485 mm	560 mm	630 mm	325 mm	475 mm	470 mm	490 mm	230 mm	230 mm

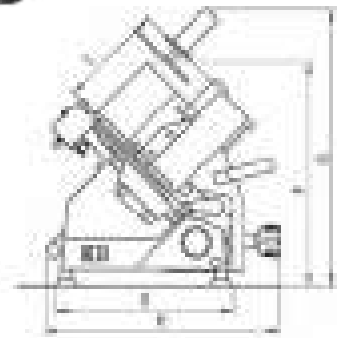
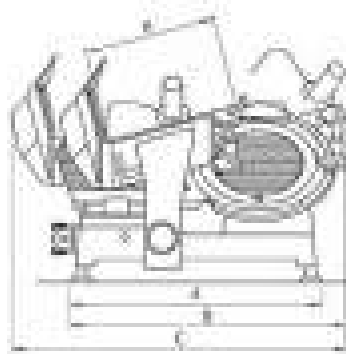

- Manuel çiçek desenli flywheel dilimleyici
- Tamamen alüminyumdan yapılmış, tamamen paslanmaz çelik parçalara sahip
- Çıkarılabilir ve bulaşık makinesinde yıkanabilir parçalar
- 100cr6 çelik bıçak
- Kendi üzerine monteli bileyici düzenegi
- Kompakt boyutlar ve yüksek kesme kapasitesi
- Dikey bıçak
- Manual flowered flywheel slicer
- Completely built in aluminum with completely s/s parts
- Removable and dishwasher safe parts
- 100cr6 steel blade
- Cast-in sharpener assembly
- Compact dimensions and great cutting capacity
- Vertical blade



## VOLANIÑA 250

258



» Volaniña Stand  
Volaniña Stand

Kod Code	Model Model
65100001	Kırmızı / Red
65200001	Krem / Cream
65300001	Siyah / Black

» Volaniña 250  
Volaniña 250

Kod Code	Model Model
65100250	Kırmızı / Red
65200250	Krem / Cream
65300250	Siyah / Black



Bıçak / Blade

Ø 250 mm

Kalınlık Ayarı / Thickness Adjuster

0-1,5 mm

Hareket Mesafesi / Run of Carriage

230 mm

Ağırlık / Weight

29 Kg

Hazne / Hopper

180 mm

Kesim Kapasitesi / Cut Capacity

210 x 180 mm

Ölçüler / Dimensions

A	B	C	D	E	F	G	H	I
415 mm	660 mm	660 mm	250 mm	430 mm	510 mm	510 mm	205 mm	235 mm

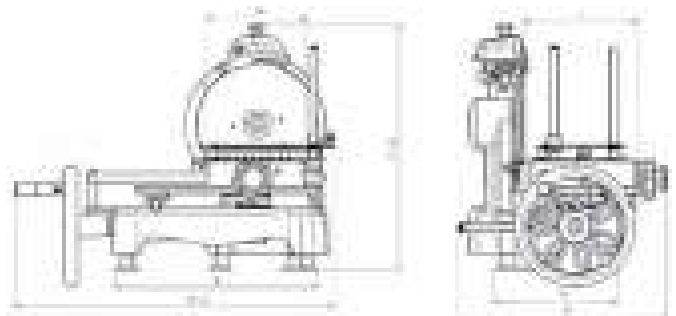

- Manuel çiçek desenli flywheel dilimleyici
- Tamamen alüminyumdan yapılmış, tamamen paslanmaz çelik parçalara sahip
- Çıkarılabilir ve bulaşık makinesinde yıkanabilir parçalar
- 100cr6 çelik bıçak
- Kendi üzerine monteli bileyici düzenegi
- Kompakt boyutlar ve yüksek kesme kapasitesi
- Dikey bıçak
- Manual flowered flywheel slicer
- Completely built in aluminum with completely s/s parts
- Removable and dishwasher safe parts
- 100cr6 steel blade
- Cast-in sharpener assembly
- Compact dimensions and great cutting capacity
- Vertical blade



## VOLANO 300

### » Volaniña Stand Volaniña Stand

Kod Code	Model Model
65100001	Kırmızı / Red
65200001	Krem / Cream
65300001	Siyah / Black



### » Volano 300 Volano 300

Kod Code	Model Model
65100300	Kırmızı / Red



Bıçak / Blade

Ø 300 mm

Kalınlık Ayarı / Thickness Adjuster

0-1,5 mm

Hareket Mesafesi / Run of Carriage

265 mm

Ağırlık / Weight

44,5 Kg

Hazne / Hopper

210 mm

Kesim Kapasitesi / Cut Capacity

250 x 210 mm

Ölçüler / Dimensions

A	B	C	D	E	F	G	H	I
470 mm	530 mm	790 mm	280 mm	570 mm	520 mm	680 mm	240 mm	295 mm

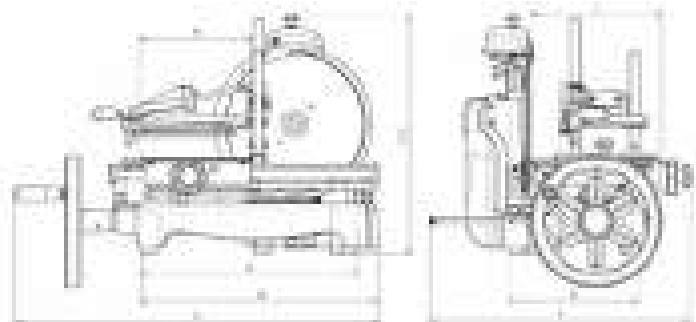

- Boyalı alüminyum gövde
- Döküm alüminyum parçalar
- Kolay temizlemeye uygun bıçak-motor aralığı
- Soğutmalı motor
- Hassas kalınlık ayarı desteği
- Kendi üzerine monteli bileyici düzenegi
- Küçük boyutlar ve yüksek kesme kapasitesi
- 25° bıçak eğim
- Anodized cast aluminium alloy
- Great distance between blade and motor for easy cleaning
- Ventilated motor
- Forged, hardened large thickness blades
- Strong thickness gauge support
- Cast-in sharpener assembly
- Compact dimensions and great cutting capacity
- CE professional with device for releasing the carriage
- 25° blade inclination



250

Soğutmalı Motor  
Ventilated Motor

260

» Kod  
Code

63010250

Model  
Model

Dilimleyici 250 / Slicer 250



Bıçak / Blade

Ø 250 mm

Motor / Motor

147 W / 0,20 Hp

Kesme Kalınlığı / Cut Thickness

13 mm

Hareket Mesafesi / Run of Carriage

245 mm

Hazne / Hopper

230 x 230 mm

Kesim Kapasitesi / Cut Capacity

215 x 180

Ölçüler / Dimensions

A	B	C	D	E	F	G	L
395 mm	245 mm	500 mm	560 mm	370 mm	570 mm	475 mm	490 mm

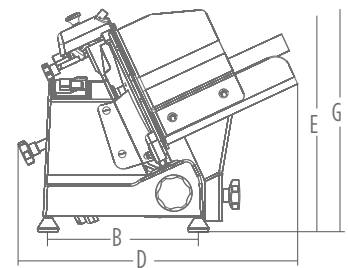
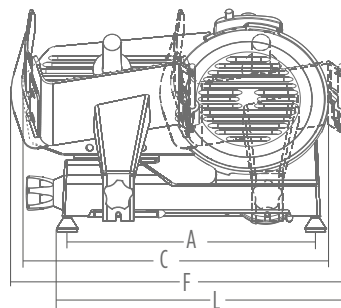

- Elokсалlı alüminyum alaşım gövde
- Kolay temizlemeye uygun bıçak-motor aralığı
- Soğutmalı motor
- Güçlendirilmiş ve sertleştirilmiş kalınlık ayar bıçakları
- Kendinden yağlamalı mil yatağı
- Hassas kalınlık ayarlama kolu
- Yüksek kesim kapasitesi
- 25° bıçak eğimi
- Anodized cast aluminium alloy
- Great distance between blade and motor for easy cleaning
- Ventilated motor
- Forged, hardened large thickness blades
- Strong thickness gauge support
- Cast-in sharpener assembly
- Compact dimensions and great cutting capacity
- CE professional with device for releasing the carriage
- 25° blade inclination

**250**Soğutmalı Motor  
Ventilated Motor» Kod  
Code

63010026

Model  
Model

Dilimleyici 250 / Slicer 250

261



Bıçak / Blade

Ø 250 mm

Motor / Motor

147 W / 0,20 Hp

Kesme Kalınlığı / Cut Thickness

13 mm

Hareket Mesafesi / Run of Carriage

245 mm

Hazne / Hopper

230 x 230 mm

Kesim Kapasitesi / Cut Capacity

215 x 180

Ölçüler / Dimensions

A	B	C	D	E	F	G
395 mm	245 mm	500 mm	560 mm	370 mm	570 mm	475 mm

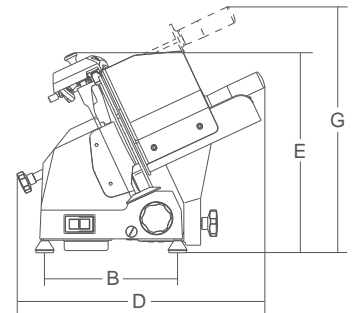
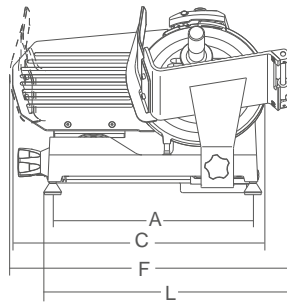

- Eloksallı döküm alüminyum gövde
- Kolay temizlemeye uygun bıçak - motor aralığı
- Soğutmalı motor
- Güçlendirilmiş, kalın dövme bıçaklar
- Kendinden yağlamalı mil yatağı ve üst üste bindirilmiş pim üzerinde çalışan hareketli parça
- Hassas kalınlık ayarı desteği
- Küçük boyutlar ve yüksek kesme kapasitesi
- 25° bıçak eğimi

- Anodized cast aluminium alloy
- Great distance between blade and motor for easy cleaning
- Ventilated motor
- Forged, hardened large thickness blades
- Strong thickness gauge support
- Cast-in sharpener assembly
- Compact dimensions and great cutting capacity
- CE professional with device for releasing the carriage
- 25° blade inclination



300

Soğutmalı Motor  
Ventilated Motor

262

» Kod  
Code

63010300

Model  
Model

Dilimleyici 300 / Slicer 300

Hareketli parçayı ayıran mekanizma  
Device for releasing the carriageKolay temizlemeye uygun bıçak - motor aralığı  
More space between blade and body machineKapalı ve sızdırmaz kayış kasnağı  
Enclosed and sealed belt pulley standard

Bıçak / Blade

Ø 300 mm

Motor / Motor

210 W

Kesme Kalınlığı / Cut Thickness

13 mm

Hareket Mesafesi / Run of Carriage

285 mm

Hazne / Hopper

250x275 mm

Kesim Kapasitesi / Cut Capacity

20,5 Kg

Ölçüler / Dimensions

A	B	C	D	E	F	G	L
435 mm	295 mm	600 mm	610 mm	420 mm	640 mm	510 mm	535 mm

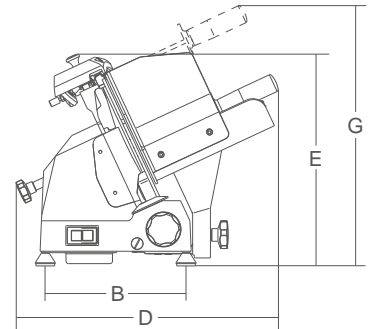
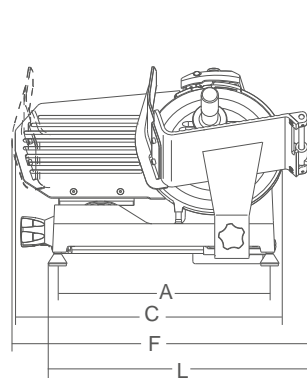

Made in Italy

- Köşesiz, yuvarlak dizayn
- Hareketli parça üzerinde sertleştirilmiş kauçuk durdurucular
- Kapalı ve sızdırmaz kayış kasnağı
- Motor ve bıçak arasında 49,5 mm mesafe
- Taban kapağı
- 110- 220- 380 V değiştirilebilir tek ve üç aşamalı elektronik devir
- Taban korumalı gömme bileyici
- Bıçak çıkartma aparatı
- 35° bıçak eğimi
- IP67 koruma seviyeli plastik basma düğmeleri
- Rounded design, no sharp edges and visible screws
- Vulcanized rubber stops on carriage
- Removable support cover for thickness gauge plate
- Enclosed and sealed belt pulley
- 49,5 mm distance between blade and motor
- Bottom cover
- Changeover electronic circuit 110-220-380 V single and three phase
- Built in sharpening tool with bottom protection
- Standard blade removal tool
- 35° blade inclination
- Plastic pushbuttons with IP67 protection rating

 Soğutmalı Motor  
Ventilated Motor

350

263

» Kod  
Code  
63010350

Model  
Model  
Dilimleyici 350 / Slicer 350

 Bıçak ve gövde arasında daha fazla mesafe  
More space between blade and body machine

 Geniş Hazne  
Large hopper

Bıçak / Blade	Ø 350 mm
Motor / Motor	370 W
Kesme Kalınlığı / Cut Thickness	23 mm
Hareket Mesafesi / Run of Carriage	310 mm
Hazne / Hopper	305x270 mm
Kesim Kapasitesi / Cut Capacity	46 Kg
Ölçüler / Dimensions	

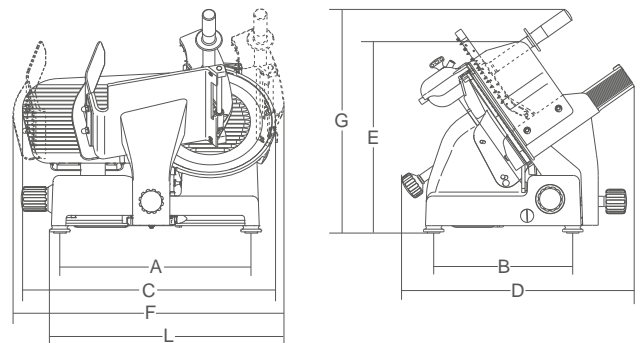

A	B	C	D	E	F	G	L
465 mm	340 mm	660 mm	575 mm	455 mm	710 mm	530 mm	590 mm

- Köşesiz, yuvarlak dizayn
- Motor ve bıçak arasında 48 mm mesafe
- Krom kaplamalı, kayar mil
- Hareketli parça üzerinde sertleştirilmiş kauçuk durdurucular
- Kalınlık ayar bıçağı üzerinde çıkarılabilir koruma kapağı
- Elektrik aksamına erişimi engelleyen alt kapak
- Taban korumalı dahili bileyici
- Bıçak çıkartma aparatı
- IP67 koruma seviyeli plastik düğmeler
- Rounded design and no sharp edges or visible screws
- Chrome plated ground and lapped slide rod
- Vulcanised rubber stops on carriage
- Removable support cover for thickness gauge plate
- Bottom cover for accessing electrical components
- Built-in sharpening tool with bottom protection
- Easy to remove grease guard mounted along the thickness gauge plate
- Standard blade removal tool
- Plastic pushbuttons with IP67 protection rating



## Dik Tip Vertical

Soğutmalı Motor  
Ventilated Motor

264

» Kod  
Code  
63010027

Model  
Model  
Dik Tip Dilimleyici / Vertical Slicer

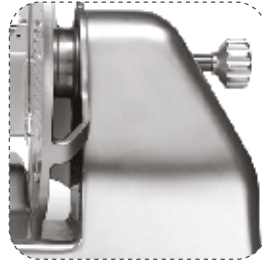

Bıçak / Blade  
Motor / Motor  
Kesme Kalınlığı / Cut Thickness  
Hareket Mesafesi / Run of Carriage  
Hazne / Hopper  
Kesim Kapasitesi / Cut Capacity  
Ölçüler / Dimensions

Ø 350 mm  
370 W / 0,50 Hp  
29 mm  
310 mm  
300 x 270 mm  
215 x 180

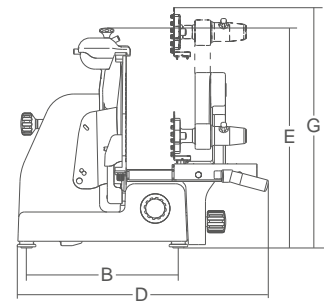
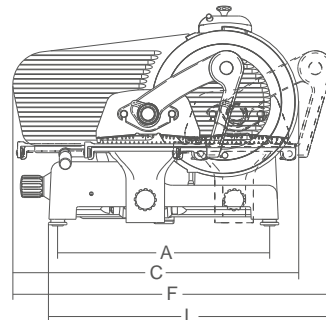

A 468 mm B 338 mm C 660 mm D 600 mm E 530 mm F 750 mm G 715 mm L 630 mm

**NEW**

- Metal Döküm planet mikser
  - Kaldırılabilir üst parça sayesinde çıkabilir hazne ve ekipmanlar, kolay temizlik
  - Çıkarılabilir 7 lt paslanmaz çelik kase
  - 3 adet metal aparat
  - Hız kontrollü D.C. motor
  - Üst gövde de güvenlik kilidi
  - NVR cihazı
  - Orta yoğunluklu karışım için uygundur
  - Yüksek yoğunluklu karışım için uygun değildir
- Metal cast planetary mixer
  - Lifiable head for bowl and tools removal and easy cleaning
  - Removable, S/S, 7L bowl
  - 3 metal tools
  - D.C. motor with speed control
  - Safety microswitch on the head
  - NVR device
  - Suitable for medium density mix (for ex. Bread dough, about 1 kg of flour)
  - NOT suitable for tough mix

» Çift Kollu Mikser  
Double Arm Mixer

Kod Code	Koli/Adet Pcs/Ctn
63040010	1

Güç / Power

Güç Kaynağı / Power Source

Tank Devri / Revolutions tank:

Hazne Kapasitesi / Tank dimensions

Net Ağırlık / Net Weight

Ölçüler / Dimensions

W 750 / Hp 1

1 ph

rpm 6 ÷ 14

ø 320x165 mm

61 Kg

A	D	F
318mm	582 mm	933 mm

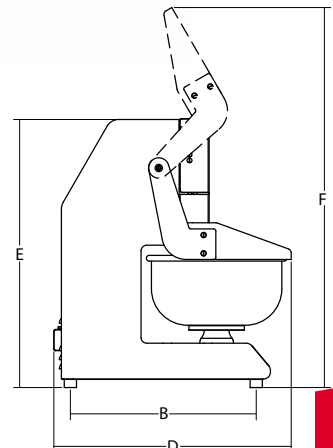
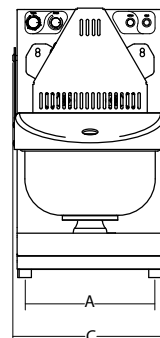

- Metal Döküm planet mikser
- Kaldırılabilir üst parça sayesinde çıkabilir hazne ve ekipmanlar, kolay temizlik
- Çıkarılabilir 7 lt paslanmaz çelik kase
- 3 adet metal aparat
- Hız kontrollü D.C. motor
- Üst gövde de güvenlik kilidi
- NVR cihazı
- Orta yoğunluklu karışım için uygundur
- Yüksek yoğunluklu karışım için uygun değildir

- Metal cast planetary mixer
- Lifiable head for bowl and tools removal and easy cleaning
- Removable, S/S, 7L bowl
- 3 metal tools
- D.C. motor with speed control
- Safety microswitch on the head
- NVR device
- Suitable for medium density mix (for ex. Bread dough, about 1 kg of flour)
- NOT suitable for tough mix



7 Lt

266

» Kod  
Code

63010007

Model  
Model

Planet Mikser 7 Lt / Planet Mixer 7 Lt

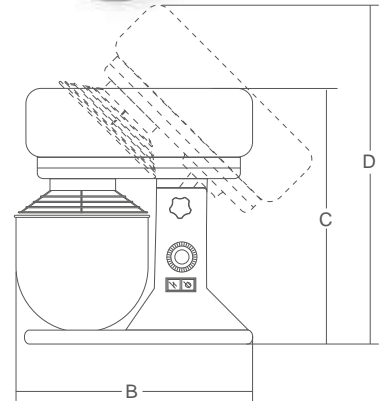
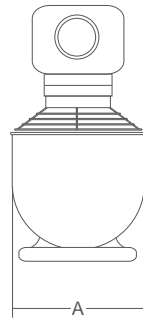

Güç / Power

280 W

Güç Kaynağı / Power Source

230 V/50 Hz

Çırpma Devri / Whisk Revolutions

g./75 + 660

Hazne Kapasitesi / Bowl Capacity

7 Lt

Net Ağırlık / Net Weight

18 Kg

Ölçüler / Dimensions

A	B	C	D
240 mm	410 mm	425 mm	540 mm

- Yüksek kalınlıkta toz boya kaplı çelik gövde
- Metal ızgara korumalı hazne
- Kolay çıkarılabilir 304 paslanmaz çelik hazne
- Hazne ve kapak için güvenlik kilidi
- Çıkarılabilir 3 metal parça: alüminyum spatula, kanca, çelik ve alüminyum çırpıcı
- 3 hız kademesi
- Çelik şanzıman kutusu
- Soğutmalı motor

- Machine body made from large thickness powder coated steel
- Bowl protection made from metal wire
- Easy to remove bowl made from stainless steel 304
- Safety microswitches for the lid and the bowl
- 3 easy to remove metal tools: aluminium spatula and hook, steel and aluminium whisk
- 3 speed gear
- Steel gear box
- Ventilated motor

**Minneapolis**

267

10 Lt

>> Kod  
Code

63010010

Model  
Model

Planet Mikser 10 Lt / Planet Mixer 10 Lt

Güç / Power

450 W

Güç Kaynağı / Power Source

230 V/50 Hz

Çırpma Devri / Whisk Revolutions

108/195/355 r.p.m.

Hazne Kapasitesi / Bowl Capacity

10 Lt

Net Ağırlık / Net Weight

74 Kg

Ölçüler / Dimensions

A	B	C	D	E
360 mm	345 mm	440 mm	500 mm	630 mm

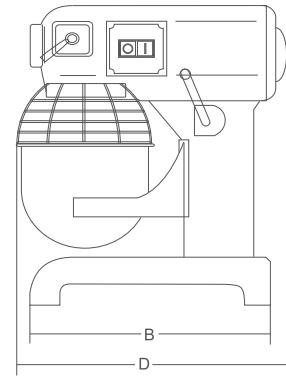
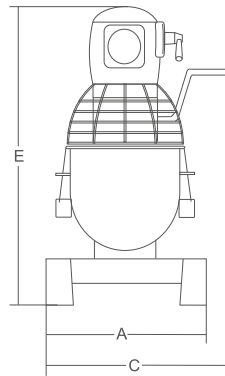

- Tezgah üstü model; Hijyenik ve paslanmaz polisajlı eloksallı alüminyum gövde
- Paslanmaz çelik kesim tablası, et itici ve et dilimleyici
- Kemik veya et kesmeye uygun 16 mm, geniş, güçlendirilmiş bıçaklar (donmuş ve taze)
- Kapı üzeri ve motor fren mikroswitchi ( yeni CE güvenlik kurallarına göre)
- 24V emniyetli kontrol
- Makaraların yarı bükülmüş şekli sayesinde mükemmel bıçak-makara tutuşu
- Yağ keçesi ile korunan 4 kutuplu eşzamansız ve soğutmalı motor
- Güvenli ve kolay kullanım
- Table-top model; cast anodizedaluminium alloy construction, polished, hygienic and rustproof
- Cutting table, meat pusher and meat pusher in stainless steel AISI 304
- 24V controls with safety codified microswitches on the door and motor brake (according to new CE safety rules)
- Powerful asynchronous and ventilated 4-pole motors protected by sealing oil ring
- 16 mm wide tempered ring-blades useful for cutting bones or meat (frozen or fresh)
- Simple and sturdy machine: safe and easy to use



268



» Kod  
Code

63010048

Model  
Model

Et-Kemik Testeresi / Bone Saw

Bıçak Uzunluğu / Blade Length

1840 mm

Motor / Motor

1100 W / Hp 1,5

Makara / Pulley

250 mm

Net Ağırlık / Net Weight

40 Kg

Ölçüler / Dimensions

A	B	C	D	E	F	G
530 mm	600 mm	640 mm	950 mm	915 mm	250 mm	240 mm

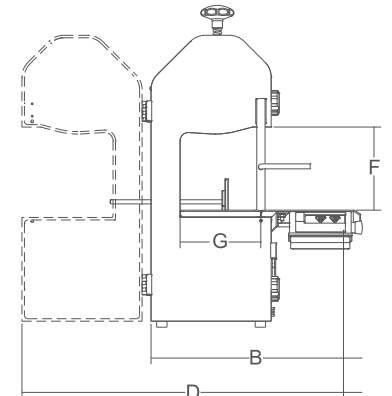
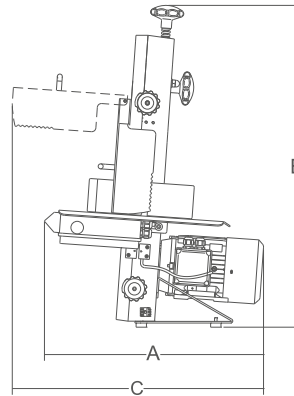

- Tezgah üstü model; Hijyenik ve paslanmaz polisajlı eloksallı alüminyum gövde
- Paslanmaz çelik kesim tablası, et itici ve et dilimleyici
- Kemik veya et kesmeye uygun 16 mm, geniş, güçlendirilmiş bıçaklar (donmuş ve taze)
- Kapı üzeri ve motor fren mikroswitchi ( yeni CE güvenlik kurallarına göre)
- 24V emniyetli kontrol
- Makaraların yarı bükülmüş şekli sayesinde mükemmel bıçak-makara tutuşu
- Yağ keçesi ile korunan 4 kutuplu eşzamansız ve soğutmalı motor
- Güvenli ve kolay kullanım
- Table-top model; cast anodizedaluminium alloy construction, polished, hygienic and rustproof
- Cutting table, meat pusher and meat pusher in stainless steel AISI 304
- 24V controls with safety codified microswitches on the door and motor brake (according to new CE safety rules)
- Powerful asynchronous and ventilated 4-pole motors protected by sealing oil ring
- 16 mm wide tempered ring-blades useful for cutting bones or meat (frozen or fresh)
- Simple and sturdy machine: safe and easy to use



269

» Kod  
Code

63010028

Model  
Model

Et-Kemik Testeresi / Bone Saw

Bıçak Uzunluğu / Blade Length

1550 mm

Motor / Motor

1 ph-Hp 1/r.p.m. 1400  
3 ph-Hp 1,5/r.p.m. 1400

Makara / Pulley

210 mm

Net Ağırlık / Net Weight

32 Kg

Ölçüler / Dimensions

A	B	C	D	E	F	G
530 mm	510 mm	606 mm	822 mm	778 mm	215 mm	195 mm

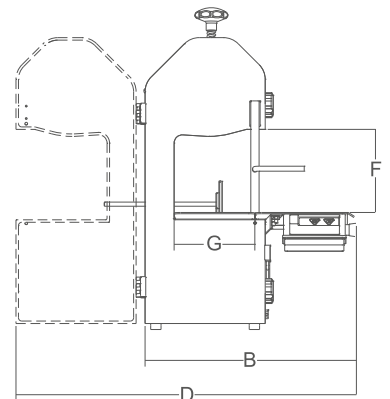
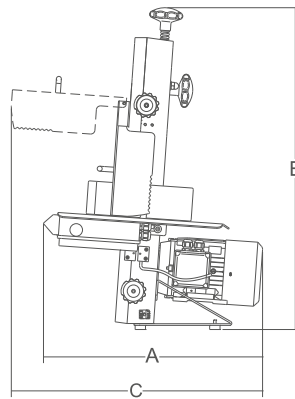

- Düşük hacimli ürünler için kompakt ve hızlı paketlenme
- Vakum ve yapıştırma zaman ayarı
- Gösterge Paneli: Vakum yüzdesi ve kalan zaman göstergesi
- Yağ değiştirme uyarısı
- Zaman ayarlı dış vakum
- DVP vakum pompası
- Softcooker cihazı ile ideal kombinasyon
- A compact and fast machine for small sized product
- Easily settable vacuum and sealing time
- Bush suction pump
- Display of vacuum percentage and time to countdown
- Rev counter and pump meter
- Pump preheating and oil cleaning cycle
- Change oil message
- Timed external vacuum



Güç / Power	0,1 kw
Güç Kaynağı / Power Source	230 V/50 Hz
Vakum Pompası / Vacuum Pump	mc/h 4
Net Ağırlık / Net Weight	30 Kg
Ölçüler / Dimensions	320x560x257 mm

270



» Kod  
Code  
63010030

Model  
Model  
Vakumlu Paket Makinesi  
Vacuum Packaging Machines

- Vakum ve yapıştırma zaman ayarı
- Gösterge Paneli: Vakum yüzdesi ve kalan zaman göstergesi
- Son kullanılan ayarın hafızaya kaydedilebilme özelliği
- Her vakum döngüsünden sonra otomatik açılan kapak
- Yağ değiştirme uyarısı
- Zaman ayarlı dış vakum
- Ön ısıtma pompası ve yağ temizleme döngüsü

- Easy vacuum and sealing time setting
- Display of vacuum percentage and time to countdown
- Last setting saved in memory
- Rev counter and pump meter
- Pump preheating and oil cleaning cycle
- Oil change message
- Timed external vacuum
- Automatic cover lift operated by pneumatic pistons

Güç / Power	0,45 Kw
Güç Kaynağı / Power Source	230 V/50 Hz
Vakum Pompası / Vacuum Pump	mc/h 12
Net Ağırlık / Net Weight	54 Kg
Ölçüler / Dimensions	493x585x370 mm



» Kod  
Code  
63010035

Model  
Model  
Vakumlu Paket Makinesi  
Vacuum Packaging Machines

- Hacmi büyük ölçüde artırılmış çan tasarımı
- Kolayca çıkarılabilir sızdırmazlık çubuğu
- Kontroller: Vakum ve sızdırma süresinin hızlı ve sezgisel bir şekilde ayarlanabildiği manuel kontroller.
- Kolay temizlik: Destek ürün yüzeyinin tamamen düz olması sayesinde temizliği son derece kolaydır.
- Pneumatik pistonlar sayesinde kapağın otomatik olarak kaldırılması.
- Sıvı torbaları için özel yüzey
- Analog vakum göstergesi
- Bell in great development of volume
- Easily removable sealing bar
- Controls Manual controls with fast and intuitive adjustment of vacuum and sealing time
- Extremely easy to clean thanks to the perfect flatness of the support product plan.
- Automatic lifting the lid by means of pneumatic pistons.
- Surface for liquid bags
- Analogic vacuum gauge

**NEW**

» Vakum Paketleme Makinesi Manuel  
Manuel Vacuum Packing Machine

Kod Code	Koli/Adet Pcs/Ctn
63040006	1

271



Güç / Power	kw 0,75
Güç Kaynağı / Power Source	1ph
Vakum Pompası / Vacuum Pump	20 mc/h
Net Ağırlık / Net Weight	54 Kg
Ölçüler / Dimensions	A B C
	493 mm 585 mm 442 mm

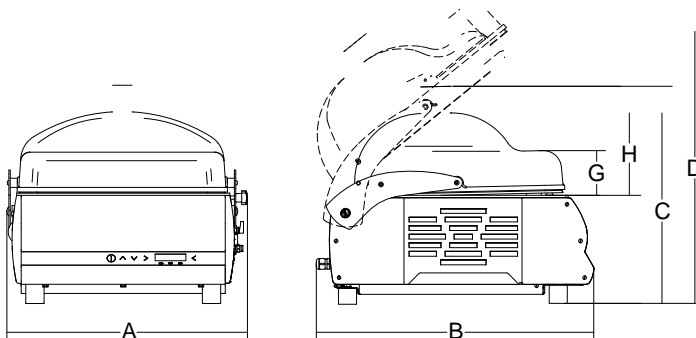

- Basit ve sezgisel, vakumlu pişirmeye başlangıç için ideal
- Kolay okunabilir LED ekran
- Hızlı zaman ve sıcaklık ayarı
- Motorlu fan ile dolaşım
- 20 litreye kadar su için ideal

- Simple and intuitive, ideal for initial approach to vacuum cooking
- Easy-to-read LED display
- Fast setting of time and temperature
- Circulator via motorised fan
- Ideal up to 20 l of water



272

» Softcooker Light  
Softcooker Light

Kod Code	Koli/Adet Pcs/Ctn
69040002	1



Güç / Power	1200 Watt
Güç Kaynağı / Power Source	1 ph
Isı / Temperature	°C 90
Kapasite/ Capacity	20 lt
Net Ağırlık / Net Weight	1,2 Kg
Ölçüler / Dimensions	C      D      G 95 mm   154 mm   419 mm

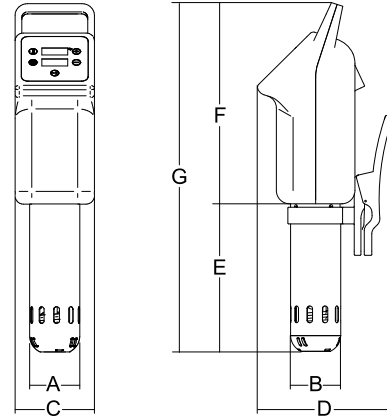

Made in Italy

- Su statik ısıtma sistemiyle düşük sıcaklıkta pişirme cihazı.
- Yapısı, tankı ve kapağı paslanmaz çelikten üretilmiştir.
- Kolay taşınabilirlik için pratik taşıma kolları bulunur.
- Tankın altında güçlü zırhlı temaslı ısıtma elemanları.
- 0,2°C sıcaklık hassasiyetiyle Wi-Food dokunmatik kontrol sistemi.
- Android ve iOS sistemleri için ücretsiz olarak indirilebilen bir uygulama üzerinden kullanılabilir.
- Ekran kutusu için manyetik bir sistemle en rahat ve erişilebilir konuma yerleştirilebilen pratik bir pozisyonlama braketi.
- Cihazda 10 programa kadar kayıt imkanı ve uygulama üzerinden çok daha fazlası.
- Sıcaklık °C ve °F birimlerinde ayarlanabilir.
- Suyun tahliyesi için pratik bir musluk.

- Low temperature cooking device with water static heating.
- Structure, tank and lid made of stainless steel.
- Practical handles to carry it easily
- Powerful armoured contact heating elements in the bottom of the tank.
- Wi-Food touch control with 0.2°C T delta.
- Can be used through a free app, downloadable for both the Android and iOS systems.
- The practical positioning bracket for the display box allows for placing the controls – by means of a magnetic system – in the most comfortable and accessible location.
- Up to 10 programmes storable on the machine and many more through the APP.
- Temperature settable in °C and in °F.
- Practical tap for discharging the water.

NEW



273

» Softcooker Wi-Food Nfc  
Softcooker Wi-Food Nfc

Kod Code	Koli/Adet Pcs/Ctn
63040007	1

Güç / Power	2000 Watt
Güç Kaynağı / Power Source	1 ph
Isı / Temperature	°C 24 ÷ 99,9 F° 75,2 ÷ 199,9
Net Ağırlık / Net Weight	4,5 Kg
Ölçüler / Dimensions	A B F 165 mm 109 mm 377 mm

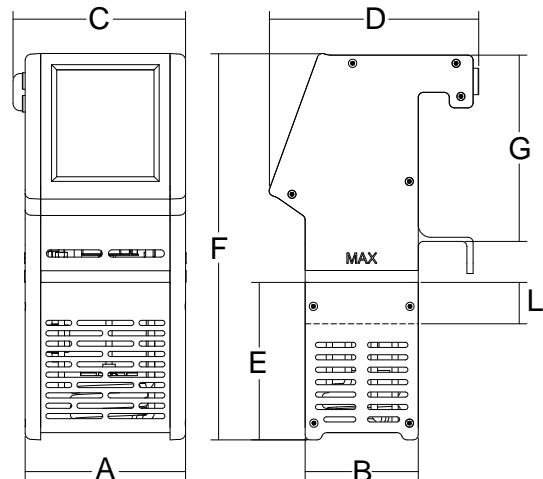

- Düşük ısıda vakumlu gıda pişirme cihazı
- Hafızaya alınabilir 5 ayrı program
- 50 - 80 lt kullanım kapasitesi
- Isı göstergeli
- Sıvısız yanlış kullanım durumunda cihazı otomatik kapatan koruma sistemi
- Aşırı yükleme ve aşırı ısınmayı engelleyen ısı sensörü
- Kullanılan gıda konteynırına sabitleme kelepçesi (maks. Derinlik 16,5 cm)
- Kolay taşıma sağlayan paslanmaz çelik sap

- High precision warmer with temperature control
- Working temperature display
- 5 storable programs
- IP X3 protection rated stainless steel structure
- Can be applied to the pot by means of a clamp. (max depth 16,5 mc)
- Best performances up to 50/80 lt
- Protection device switches off the warmer in case of accidental use outside the liquid
- Circulating pump to help the best product mixing
- Temperature sensor to prevent overload and overheating
- A convenient stainless steel handle makes it easy to carry



274

» Kod  
Code

63010051

Model  
Model

Soft Cooker



Güç / Power

2000 Watt

Güç Kaynağı / Power Source

230 V/50 Hz

Isı / Temperature

°C 40 / 115

Net Ağırlık / Net Weight

4,5 Kg

Ölçüler / Dimensions

A	B	C	D	E	E	G
110 mm	105 mm	130 mm	260 mm	170 mm	170 mm	210 mm

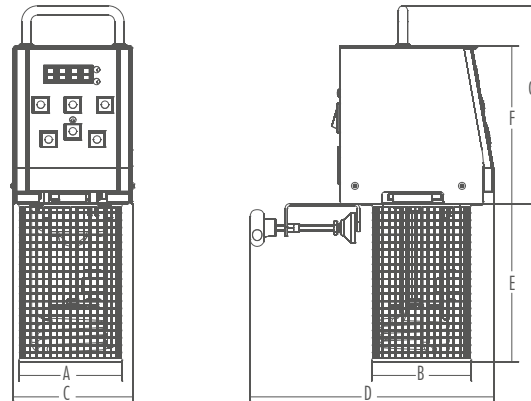

- Paslanmaz Çelik gövde ve GN 1/1 küvet
  - Hafızaya alınabilir 5 ayrı program
  - Isı göstergeli elektronik ısı kontrolü
  - Alt tankla bağlantılı darbe dayanıklı ısıtma parçaları
  - C° and F°de ısı ayar seçenekleri
  - Kolay taşıma için pratik saplar
- Stainless steel structure and 1/1 GN made of stainless steel
  - Practical handles to carry it easily
  - Powerful shock-proof coated heating elements in contact with tank bottom
  - Electronic control system of the temperature with working temperature display
  - Same control system of Softcooker with delta T of 0,2°C
  - 5 storable programs
  - Temperature setting in C° and F°
  - Equipped with lid



» Kod  
Code  
63010049

Model  
Model  
Softcooker GN 1/1

275



Güç / Power

1150 Watt

Güç Kaynağı / Power Source

230 V/50 Hz

Isı / Temperature

°C 40 / 115

Net Ağırlık / Net Weight

5 Kg

Ölçüler / Dimensions

X Y H  
110 mm 105 mm 130 mm

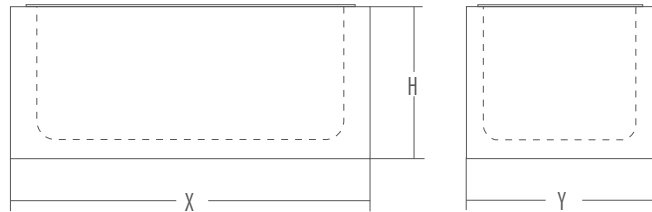

## Naboo 5.0

NEW

- Akıllı Teşhis Sistemi
  - Akıllı Aydınlatma Sistemi
  - Akıllı Kimyasalların Kontrolü
  - Güçlü buhar jeneratörü
  - Enerji monitörü
  - VCS yıkama sistemi
  - 320°C'ye kadar ön ısıtma
  - Kolay bakım, kolay kurulum
  - Yapılandırılabilir ekran
- Smart Diagnostic System
  - Smart Lighting System
  - Smart Control of Chemicals
  - Powerful Steam Generator
  - Energy Monitor
  - VCS Washing System
  - Preheating up to 320°C
  - Easy Maintenance and Installation
  - Configurable Display



276

Elektrikli Buharlı Fırın  
Electric Combination Oven

>> Kod Code	Model Model	Kapasite Capacity	Ölçü (mm) Dim (mm)
63020055	Elektrikli Buharlı / Electric Combination	6 Gn 1/1 Tepsili	797x775x852
63030055	Gazlı Buharlı / Gas Combination	6 Gn 1/1 Tray	797x775x852

Güç / Power	11,6 kW
Elektrik Girişi / Power Supply Voltage	3N-AC 400 V - 50/60
Kapasite / Capacity	6 x GN 1/1 - 6 x EN1 (600x400)
Ölçüler / Dimensions	82,5 x 79,7 x 77,5 cm

Elektrikli Buharlı / Electric Combination

Güç / Power	0,7 kW
Elektrik Girişi / Power Supply Voltage	1N-AC 230 V - 50/60
Kapasite / Capacity	6 x GN 1/1 - 6 x EN1 (600x400)
Ölçüler / Dimensions	82,5 x 79,7 x 77,5 cm

Gazlı Buharlı / Gas Combination

- 100°C ila 300°C arasında sıcaklıklarda konveksiyon, mikrodalga ve çarpma modlarını aynı anda kullanan bir çalışma modu.
- Yüksek Hızlı Fırın modunda yüksek hızlı pişirme için otomatik, denenmiş ve test edilmiş tarifleri kullanarak Lainox'un teknik bilgisine güvenin.
- Oracle, Combi Wave modunda 30°C ila 300°C sıcaklıklarda konveksiyonlu fırın olarak, 2000W'a kadar güce sahip mikrodalga fırın olarak veya iki pişirme yönteminin kombinasyonu ile kullanılabilir ve her zaman beklentileri aşan sonuçlar elde edilebilir.
- Combi Wave modunda pişirme için otomatik, denenmiş ve test edilmiş tarifleri kullanarak Lainox'un bilgi birikimine güvenin.
- Oracle, standart Wi-Fi ve ethernet özellikleri aracılığıyla Lainox'un Nabook plus portalına ücretsiz bağlanarak size 4.0 mutfak sunuyor.

- A working mode that simultaneously uses convection, microwave, and impingement modes at temperatures ranging from 100°C to 300°C.
- Trust Lainox's technical expertise by using automatic, tried, and tested recipes for high-speed cooking in High-Speed Oven mode.
- Oracle can be used as a convection oven at temperatures ranging from 30°C to 300°C in Combi Wave mode, as a microwave oven with power up to 2000W, or as a combination of both cooking methods, always delivering results that exceed expectations.
- Trust Lainox's expertise by using automatic, tried, and tested recipes for cooking in Combi Wave mode.
- Oracle offers you a 4.0 kitchen by connecting to Lainox's Nabook Plus portal for free via standard Wi-Fi and Ethernet features.

## Naboo 5.0

NEW



277

Elektrikli Buharlı Fırın  
Electric Combination Oven

» Kod Code	Model Model	Kapasite Capacity	Ölçü (mm) Dim (mm)
63020056	Elektrikli Buharlı / Electric Combination	10 Gn 1/1 Tepsili	852x797x1050
63030056	Gazlı Buharlı / Gas Combination	10 Gn 1/1 Tray	852x797x1050

Güç / Power	18,7 kW
Elektrik Girişi / Power Supply Voltage	3N-AC 400 V - 50/60
Kapasite / Capacity	10 x GN 1/1 - 10 x EN1 (600x400)
Ölçüler / Dimensions	82,5 x 79,7 x 77,5 cm

Elektrikli Buharlı / Electric Combination

Güç / Power	0,8 kW
Elektrik Girişi / Power Supply Voltage	1N-AC 230 V - 50/60
Kapasite / Capacity	10 x GN 1/1 - 10 x EN1 (600x400)
Ölçüler / Dimensions	82,5 x 79,7 x 77,5 cm

Gazlı Buharlı / Gas Combination

Neo24  
hours

NEW

- 40°C'den +85°C'ye kadar maksimum esneklik: nasıl kullanacağını-zi siz seçin.
- Yüzlerce otomatik Cook&Chill tarifini kullanarak Lainox'un bilgi birikimine güvenin.
- Çözdürülecek ürünün boyutu ne olursa olsun, sabah kullanıma hazır olacaktır.
- Lainox şeflerinin sizin için hazırladığı yüzlerce tariften ilham alın veya kendi tariflerinizi oluşturup saklayın.
- Neo'ya 24 saat içinde ürününüzün ne zaman mayalanmasını ve pişirilmeye hazır olmasını istediğinizi söyleyin, gerisini o halletsin.

- Maximum flexibility from 40°C to +85°C: you choose how to use it.
- Rely on Lainox's expertise with hundreds of automatic Cook&Chill recipes.
- Regardless of the size of the product to be defrosted, it will be ready for use in the morning.
- Get inspired by hundreds of recipes created by Lainox chefs for you, or create and save your own recipes.
- Tell Neo when you want your product to ferment and be ready to bake within 24 hours, and let it handle the rest.



278

Şok Soğutucu  
Blast Chiller

» Kod Code	Kapasite Capacity	Ölçü (mm) Dim (mm)
63020058	12 Adet 40x60 Tepsi 12 Trays 40x60 Size	790x870x1810

Güç / Power	3,635
Elektrik Girişi / Power Supply Voltage	3N-AC 400 V - 50
Kapasite / Capacity	12 x GN 1/1 - 12 x EN1 (600x400)
Ölçüler / Dimensions	79 x 87 x 18,1

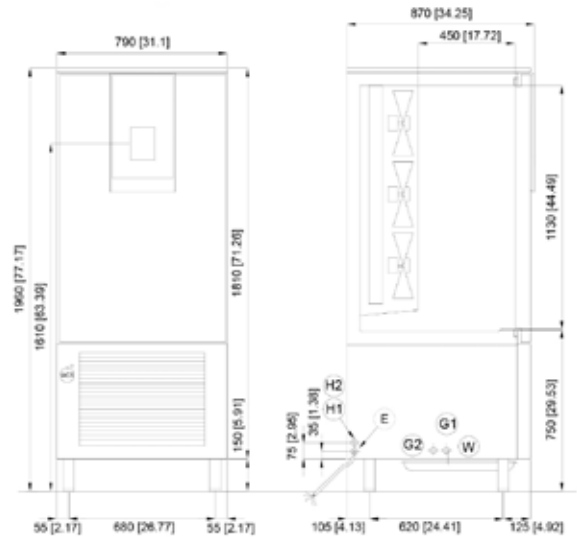

- 100°C ila 300°C arasında sıcaklıklarda konveksiyon, mikrodalga ve çarpma modlarını aynı anda kullanan bir çalışma modu.
- Yüksek Hızlı Fırın modunda yüksek hızlı pişirme için otomatik, denenmiş ve test edilmiş tarifleri kullanarak Lainox'un teknik bilgisine güvenin.
- Oracle, Combi Wave modunda 30°C ila 300°C sıcaklıklarda konveksiyonlu fırın olarak, 2000W'a kadar güce sahip mikrodalga fırın olarak veya iki pişirme yönteminin kombinasyonu ile kullanılabilir ve her zaman beklentileri aşan sonuçlar elde edilebilir.
- Combi Wave modunda pişirme için otomatik, denenmiş ve test edilmiş tarifleri kullanarak Lainox'un bilgi birikimine güvenin.
- Oracle, standart Wi-Fi ve ethernet özellikleri aracılığıyla Lainox'un Nabook plus portalına ücretsiz bağlanarak size 4.0 mutfak sunuyor.

- A working mode that simultaneously uses convection, microwave, and impingement modes at temperatures ranging from 100°C to 300°C.
- Trust Lainox's technical expertise by using automatic, tried, and tested recipes for high-speed cooking in High-Speed Oven mode.
- Oracle can be used as a convection oven at temperatures ranging from 30°C to 300°C in Combi Wave mode, as a microwave oven with power up to 2000W, or as a combination of both cooking methods, always delivering results that exceed expectations.
- Trust Lainox's expertise by using automatic, tried, and tested recipes for cooking in Combi Wave mode.
- Oracle offers you a 4.0 kitchen by connecting to Lainox's Nabook Plus portal for free via standard Wi-Fi and Ethernet features.

NEW



279

### Süper Hızlı Pişirme Fırını Speed Oven



63020057

63040057

Kod Code	Renk Color	Ölçü (mm) Dim (mm)
63030057	Gri / Grey	465x610x630
63040057	Siyah / Black	465x610x630
63020057	Kırmızı / Red	465x610x630

Güç / Power	3,3 kW
Elektrik Girişi / Power Supply Voltage	1N-AC 230 V - 50
Kapasite / Capacity	17,9 lt
Ölçüler / Dimensions	46,5 x 61 x 63 cm

- Paslanmaz çelik gövde
- 2 ızgara ve mikroddalga seçeneği
- Kırılmaz camdan mamül döner tabak
- 30 dak. zaman ayarı
- 25 lt iç hacim
- Mikroddalga: 6 farklı güç seviyesi
- Ağırlık bazlı otomatik buz çözme
- Restaurant ve barlar için ideal
- 340x330xH.220 mm iç hacim
- 900 W çıkış gücü
- Stainless steel construction
- Tempered glass rotating plate
- Timer 30 min.
- Microwave: 6 different power levels
- 2 grill-microwave combination
- Weight-based automatic defrost
- Ideal for small restaurants and bars



Güç / Power

1400 W m.o./1000 W grill

Güç Kaynağı / Power Source

230 V/50 Hz

Güç Kademesi / Power Level

n. 5

Mikroddalga Frekans / Microwave Frequency

MHz 2450

» Kod  
Code

63010055

Model  
ModelMikroddalga Fırın  
Microwave Oven

280

Hazne kapasitesi / Inside Volume

25 Lt

Net Weight / Net Ağırlık

14,5 Kg

Ölçüler / Dimensions

483x422x281 mm

- Paslanmaz çelik kabin
- Cam seramik pişirme tepsi
- 5 ayrı güç seviyesi ile çok yönlü kullanım
- Zaman ve ısı ayarları için manuel kontrol
- 25 lt kapasite
- Restaurant ve barlar için ideal
- 330x360xH.200 mm iç hacim
- High versatility with 5 power levels
- Manual controls for power and timer
- Stainless steel cabinet and cavity finish
- Ceramic glass cooking plate
- See-through opening door with practical handle
- 25 lt inside volume
- Inner dimensions 330x360x200 mm

» Kod  
Code

63010054

Model  
ModelMikroddalga Fırın  
Microwave Oven

Güç / Power

1500 W

Güç Kaynağı / Power Source

230 V/50 Hz

Güç Kademesi / Power Level

n. 6

Mikroddalga Frekans / Microwave Frequency

MHz 2450

Hazne kapasitesi / Inside Volume

25 Lt

Net Weight / Net Ağırlık

17,7 Kg

Ölçüler / Dimensions

520x442x312 mm

Kod Code	Model Model
63010019	İndüksiyon Ocak / Induction Cooker
Güç / Power	3500 W
Güç Kaynağı / Power Source	220-240 V/50-60 Hz
Zamanlayıcı / Timer	0 -180 dk/min
Ölçüler / Dimensions	A B C 330 mm 425 mm 105 mm



- Mutfakta,restoranda,yada yemek odalarında her kullanım yüzeyine uygun kurulumu kolay elektrikli ocak ızgara
- Duman bulundurmaması sayesinde umuma açık yerlerde ya da müşteri önünde pişirim yapmaya son derece elverişlidir
- Derecelendirilmiş dijital kontrol
- Kullanım ve temizlemesi çok kolaydır
- Pürüzsüz pişirme yüzeyi temizlemeyi kolaylaştırmaktadır
- Asla aşırı ısınmayan yüzeyi ile oldukça güvenlidir
- Elektrikli ocak ızgara ısıyı etkin kullanması ve asla aşırı ısınmaması sayesinde enerji tasarrufludur
- Tencere ocak üzerinden alındığında elektrik emilimi durur

- The induction hobs are easy to install on every working surface in kitchens, restaurants or dining rooms; thanks to the absence of fumes they are perfect for public cooking performances or when the preparation is made in view of customers
- Graduated digital controls
- Extremely easy to use and to clean
- Smooth cooking surface makes cleaning easy
- Safe operations are ensured by the cooking surface which is never heating up
- Induction hobs are energy saving thanks to heating efficiency and no need to heat up
- Electric absorption is stopped when the pan is removed from the hob surface

281

Kod Code	Model Model
57103838	Gömme İndüksiyon Ocak / Built-In Induction Cooker
Güç / Power	3500 W
Güç Kaynağı / Power Source	220-240 V/50-60 Hz F + N
Kullanılabilir Alan / Useful Surface	Ø 280 mm
Ölçüler / Dimensions	A B C 360 mm 380 mm 125 mm



- Güçlendirilmiş soğutmalı motor
- Pulse fonksiyonu
- Ayarlanabilir hız
- 2 Litre kapasiteli, bulaşık makinasında yıkanabilir şeffaf hazne
- Dereceli hazne ve sızdırmaz kauçuk kapak
- Paslanmaz çelik 4 başlı bıçak
- Kolay temizlenebilir
- Powerful ventilated motor
- Reinforced cooled motor
- Pulse function
- Adjustable speed
- 2-liter capacity transparent bowl, dishwasher safe
- Graduated bowl with a leak-proof rubber lid
- Stainless steel 4-blade system
- Easy to clean

NEW



282

>> Kod  
Code

64020011



Güç / Power	2000 W
Güç Kaynağı / Power Source	220V~240V, 50/60Hz
Motor / Motor	r.p.m. 14.000+24.000
Hazne Kapasitesi / Jug Capacity	2 Lt
Net Ağırlık / Net Weight	5,9 Kg
Ölçüler / Dimensions	A B C 230 mm 245 mm 465 mm



- Brushless motor;  
Daha yüksek verimlilik  
Daha hızlı hızlanma  
Daha dayanıklı  
Daha az gürültü
- Brushless motor sayesinde uzun ömürlü kullanım
- 1,5 Litre kapasiteli, bulaşık makinasında yıkanabilir şeffaf hazne
- Sızdırmaz kauçuk kapak
- Ses geçirmez hazne
- Paslanmaz çelik 4 başlı bıçak
- Kademeli hız ayar seçeneği
- Pulse düğmesi Brushless motor sayesinde motoru zorlamaz
- Zamanlayıcı
- Brushless motor;  
Higher efficiency  
Faster speed acceleration  
More durable  
Less Noise
- Long-lasting use thanks to the brushless motor
- 1.5-liter capacity, dishwasher-safe transparent container
- Leakproof rubber lid
- Noise-proof container
- Stainless steel 4-blade system
- Adjustable speed settings
- Pulse button prevents motor strain thanks to the brushless motor
- Timer

NEW



283

» Kod  
Code

64020012

Model  
Model

Ses Geçirmez Hazneli /w/Sound Enclosure

**Brushless DC MOTOR**

Brushless DC motorların Universal ve fırçalı DC motorlara göre en önemli avantajlarından biri, dönme hızı arttığında tork gücünün azalmamasıdır. Bu avantaj, blenderin sağladığı güçlü kuvvet sayesinde kullanıcıların çalışma sürelerini kısaltmalarını sağlar.

One of the most significant advantages of brushless DC motors compared to universal and brushed DC motors is that the torque does not decrease as the rotational speed increases. This advantage allows users to reduce their working time thanks to the strong force provided by the blender.

Güç / Power	2000 W
Güç Kaynağı / Power Source	220V~240V, 50/60Hz
Motor / Motor	Brushless 9540
Hız / Speed	35000-40000 RPM/Min
Hazne Kapasitesi / Jug Capacity	1,5 Lt
Net Ağırlık / Net Weight	8,4 Kg
Ölçüler / Dimensions	A B C 235 mm 280 mm 480 mm

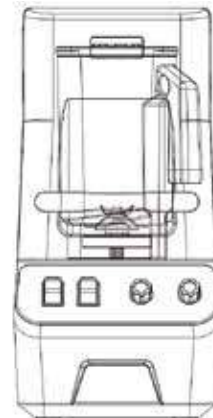

- Güçlendirilmiş soğutmalı motor
- 20 adet ön-ayarlamalı program
- 9 adet özel ayarlanabilir program seçeneği
- Program akışını ve makinenin çalışmasını görüntüleyen ekran
- 2 Litre kapasiteli, bulaşık makinasında yıkanabilir şeffaf hazne
- Dereceli hazne ve sızdırmaz kauçuk kapak
- Paslanmaz çelik 4 başlı bıçak
- Pratik kullanım için 3 ayrı noktadan dökme imkanı
- Frozen ve Smoothie içecekler hazırlamak için mükemmel uyum

- 20 pre-set programs, of which 4 can be linked to 4 keys on the keypad and the other 16 can be recalled through the menu (all can be reprogrammed)
- 9 programs set in self-learning mode
- Display to view the programs and machine operation
- The square glass has been developed to ideally work with large quantities of ice, even dry
- 2 litre capacity, built out of transparent, indestructible Tritan, can be washed in dishwasher, graduated in litres, UK and U.S. gallons
- Glass lid in rubber with airtight seal with cap and graduated glass
- Knife support in stainless steel that can be fully and easily disassembled from the glass body. Knife with 4 spokes obtained from a single mould in tempered cutlery steel, easy to disassemble

Soğutmalı Motor  
Ventilated Motor

» Kod  
Code

63010040  
63020015

Model  
Model

Kare Hazneli / Square Jug  
Ses Geçirmez Kare Hazneli / Square Jug w/Sound Enclosure



Güç / Power

750 W - Hp 1

Güç Kaynağı / Power Source

230 V/50-60 Hz F + N

Motor / Motor

r.p.m. 14.000 + 24.000

Hazne Kapasitesi / Jug Capacity

2 Lt

Net Ağırlık / Net Weight

5 Kg

Ölçüler / Dimensions

A B C D E F G H  
200 mm 200 mm 485 mm 240 mm 230 mm 535 mm 315 mm 670 mm

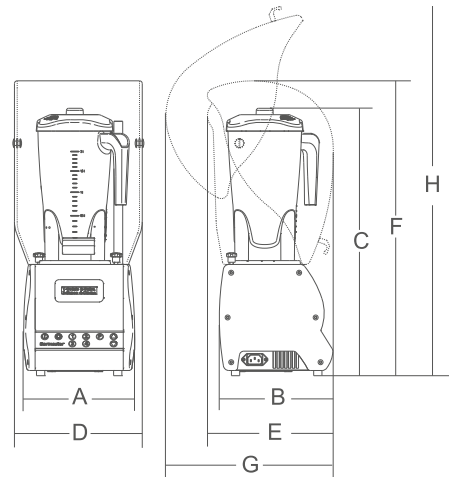

- Güçlendirilmiş soğutmalı motor
- Mekanizmadaki sert kauçuk sayesinde sessiz çalışma
- Kapakta mıknatıslı güvenlik kilidi
- Hız kontrollü açma kapama düğmesi
- 2 Litre kapasiteli, bulaşık makinasında yıkanabilir şeffaf hazne
- Cam hazneden kolayca ayrılabilen paslanmaz çelik bıçak desteği
- Paslanmaz çelik 4 başlı bıçak
- Machine structure in extruded aluminium and sides in ABS with 1 or 2 glasses for the aluminium version and machine structure in stainless steel for the stainless steel version
- Powerful motor with forced ventilation, for prolonged use and enhanced durability
- Reliable low-noise transmission system in vulcanized rubber
- Magnetic safety micro-switch on glass lid without forced position
- 2 litre capacity, built out of transparent, indestructible Tritan, can be washed in dishwasher, graduated in litres, UK and U.S. gallons, or 2 litre and 5 litre glass in stainless steel for the Five version
- Glass lid in rubber or polyester for Orion Five, both with airtight seal with cap and graduated glass
- Knife support in stainless steel that can be fully and easily disassembled from the glass body

**Soğutmalı Motor**  
*Ventilated Motor***>> Kod**  
Code**Model**  
Model

63010014

Yuvarlak Hazneli / Round Jug

63010041

Ses Geçirmez Yuvarlak Hazneli / Round Jug w/Sound Enclosure

285

**Volkanize kauçuk mekanizma**  
*Vulcanized rubber gears***Milkshake aparatı**  
*Milkshake application***Güç / Power**

750 W - Hp 1

**Güç Kaynağı / Power Source**

230 V/50-60 Hz F+N

**Motor / Motor**

r.p.m. 14.000+24.000

**Hazne Kapasitesi / Jug Capacity**

2 Lt

**Net Ağırlık / Net Weight**

5 Kg

**Ölçüler / Dimensions**

A	B	C
200 mm	200 mm	470 mm

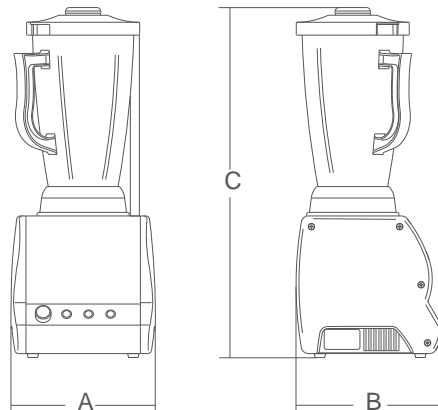

- Yüksek güçlü, soğutmalı motor
- Şeffaf, 1,5 Litrelik, bulaşık makinesinde yıkanabilen hazne
- Çalışma esnasında malzeme eklemeye uygun sızdırmaz kapak
- Sertleştirilmiş kauçuk dişliler ile yüksek güç iletimi ve sessiz çalışma
- 4 parçalı sökülebilir paslanmaz çelik bıçak
- Kapakta emniyet kilidi
- Powerful ventilated motor
- Transparent, unbreakable 1,5 Lt Tritan container is dishwasher safe and graduated with litres and gallons
- Tight rubber lid with feed opening to add ingredients while the blender is working
- Vulcanized rubber gears drive gives a high power transmission and quiet operation
- 4-blades stainless steel knife can be easily disassembled
- Safety microswitch on the lid



Soğutmalı Motor  
Ventilated Motor



Güç / Power	450 W - Hp 0,60
Güç Kaynağı / Power Source	230 V 50/60 Hz F+N
Motor / Motor	r.p.m. 18.000
Hazne Kapasitesi / Jug Capacity	0,55 Lt
Net Ağırlık / Net Weight	3 Kg
Ölçüler / Dimensions	213x200x416 mm

>> Kod Code	Model Model
63010013	Blender



- Şeffaf 550 cc Tritan hazne
- Daha uzun ömür için soğutmalı motor
- Kokteyl ya da içecek hazırlamak için üç alüminyum pimli ve paslanmaz çelik başlıklı karıştırıcı ya da donmuş kahve veya kremli sonuçlar için özel yuvarlak karıştırıcı
- Hazne mekanizmasında güvenlik kilidi

- Transparent 550 cc Tritan cup or stainless steel cup on request
- 900 cc stainless steel cup on 120 W version
- Powerful ventilated motor for a longer life
- Spindle with three aluminium and s/steel agitators for preparing cocktails and drinks, or with a special round agitator for frozen coffees or for creamier results
- Safety microswitch on the cup support

Güç / Power	100 W
Güç Kaynağı / Power Source	230 V 50/60 Hz F+N
Motor / Motor	r.p.m. 14.000
Hazne Kapasitesi / Jug Capacity	0,55 Lt
Net Ağırlık / Net Weight	2,5 Kg
Ölçüler / Dimensions	150x195x485 mm

>> Kod Code	Model Model
63010011	İçecek Mikseri / Beverage Mixer

- Yuvarlak tasarımlı , ticari kullanıma uygun
- Krom gövde, kolay temizlik için köşesiz ve eksiz tasarım
- Sökülebilir paslanmaz çelik hazne kolay temizlenebilir ve bulaşık makinasında kullanıma uygun
- Maksimum verimlilik için tek parça sıkacak ve süzgeç
- Gıda temasını önlemek için alüminyum paslanmaz çelik seviye ayarlayıcı
- Meyve aşağı itildiğinde cihazın çalışmasını sağlayan patentli güvenlik şalteri
- Commercial easy to use citrus juicer with round design
- Chrome body, no edges or seams for easy cleaning
- Stainless steel bowl is removable for cleaning and is dishwasher safe, ABS bowl available on request
- Reamer and sieve are one piece to squeeze with the maximum efficiency
- Aluminium stainless steel lever to avoid any food contact is available on request
- Patented safety microswitch on the cone allows to activate the juicer when the product is pushed down
- The juicer is available without microswitch as well
- Speed control on request



» Kod  
Code  
63010016

Model  
Model

Narenciye Sıkacağı / Citrus Juicer

Güç / Power	150 W
Güç Kaynağı / Power Source	230 V /50-60 Hz F + N
Devir/Dakika / Revolutions/min.	r.p.m. 320
Net Ağırlık / Net Weight	3 Kg
Ölçüler / Dimensions	210x210x280 mm



» Kod  
Code  
63010017

Model  
Model

Narenciye Sıkacağı Kapaklı / Citrus Juicer w/Lever

- Yuvarlak tasarımlı , ticari kullanıma uygun
- Krom gövde, kolay temizlik için köşesiz ve eksiz tasarım
- Sökülebilir paslanmaz çelik hazne kolay temizlenebilir ve bulaşık makinasında kullanıma uygun
- Maksimum verimlilik için tek parça sıkacak ve süzgeç
- Gıda temasını önlemek için alüminyum paslanmaz çelik seviye ayarlayıcı
- Meyve aşağı itildiğinde cihazın çalışmasını sağlayan patentli güvenlik şalteri
- İsteğe bağlı hız kontrolü
- Mikroanahtarsız sıkıcı da mevcuttur

- Commercial easy to use citrus juicer with round design
- Chrome body, no edges or seams for easy cleaning
- Stainless steel bowl is removable for cleaning and is dishwasher safe, ABS bowl available on request
- Reamer and sieve are one piece to squeeze with the maximum efficiency
- Aluminium stainless steel lever to avoid any food contact is available on request
- Patented safety microswitch on the cone allows to activate the juicer when the product is pushed down
- The juicer is available without microswitch as well
- Speed control on request

Güç / Power	150 W
Güç Kaynağı / Power Source	230 V /50-60 Hz F + N
Devir/Dakika / Revolutions/min.	r.p.m. 320
Net Ağırlık / Net Weight	3,5 Kg
Ölçüler / Dimensions	210x210x280 mm

- Çekme alüminyum iskelet, ABS gövde
  - Kuru buz için ideal
  - Buz kalınlığı ayarlama
  - Buzu direk bardağa dökebilme kolaylığı
  - Mikroswitch kapaklı paslanmaz çelik 3 lt hazne
  - 800 r.p.m. (devir)
  - Bronzdan imal dişli motor redüktörü
- Professional ice crusher, an indispensable bar tool for preparing drinks and frozen cocktails and in the restaurant for displaying fish or fresh foods
  - Crushes any ice cubes made with an ice cube machine up to 40x40mm at -3° C
  - Its discharge adjustment lets you regulate the average size of the crushed ice
  - Extruded aluminium body, stainless steel container, food-grade ABS opening and s/steel blades
  - Ventilated motor with gear transmission for prolonged use, micro-switch on the lid for maximum operator safety



» Kod  
Code

63010039

Model  
Model

Buz Kırıcı / Ice Crusher

Güç / Power	150 W
Güç Kaynağı / Power Source	230 V 50/60 Hz F+N
Bıçak Hızı / Blade Speed	r.p.m. 800
Hazne Kapasitesi / Jug Capacity	3 Lt
Net Ağırlık / Net Weight	5,2 Kg
Ölçüler / Dimensions	205x285x491 mm

288



» Kod  
Code

63010018

Model  
Model

Buz Kırıcı / Ice Crusher

- Triton bıçağı ayarlamayla buzı farklı boyutlarda kırmayı sağlar
- Geleneksel İtalyan granitası için düzgün kırılmış buz
- Buzlu kokteyller veya soğuk mezelerin servis ve sunumu için kar buzları
- Besleme ağzında mikro güvenlik anahtarı
- Toplama haznesinde mikro güvenlik anahtarı
- Polisajlı alüminyum besleme ağız
- Paslanmaz çelik parça ve ayrıntılar
- Alüminyum ve paslanmaz çelik iç yapı
- Termo formülü gıdaya uygun plastikten gövde ve hazne
- Düşük emiş gücü için oluklu kayış

- Triton allows to crush ice in different sizes by adjusting the blade:
  - Finely crushed ice for the traditional Italian granitas
  - Flakes for frozen cocktails or to serve or display cold dishes
- Safety microswitch on the feeding mouth
- Safety microswitch on the collecting tray
- Polished aluminium feeding mouth
- Stainless steel parts and details
- Aluminium and stainless steel internal structure
- Body and tray are made from thermoformed alimentary plastic
- Ribbed belt for low power absorption.

Güç / Power	350 W
Güç Kaynağı / Power Source	230 V/50-60 Hz
Motor / Motor	r.p.m. 12000
Bıçak Hızı / Blade Speed	r.p.m. 1500
Max. Buz Kalınlığı / Crushed Ice Max. Thickness	10 mm
Hazne Kapasitesi / Jug Capacity	2 Lt
Net Ağırlık / Net Weight	8,5 Kg
Ölçüler / Dimensions	365x210x465 mm

- Ekolojik yaşamı destekler
- Sağlıklı kızartma seçeneği
- Her filtrasyonda % 50 yağ tasarruf edin
- Gıda'ya uygun malzemelerden üretilmiştir
- Uzun kullanıma sahip özel imal edilmiş paslanmaz çelik filtre
- Kolay temizlenebilir filtre, bulaşık makinasında kolayca yıkanabilme özelliği
- Filtre 316 kalite paslanmaz çelikten imal edilmiştir ve kullanım ömrü 18 aydır
- Kullanım süresinde 110 - 130 LT yağı filtre eder
- 200 C sıcaklığa kadar kullanım kolaylığı
- Dakikada 30 lt filtreleme
- Zaman ayarlı çalışma sistemi
- Akü ile kullanım kolaylığı ve şarj edilebilme özelliği
- İş yeri ve kullanıcı güvenliği için akülü tasarlanmıştır
- Daha az temizlik süresi
- Daha az işçilik

- Supports ecological life
- Take a healthy fry
- Save 50% oil per filtration
- Made for food according 304 quality stainless steel material
- Long life stainless steel filter
- Easy clean filter in dishwasher
- Filter material 316 quality stainless steel and life of the filter 18 month
- 110/130 lt do filtration while operation time
- Operating temperature up to 200 °C
- Filters 30 liters per minute
- Working system with timer
- Wireless working easy system and rechargeable battery
- Designed with battery for work- safety
- Save operation time
- Save working time

NEW



289

» Kod  
CodeModel  
Model

65000110

Yağ Filtreleme Makinesi / Oil Filter Machine

Güç / Power	350 W
Güç Kaynağı / Power Source	220 V
Motor / Motor	r.p.m. 12000
Kullanım süresi / Operation time	4 dk/min
Emiş derinliği / Filtration depth	26 cm
Filtre Ağırlığı / Filter Weight	1,25 Kg
Net Ağırlık / Net Weight	9,6 Kg
Ölçüler / Dimensions	126x205x620 mm





# Taşıma/Carrying

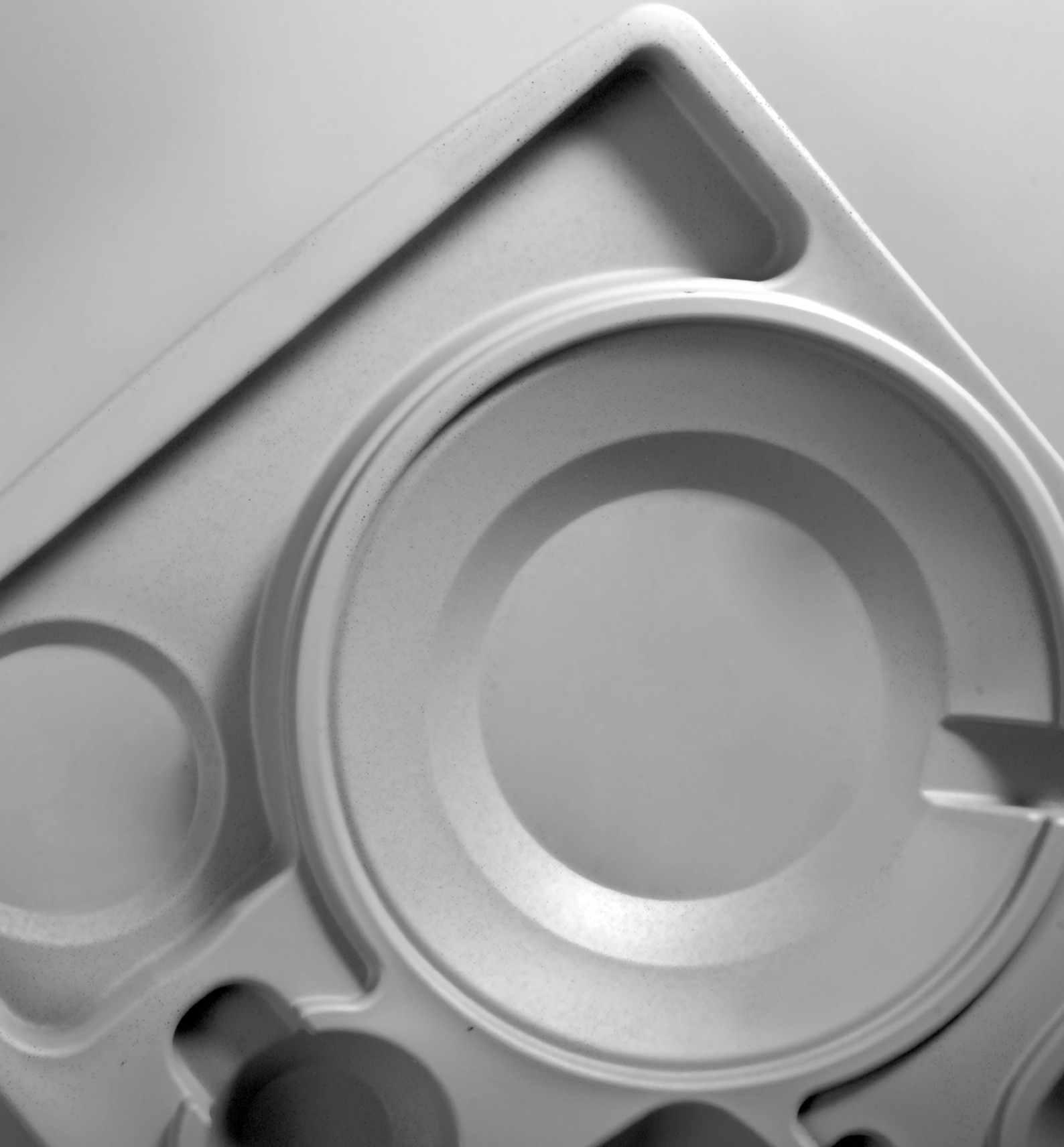

**NEW****Thermocase<sup>®</sup> P600ME** CE

292

Güç / Power	1000 W
Güç Kaynağı / Power Source	220-230 V
Maks. Sıcaklık / Max. Temp.	74°C
Maks. Sıcaklığa Ulaşma / Reaching Max. Temp.	4 dk./mins.
Net Ağırlık / Net Weight	17,5 Kg
İç Ölçüler / Internal Dimensions	33 x 52 x 50 cm
Dış Ölçüler / External Dimensions	44 x 73 x 63 cm



» Thermobox Monteseli Elektrikli P600ME  
Termobox Electrical 600ME (Side-Hinged)

Kod Code	Koli/Adet Pcs/Ctn
46012600	1



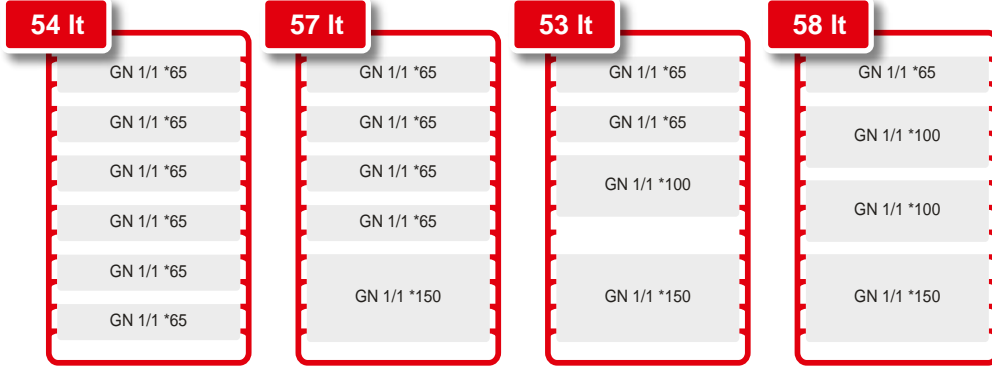

245 Porsiyon  
245 Portions

260 Porsiyon  
260 Portions

240 Porsiyon  
240 Portions

265 Porsiyon  
265 Portions

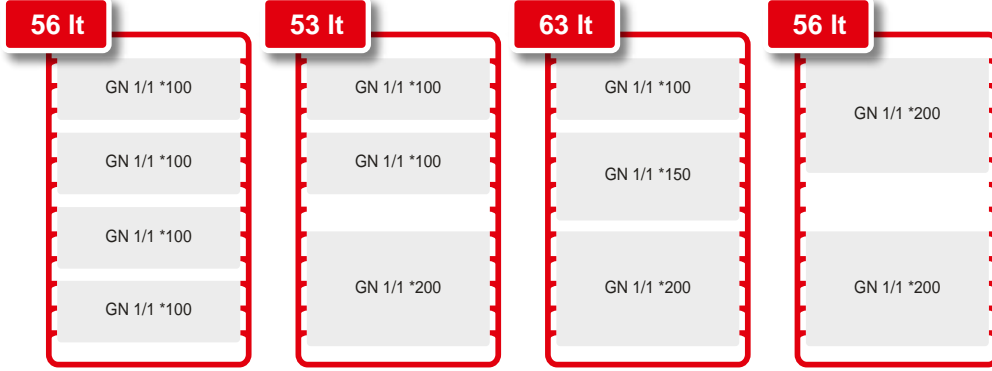

255 Porsiyon  
255 Portions

240 Porsiyon  
240 Portions

290 Porsiyon  
290 Portions

255 Porsiyon  
255 Portions

NEW

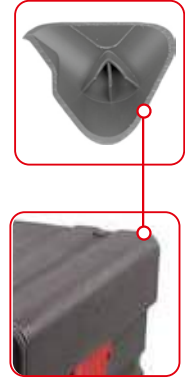

Ekstra güçlendirilmiş kenarlar 293  
Extra Reinforced Edges



### ÜRÜN ÖZELLİKLERİ

- 1 Yalnızca gövde bulaşık makinasında yıkanabilir.
- 2 +100°C sığağa,-40°C soğuşa dayanıklıdır.
- 3 Ürün iç yüzeyinin kolay temizlenebilmesi ve hijyenik olabilmesi için parlak ve pürüzsüzdür.
- 4 Ekstra güçlendirilmiş köşe yapısına sahiptir.
- 5 53 Lt - 63 Lt arasında taşıma kapasitesine sahiptir.
- 6 Hafif gövde yapısı sayesinde taşıma kolaylığı sağlar.
- 7 Üst üste dizilebilir.
- 8 Çift cidarlıdır. Cidarlar arasında poliüretan köpük kullanılmıştır.
- 9 İnsan sağlığına zararlı madde içermemektedir.
- 10 Talebe göre renk seçenekleriyle üretilebilir.

### PRODUCT FEATURES

- 1 Only the trunk is dishwasher safe
- 2 Can withstand temperatures from -40°C +100°C
- 3 Smooth inside surface that is hygienic and easy to clean
- 4 Features tough reinforced corners
- 5 Can carry from 53 to 63 Lt
- 6 Light case that is easy to lift
- 7 Stackable
- 8 Double walls filled with polyurethane foam
- 9 Does not contain any substances harmful to human health
- 10 Other colors available upon request



## Thermocase® P600M

» Thermobox 600 Menteseli  
Thermobox 600 (Side-Hinged)

Kod Code	Koli/Adet Pcs/Ctn
46011600	1

294



## Thermocase® P600

» Thermobox 600  
Thermobox 600

Kod Code	Koli/Adet Pcs/Ctn
46010600	1

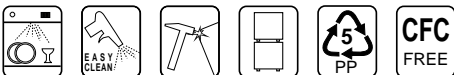

 \*Renk Seçenekleri  
\*Colour options



\* Önden yüklemeli model. Max. GN 1/1 küvet kullanımına uygundur.  
\* Front loading model. Designed for GN Food Pan Standards.

**GN 1/1 YÜKLEME SEÇENEKLERİ / GN 1/1 TRAY LOADING OPTIONS**

<p><b>54 lt</b></p> <p>GN 1/1 *65</p> <p>GN 1/1 *65</p> <p>GN 1/1 *65</p> <p>GN 1/1 *65</p> <p>GN 1/1 *65</p> <p>GN 1/1 *65</p> <p>245 Porsiyon 245 Portions</p>	<p><b>57 lt</b></p> <p>GN 1/1 *65</p> <p>GN 1/1 *65</p> <p>GN 1/1 *65</p> <p>GN 1/1 *65</p> <p>GN 1/1 *150</p> <p>260 Porsiyon 260 Portions</p>	<p><b>53 lt</b></p> <p>GN 1/1 *65</p> <p>GN 1/1 *65</p> <p>GN 1/1 *100</p> <p>GN 1/1 *150</p> <p>240 Porsiyon 240 Portions</p>	<p><b>58 lt</b></p> <p>GN 1/1 *65</p> <p>GN 1/1 *100</p> <p>GN 1/1 *100</p> <p>GN 1/1 *150</p> <p>265 Porsiyon 265 Portions</p>
<p><b>56 lt</b></p> <p>GN 1/1 *100</p> <p>GN 1/1 *100</p> <p>GN 1/1 *100</p> <p>GN 1/1 *100</p> <p>255 Porsiyon 255 Portions</p>	<p><b>53 lt</b></p> <p>GN 1/1 *100</p> <p>GN 1/1 *100</p> <p>GN 1/1 *200</p> <p>240 Porsiyon 240 Portions</p>	<p><b>63 lt</b></p> <p>GN 1/1 *100</p> <p>GN 1/1 *150</p> <p>GN 1/1 *200</p> <p>290 Porsiyon 290 Portions</p>	<p><b>56 lt</b></p> <p>GN 1/1 *200</p> <p>GN 1/1 *200</p> <p>255 Porsiyon 255 Portions</p>

**ÜRÜN ÖZELLİKLERİ**

- 1 Bulaşık makinasında yıkanabilir.
- 2 +100°C sığağa,-40°C soğuga dayanıklıdır.
- 3 Ürün iç yüzeyinin kolay temizlenebilmesi ve hijyenik olabilmesi için parlak ve pürüzsüzdür.
- 4 Ekstra güçlendirilmiş köşe yapısına sahiptir.
- 5 53 lt - 63 lt arasında taşıma kapasitesine sahiptir.
- 6 Hafif gövde yapısı sayesinde taşıma kolaylığı sağlar.
- 7 Üst üste dizilebilir.
- 8 Çift cidarlıdır. Cidarlar arasında poliüretan köpük kullanılmıştır.
- 9 İnsan sağlığına zararlı madde içermemektedir.
- 10 Talebe göre renk seçenekleriyle üretilebilir.



Ekstra güçlendirilmiş köşe yapısı  
Extra Reinforced Edges

**PRODUCT FEATURES**

- 1 Dishwasher safe
- 2 Can withstand temperatures from -40°C +100°C
- 3 Smooth inside surface that is hygienic and easy to clean
- 4 Features tough reinforced corners
- 5 Can carry from 53 to 63 lt
- 6 Light case that is easy to lift
- 7 Stackable
- 8 Double walls filled with polyurethane foam
- 9 Does not contain any substances harmful to human health
- 10 Other colors available upon request

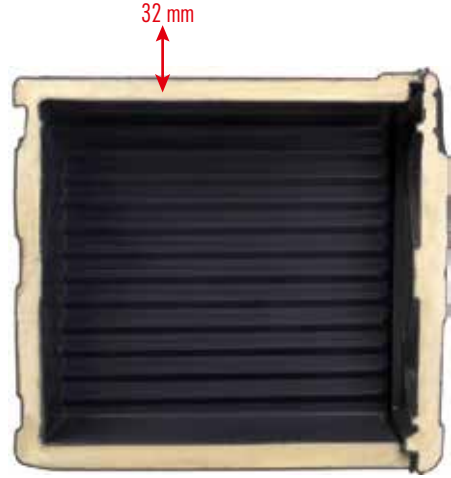
**ÖLÇÜLER / DIMENSIONS P600**

İç Ölçüler / Internal Dimensions	33x52x50 cm
Dış Ölçüler / External Dimensions	44x66x63 cm
Ağırlık / Weight	13.5 kg

**ÖLÇÜLER / DIMENSIONS P600M**

İç Ölçüler / Internal Dimensions	33x52x50 cm
Dış Ölçüler / External Dimensions	44x66x63 cm
Ağırlık / Weight	14 kg

**TESTLER / TESTS**

4 adet 10 cm derinlikte küvetlerde 88°C lik sıcak su ve 0,5 °C lik soğuk su ile test edilmiştir.  
Tested with four deep trays filled with hot water at 88 °C and cold water 0,5 °C

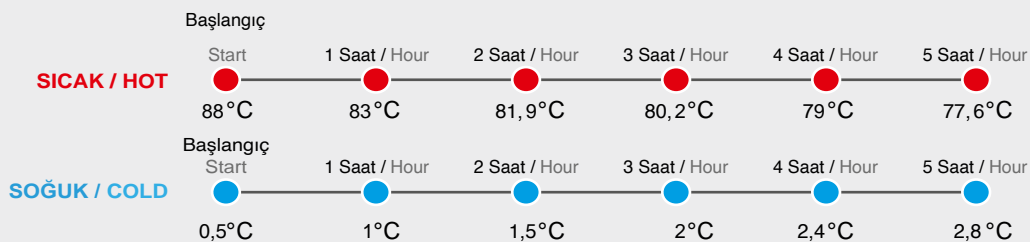



» Thermobox ve Basket Taşıma Arabası Kulplu  
Thermobox and Basket Trolley w/handle

Kod Code	Ölçü (cm) Dim. (cm)	Koli/Adet Pcs/Ctn
46011001	90x60x22	1



Thermobox'ın özel kilit mekanizması  
devrilmeden taşımaya sağlar  
*Thermobox's special locking mechanism  
ensures transportation without tipping over.*



Thermobox'ın özel kilit mekanizması  
devrilmeden taşımaya sağlar  
*Thermobox's special locking mechanism  
ensures transportation without tipping over.*

NEW



» Thermobox ve Basket Taşıma Arabası  
Thermobox and Basket Trolley

Kod Code	Ölçü (cm) Dim. (cm)	Koli/Adet Pcs/Ctn
46011000	90x60x22	1

297



Katlanabilir tutma kolu  
*Foldable handle*



Özel kilit sistemi ile güvenli taşıma  
*Safe transportation with a special lock system*



Üst üste istiflenebilir tasarım yer tasarrufu sağlar  
*Stackable design saves space*



» İçecek Thermobox  
Beverage Thermobox

Kod Code	Lt Lt	Koli/Adet Pcs/Ctn
43020300	23	1



» Yiyecek & İçecek Thermobox  
Food & Beverage Thermobox

Kod Code	Lt Lt	Koli/Adet Pcs/Ctn
43020250	33	1

298



\* Üstten yüklemeli model. Max. GN 1/1 kuvvet kullanımına uygundur.  
\* Overhead loading model. Designed for GN Food Pan Standards

» Thermobox  
Standard

Kod Code	Ölçü (mm) Dim. (mm)	Model Model	Koli/Adet Pcs/Ctn
43020100	635x435x200	Max. GN 1/1-100	1
43120100	635x435x200	Max. GN 1/1-100	1
43220100	635x435x200	Max. GN 1/1-100	1
43320100	635x435x200	Max. GN 1/1-100	1
43020150	635x435x250	Max. GN 1/1-150	1
43120150	635x435x250	Max. GN 1/1-150	1
43220150	635x435x250	Max. GN 1/1-150	1
43320150	635x435x250	Max. GN 1/1-150	1
43020200	635x435x310	Max. GN 1/1-200	1
43120200	635x435x310	Max. GN 1/1-200	1
43220200	635x435x310	Max. GN 1/1-200	1
43320200	635x435x310	Max. GN 1/1-200	1

430 431 432 433



\*Aksesuarlar hariçtir  
\*w/o Accessories

» Termo Tepsi  
Isothermic Tray

Kod Code	Ölçü (mm) Dim. (mm)	Model Model	Koli/Adet Pcs/Ctn
43020105	530x370x120	5 Gözlü 5 Partition	1
43020106	530x370x120	6 Gözlü 6 Partition	1



» Sefer Tası Standart

Standard

Kod Code	Øxh (cm) Øxh (cm)	AdxLt Pcs/Lt	Koli/Adet Pcs/Ctn
30631808	18x8x3	3x2	4
30641808	18x8x4	4x2	4
30632010	20x9x3	3x3	4
30642010	20x9x4	4x3	4
30632414	24x14x3	3x6	2
30642414	24x14x4	4x6	2
30633014	30x14x3	3x10	1
30643014	30x14x4	4x10	2



» Sefer Tası İzoleli

Double Wall

Kod Code	Øxh (cm) Øxh (cm)	AdxLt Pcs/Lt	Koli/Adet Pcs/Ctn
35502092	20x11x2	2x3	4
35502093	20x11x3	3x3	4
35502094	20x11x4	3x4	4



» Taşıma Tepsisi Kapaklı

Carrying Tray w/Clip-on Cover

Kod Code	Ölçü Dims. (cm)	Koli/Adet Pcs/Ctn
30714565	40x60x5	2
30714568	40x60x8	2
30714561	40x60x10	2
30715355	50x35x5	2
30715358	50x35x8	2
30715310	50x35x10	2
30715705	50x70x5	3
30715708	50x70x8	3
30715710	50x70x10	3



» Taşıma Tepsisi Kapaksız

Carrying Tray

Kod Code	Ölçü Dims. (cm)	Koli/Adet Pcs/Ctn
30704565	40x60x5	2
30704568	40x60x8	2
30704561	40x60x10	2
30705355	50x35x5	2
30705358	50x35x8	2
30705310	50x35x10	2
30705705	50x70x5	3
30705708	50x70x8	3
30705710	50x70x10	3



» Kapak

Cover

Kod Code	Ölçü Dims. (cm)	Koli/Adet Pcs/Ctn
30705711	40x60	1
30705713	50x35	1
30705712	50x70	1

## Taşıma Kovaları / Carrying Containers



» Tabansız (Kapaklı)  
w/o Sandwich Bottom

Kod Code	Øxh (cm) Øxh (cm)	Lt Lt	Koli/Adet Pcs/Ctn
35512428	24x28	12,5	4
35513028	30x28	20	2
35513032	30x32	21	2
35513636	36x36	36,6	1
35514040	40x40	50	1
35514545	45x45	70	1
35515050	50x50	100	1



» Tabansız (Silikon Conta Kapaklı)  
w/o Sandwich Bottom-Lid w/Silicone Seal

Kod Code	Øxh (cm) Øxh (cm)	Lt Lt	Koli/Adet Pcs/Ctn
35532428	24x28	12,5	4
35533028	30x28	20	2
35533032	30x32	21	2
35533636	36x36	36,6	1
35534040	40x40	50	1
35534545	45x45	70	1

\* Ø36, Ø40, Ø45 ölçüleri sabit saplıdır  
\* Ø36, Ø40, Ø45 has fixed handles



» Tabanlı (Kapaklı)  
w/Sandwich Bottom

Kod Code	Øxh (cm) Øxh (cm)	Lt Lt	Koli/Adet Pcs/Ctn
35502428	24x28	12,5	4
35503028	30x28	20	2
35503032	30x32	21	2
35503636	36x36	36,6	1
35504040	40x40	50	1
35504545	45x45	70	1
35505050	50x50	100	1

\* Ø36, Ø40, Ø45 ölçüleri sabit saplıdır  
\* Ø36, Ø40, Ø45 has fixed handles

300



» Tabanlı (Silikon Conta Kapaklı)  
w/Sandwich Bottom-Lid w/Silicone Seal

Kod Code	Øxh (cm) Øxh (cm)	Lt Lt	Koli/Adet Pcs/Ctn
35542428	24x28	12,5	4
35543028	30x28	20	2
35543032	30x32	21	2
35543636	36x36	36,6	1
35544040	40x40	50	1
35544545	45x45	70	1



» İzoleli  
Double Wall Container

Kod Code	Øxh (cm) Øxh (cm)	Lt Lt	Koli/Adet Pcs/Ctn
35503217	32x17	10	1
35503222	32x22	14	1
35503230	32x30	20	1
35503236	32x36	24	1
35503248	32x48	32	1
35505030	50x30	43	1



» Musluklu  
Container w/Faucet

Kod Code	Øxh (cm) Øxh (cm)	Lt Lt	Koli/Adet Pcs/Ctn
35412428	24x28	12,5	4
35413028	30x28	20	2
35413032	30x32	21	2
35413636	36x36	36,6	1
35414040	40x40	50	1
35414545	45x45	70	1
35415050	50x50	100	1

» Silikon Conta  
Silicone Seals



Kod Code	Ø (cm) Ø (cm)	Koli/Adet Pcs/Ctn
35510024	24	2
35510030	30	2
35510036	36	2
35510040	40	2
35510045	45	2

\* Gıda tüzüğüne uygundur.  
\* Food safe compliances.





Servis Arabası (Açık)  
» Serving Trolley

Kod Code	Ölçü (cm) Dim. (cm)	Koli/Adet Pcs/Ctn
46010028	107x52x96	1

\* Kovalar fiyata dahil değildir. \* Kovalar fiyata dahil değildir.



» Servis Arabası (Kapalı)  
Serving Trolley (Closed)

Kod Code	Ölçü (cm) Dim. (cm)	Koli/Adet Pcs/Ctn
46010027	98x53x93	1



Servis Arabası Kahverengi (Açık)  
» Serving Trolley Brown

Kod Code	Ölçü (cm) Dim. (cm)	Koli/Adet Pcs/Ctn
46110028	107x52x96	1

\* Kovalar fiyata dahil değildir.  
\* Kovalar fiyata dahil değildir.



» Servis Arabası Kahverengi (Kapalı)  
Serving Trolley Brown (Closed)

Kod Code	Ölçü (cm) Dim. (cm)	Koli/Adet Pcs/Ctn
46110027	98x53x93	1



» 5 Katlı Açık Servis Rafı  
Serving Trolley 5 Shelved

Kod Code	Ölçü (cm) Dim. (cm)	Koli/Adet Pcs/Ctn
46011029	160x80x50	1



» 5 Katlı Kapalı Servis Rafı  
Serving Trolley 5 Shelved (Closed)

Kod Code	Ölçü (cm) Dim. (cm)	Koli/Adet Pcs/Ctn
46011030	160x80x50	1



» 2 Katlı Servis Arabası (Demonte)

Demontable Service Trolley

Kod Code	Ölçü (cm) Dim. (cm)	Koli/Adet Pcs/Ctn
34266018	90x60x18	1



» 3 Katlı Servis Arabası (Demonte)

Demontable Service Trolley

Kod Code	Ölçü (cm) Dim. (cm)	Koli/Adet Pcs/Ctn
34266022	90x60x22	1

302



» 3 Katlı Servis Arabası (Monoblok)

Monoblock Service Trolley

Kod Code	Ölçü (cm) Dim. (cm)	Koli/Adet Pcs/Ctn
43010002	98x58,5x88	1

\* Çöp aparatı hariçtir.

\* w/o Waste bin.



» Çöp Kovası

Waste Bin

Kod Code	Ölçü (cm) Dim. (cm)	Koli/Adet Pcs/Ctn
43010011	33,5x23x44,5	2



» Küver Kabı

Cutlery Bin

Kod Code	Ölçü (cm) Dim. (cm)	Koli/Adet Pcs/Ctn
43010012	33,5x23x18	2



» Taşıma Kutusu

Bus Box

Kod Code	Ölçü (cm) Dim. (cm)	Koli/Adet Pcs/Ctn
60020010	54x39x20	2



» Çatal Kaşık Kutusu

4 Compartment Cutlery Holder

Kod Code	Ölçü (cm) Dim. (cm)	Koli/Adet Pcs/Ctn
60020011	52x29x9,5	6

\* Tüm ürünler servis arabaları üzerinde kullanıma uygun ebatlardadır.

\* All products are suitable for serving trolleys.



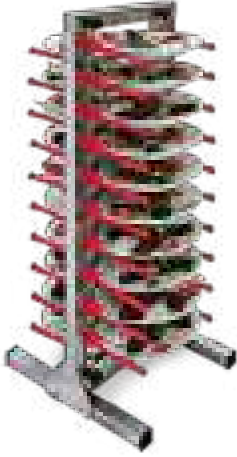

» Tabak İstif Ünitesi  
Table Top Plate Rack

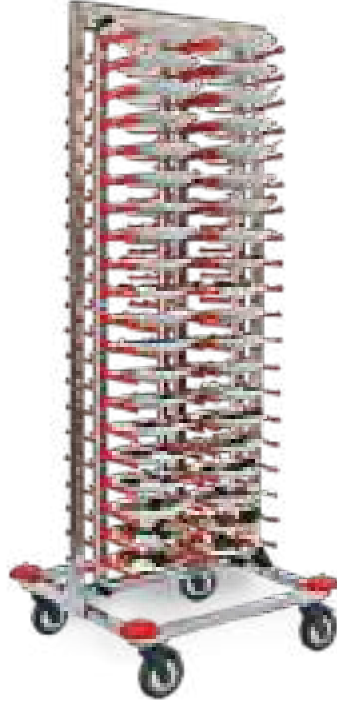

» Tabak İstif Arabası  
Mobile Plate Rack



» Kaset Taşıma Arabası  
Rack Trolley

304

Kod Code	Kapasite Capacity	Koli/Adet Pcs/Ctn
43010015	20 Tabak 20 Plate	1

Kod Code	Kapasite Capacity	Koli/Adet Pcs/Ctn
43010014	80 Tabak 80 Plate	1

Kod Code	Kapasite Capacity	Ölçü (cm) Dim. (cm)	Koli/Adet Pcs/Ctn
48010005	5 Kaset 5 Rails	37x53	1
48010010	10 Kaset 10 Rails	37x53	

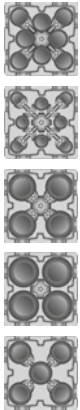

» Tabak Taşıma Arabası Ayarlanabilir  
Adjustable Dish Dolly

Kod Code	Koli/Adet Pcs/Ctn
43010013	1



» Erzak Arabası  
Ingredient Bin w/Sliding Lid

plast|port  
by KAPP

Kod Code	Lt Lt	Ölçü (cm) Dim. (cm)	Koli/Adet Pcs/Ctn
46010010	102	42x75x71	1

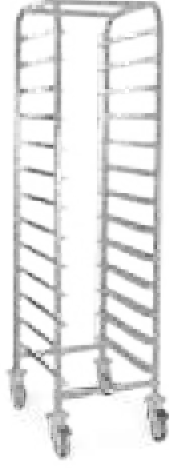

» Bulaşık Toplama Arabası  
Utility Rack

Kod Code	Model Model	Kapasite Capacity	Ölçü (cm) Dim. (cm)	Koli/Adet Pcs/Ctn
48013753	Tekli Single	13 Ad. 37x53 Tepsi 13 Pcs. 37x53 Tray	43x56x171	1
48023753	İkili Double	26 Ad. 37x53 Tepsi 26 Pcs. 37x53 Tray	83x56x171	1
48033753	Üçlü Triple	39 Ad. 37x53 Tepsi 39 Pcs. 37x53 Tray	123x56x171	1
48043753	Dörtlü Quadriple	52 Ad. 37x53 Tepsi 52 Pcs. 37x53 Tray	175x77x171	1



» Tepsi Taşıma Arabası  
Tray Cart

Kod Code	Model Model	Kapasite Capacity	Ölçü (cm) Dim. (cm)	Koli/Adet Pcs/Ctn
48014060	Tekli Single	15 Ad. 40x60 Tepsi 15 Pcs. 40x60 Tray	40x63x165	1
48024060	İkili Double	30 Ad. 40x60 Tepsi 30 Pcs. 40x60 Tray	90x63x165	1
48015070	Tekli Single	15 Ad. 50x70 Tepsi 15 Pcs. 50x70 Tray	56x73x170	1



» Tepsi Taşıma Arabası GN 1/1  
Tray Cart GN 1/1

Kod Code	Model Model	Kapasite Capacity	Ölçü (cm) Dim. (cm)	Koli/Adet Pcs/Ctn
48011009	Tekli Single	9 Ad. GN 1/1 Tepsi 9 Pcs. GN 1/1 Tray	38x56x105	1
48011017	Tekli Single	17 Ad. GN 1/1 Tepsi 17 Pcs. GN 1/1 Tray	38x56x172	1
48011034	İkili Double	34 Ad. GN 1/1 Tepsi 34 Pcs. GN 1/1 Tray	74x56x172	1



» Tepsi Taşıma Arabası GN 2/1  
Tray Cart GN 2/1

Kod Code	Model Model	Kapasite Capacity	Ölçü (cm) Dim. (cm)	Koli/Adet Pcs/Ctn
48012109	Tekli Single	9 Ad. GN 2/1 Tepsi 9 Pcs. GN 2/1 Tray	59x68x105	1
48012117	Tekli Single	17 Ad. GN 2/1 Tepsi 17 Pcs. GN 2/1 Tray	59x68x172	1
48012134	İkili Double	34 Ad. GN 2/1 Tepsi 34 Pcs. GN 2/1 Tray	115x68x172	1

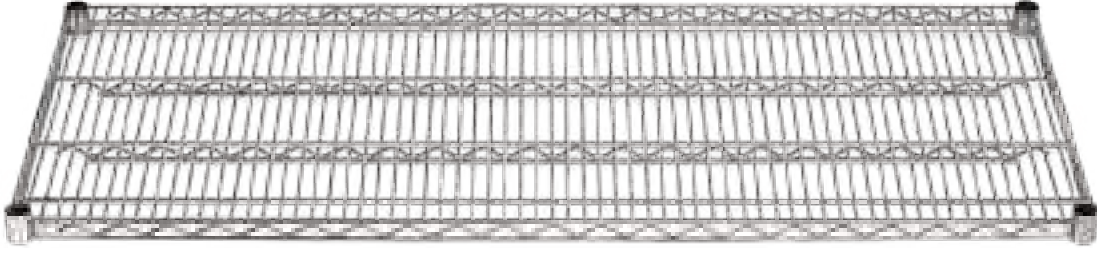

## » Tel Raf

Perforated Shelves

Kod Code	Ölçü (mm) Dim. (mm)	Koli/Adet Pcs/Ctn
50204661	460x610	1
50204676	460x760	1
50204691	460x910	1
50246107	460x1070	1
50246122	460x1220	1
50246137	460x1370	1
50246152	460x1520	1
50246183	460x1830	1

## » Tel Raf

Perforated Shelves

Kod Code	Ölçü (mm) Dim. (mm)	Koli/Adet Pcs/Ctn
50205361	530x610	1
50205376	530x760	1
50205391	530x910	1
50253107	530x1070	1
50253122	530x1220	1
50253137	530x1370	1
50253152	530x1520	1
50253183	530x1830	1

306

## » Tel Raf

Perforated Shelves

Kod Code	Ölçü (mm) Dim. (mm)	Koli/Adet Pcs/Ctn
50206161	610x610	1
50206176	610x760	1
50206191	610x910	1
50261107	610x1070	1
50261122	610x1220	1
50261137	610x1370	1
50261152	610x1520	1
50261183	610x1830	1

## » Yükseltici

Elevator

Kod Code	Ölçü (mm) Dim. (mm)	Koli/Adet Pcs/Ctn
50201800	1800	4



» Tel Raf 4 Katlı

Perforated Shelves w/4 Floor

Kod Code	Ölçü (mm) Dim. (mm)	Koli/Adet Pcs/Ctn
50703661	360x610x1800	1
50703676	360x760x1800	1
50703691	360x910x1800	1
50736107	360x1070x1800	1
50736122	360x1220x1800	1
50736137	360x1370x1800	1
50736152	360x1520x1800	1
50736183	360x1830x1800	1

» Tel Raf 4 Katlı

Perforated Shelves w/4 Floor

Kod Code	Ölçü (mm) Dim. (mm)	Koli/Adet Pcs/Ctn
50704661	460x610x1800	1
50704676	460x760x1800	1
50704691	460x910x1800	1
50746107	460x1070x1800	1
50746122	460x1220x1800	1
50746137	460x1370x1800	1
50746152	460x1520x1800	1
50746183	460x1830x1800	1

» Tel Raf 4 Katlı

Perforated Shelves w/4 Floor

Kod Code	Ölçü (mm) Dim. (mm)	Koli/Adet Pcs/Ctn
50705361	530x610x1800	1
50705376	530x760x1800	1
50705391	530x910x1800	1
50753107	530x1070x1800	1
50753122	530x1220x1800	1
50753137	530x1370x1800	1
50753152	530x1520x1800	1
50753183	530x1830x1800	1

» Tel Raf 4 Katlı

Perforated Shelves w/4 Floor

Kod Code	Ölçü (mm) Dim. (mm)	Koli/Adet Pcs/Ctn
50706161	610x610x1800	1
50706176	610x760x1800	1
50706191	610x910x1800	1
50761107	610x1070x1800	1
50761122	610x1220x1800	1
50761137	610x1370x1800	1
50761152	610x1520x1800	1
50761183	610x1830x1800	1

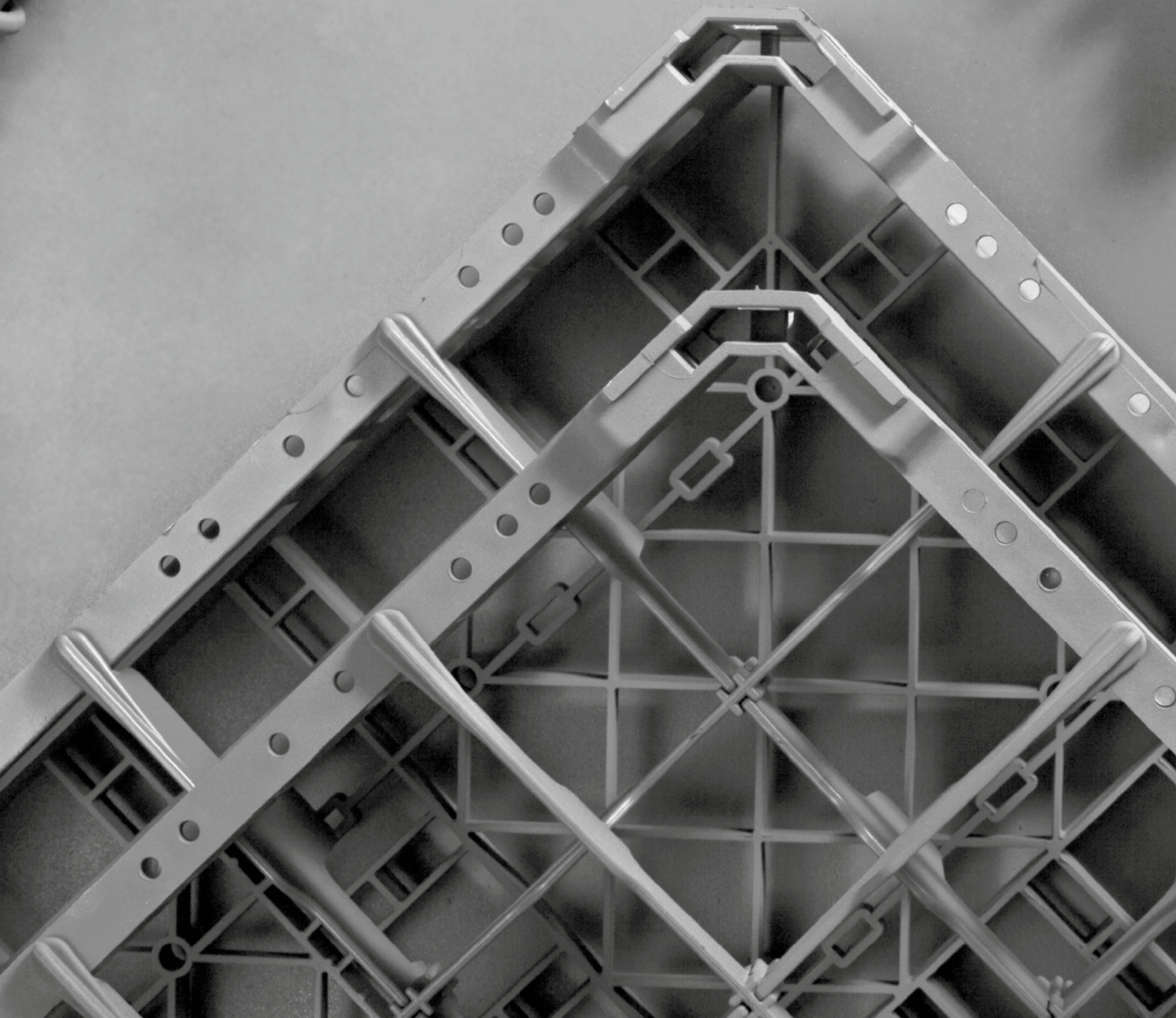

# Bulaşık/Dish Washing

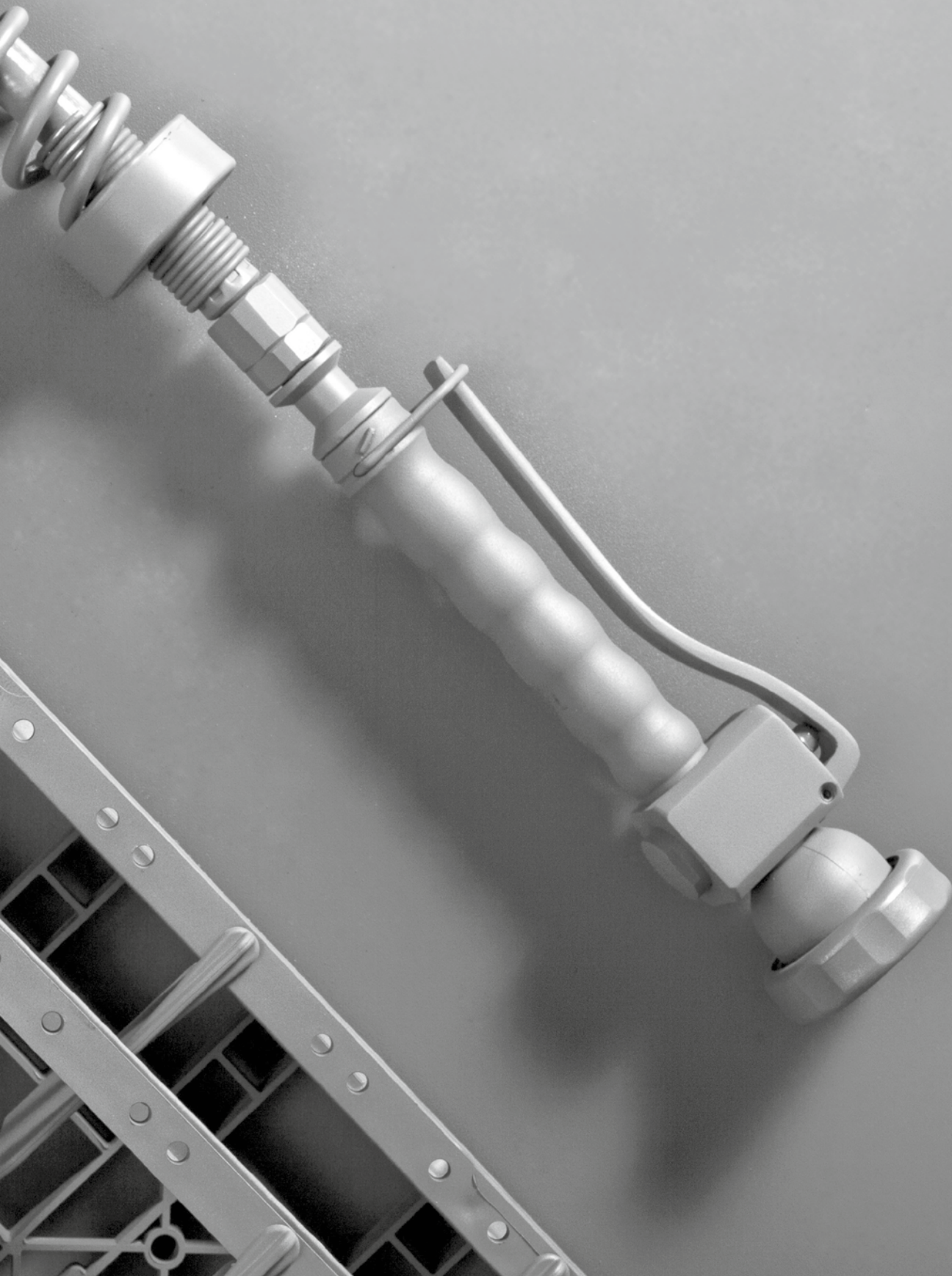

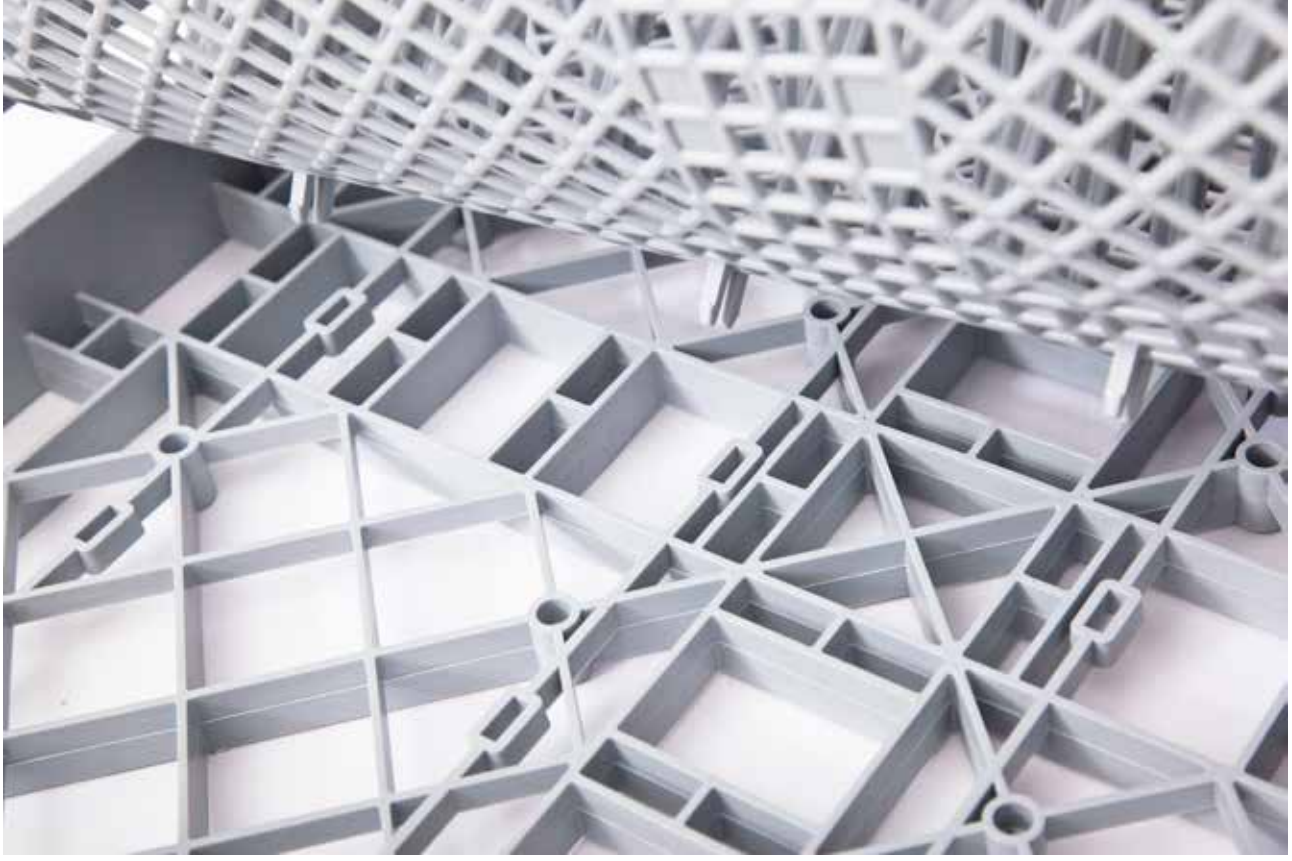

310



» Tabak/Tepsi Basketi  
Plate/Trays Rack

Kod Code	Ölçü (mm) Dim. (mm)	Koli/Adet Pcs/Ctn
43030001	500x500x100	6

» Çatal Kaşık Basketi  
Cutlery Rack

Kod Code	Ölçü (mm) Dim. (mm)	Koli/Adet Pcs/Ctn
43030002	500x500x100	6

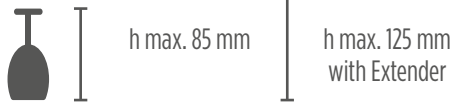

» Düz Bardak Basketi  
Glass Rack

Kod Code	Ölçü (mm) Dim. (mm)	Koli/Adet Pcs/Ctn
43030003	500x500x100	6

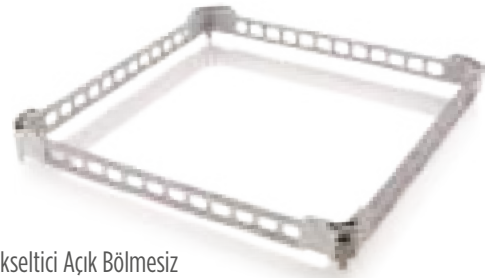

» Yükseltici Açık Bölmesiz  
Open Extender

Kod Code	Ölçü (mm) Dim. (mm)	Koli/Adet Pcs/Ctn
43004006	500x500x40	10

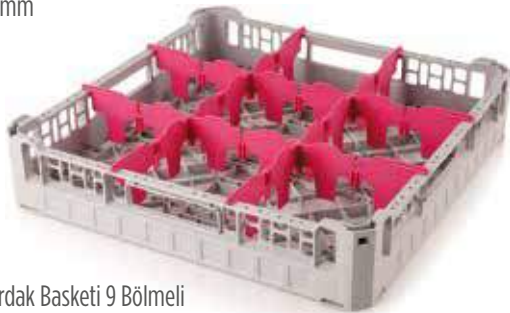

» Bardak Basketi 9 Bölmeli  
9 Compartment Base

Kod Code	Ölçü (mm) Dim. (mm)	Koli/Adet Pcs/Ctn
43003009	500x500x100	6



» Yükseltici 9 Bölmeli  
9 Compartment Extender

Kod Code	Ölçü (mm) Dim. (mm)	Koli/Adet Pcs/Ctn
43004001	500x500x100	10

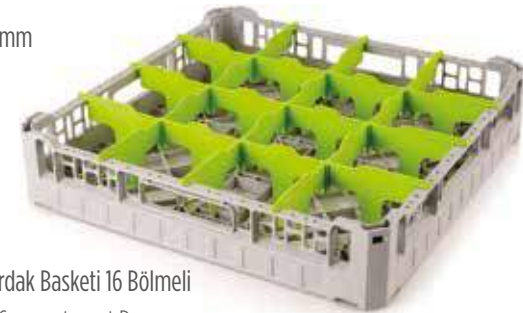

» Bardak Basketi 16 Bölmeli  
16 Compartment Base

Kod Code	Ölçü (mm) Dim. (mm)	Koli/Adet Pcs/Ctn
43003016	500x500x100	6



» Yükseltici 16 Bölmeli  
16 Compartment Extender

Kod Code	Ölçü (mm) Dim. (mm)	Koli/Adet Pcs/Ctn
43004002	500x500x40	10

## Basketler / Dishwasher Racks

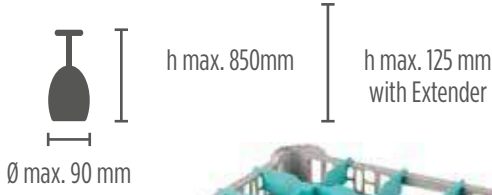

» Bardak Basketi 25 Bölmeli  
25 Compartment Base

Kod Code	Ölçü (mm) Dim. (mm)	Koli/Adet Pcs/Ctn
43003025	500x500x100	6



» Yükseltici 25 Bölmeli  
25 Compartment Extender

Kod Code	Ölçü (mm) Dim. (mm)	Koli/Adet Pcs/Ctn
43004003	500x500x40	10



» Bardak Basketi 36 Bölmeli  
36 Compartment Base

Kod Code	Ölçü (mm) Dim. (mm)	Koli/Adet Pcs/Ctn
43003036	500x500x100	6



» Yükseltici 36 Bölmeli  
36 Compartment Extender

Kod Code	Ölçü (mm) Dim. (mm)	Koli/Adet Pcs/Ctn
43004004	500x500x40	10



» Bardak Basketi 49 Bölmeli  
49 Compartment Base

Kod Code	Ölçü (mm) Dim. (mm)	Koli/Adet Pcs/Ctn
43003049	500x500x100	6

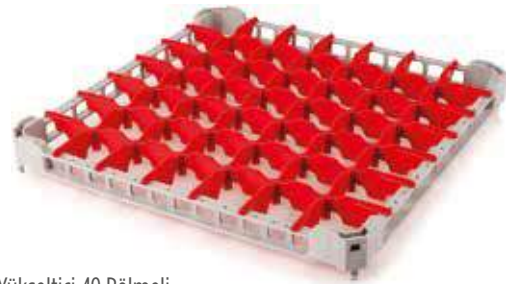

» Yükseltici 49 Bölmeli  
49 Compartment Extender

Kod Code	Ölçü (mm) Dim. (mm)	Koli/Adet Pcs/Ctn
43004005	500x500x40	10



Gövdeden ayrı paketlenen iç seperatörler nakliye esansında avantaj sağlar  
Internal separators can be packaged separately, providing an advantage during transportation

Gövdeden ayrı stoklanabilen seperatörler farklı ürün çeşitlerini stoklamayı kolaylaştırır  
Internal separators separate from the body, provides easy storage for different models

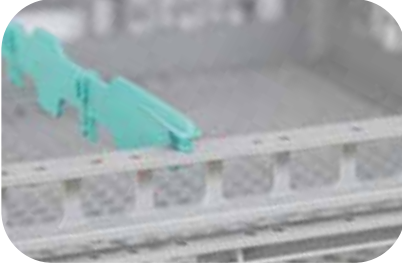

Kolay takılabilir kilit mekanizması  
Easy locking mechanism



Ekstra sağlam kilit mekanizması sayesinde kilitlenen seperatörler takıldıktan sonra tekrar çıkarılamaz  
Separators that locked after installation cannot be removed again thanks to its extra strong locking mechanism

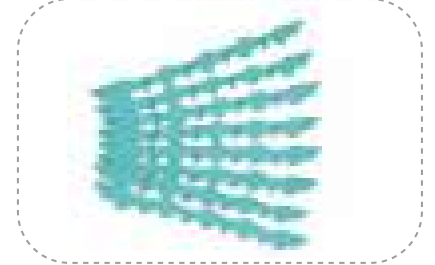

İnce yapraklar halinde paketlenen seperatörler stoklama halinde yerden tasarruf sağlar  
Separators packaged in thin sheets, gives easy storage

313

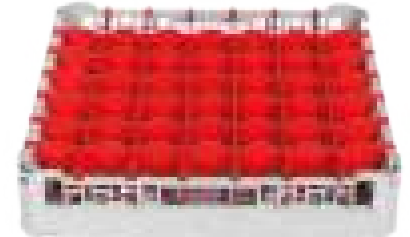
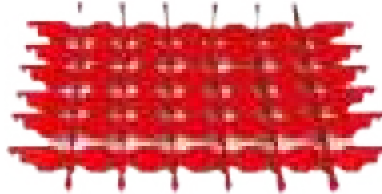
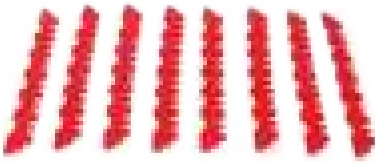

Müşterinin istediği modele göre kolayca birleştirilip kullanıma hazır hale getirilir

It can be easily combined according to the model which desired by the customer



Kolayca takılabilen yükseltici kilit mekanizması  
Easy extender locking mechanism



Yükselticiler üzerindeki ekstra kilit mekanizması  
takıldıktan sonra çıkma riskini ortadan kaldırır  
Extra locking mechanism on extenders  
eliminates the risk of detachment after insertion

Kolayca takılabilen yükselticiler sayesinde  
istenilen yüksekliğe kadar basket yüksekliği ayarlanabilir.

Thanks to the easily attachable extenders,  
the height of the basket can be adjusted to the desired height.

314

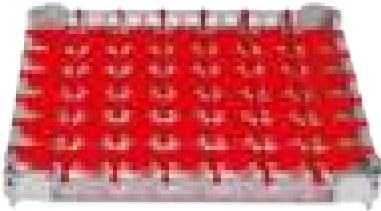

Yükseltici / Extender

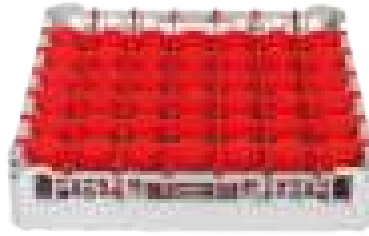

Basket / Base



İlk kat / First level

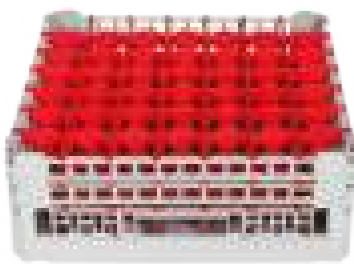

İkinci kat / Second level

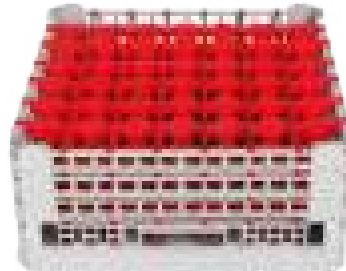

Üçüncü kat / Third level



» Tabak Basketi Aparatı  
Plate/Tray Rack Separator

Kod Code	Ölçü (mm) Dim. (mm)	Koli/Adet Pcs/Ctn
43130001	500x500x100	6

» Çatal Bıçak Basketi Aparatı  
Cutlery Rack Separator

Kod Code	Ölçü (mm) Dim. (mm)	Koli/Adet Pcs/Ctn
43130002	500x500x10	10



» Bardak Basketi Aparatı 9 Bölmeli  
9 Compartment Base Separator

Kod Code	Ölçü (mm) Dim. (mm)	Koli/Adet Pcs/Ctn
43003010	500x500x100	18



» Yükseltici Aparatı 9 Bölmeli  
9 Compartment Extender Separator

Kod Code	Ölçü (mm) Dim. (mm)	Koli/Adet Pcs/Ctn
43004011	500x500x40	24

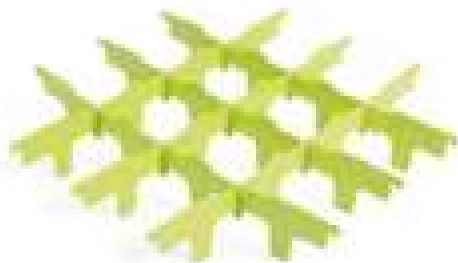

» Bardak Basketi Aparatı 16 Bölmeli  
16 Compartment Base Separator

Kod Code	Ölçü (mm) Dim. (mm)	Koli/Adet Pcs/Ctn
43003017	500x500x100	18



» Yükseltici Aparatı 16 Bölmeli  
16 Compartment Extender Separator

Kod Code	Ölçü (mm) Dim. (mm)	Koli/Adet Pcs/Ctn
43004012	500x500x40	18



» Bardak Basketi Aparatı 25 Bölmeli  
25 Compartment Base Separator

Kod Code	Ölçü (mm) Dim. (mm)	Koli/Adet Pcs/Ctn
43004013	500x500x100	18

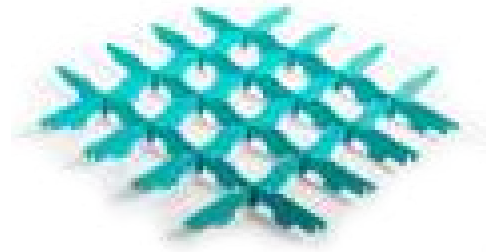

» Yükseltici Aparatı 25 Bölmeli  
25 Compartment Extender Separator

Kod Code	Ölçü (mm) Dim. (mm)	Koli/Adet Pcs/Ctn
43004016	500x500x40	24

316

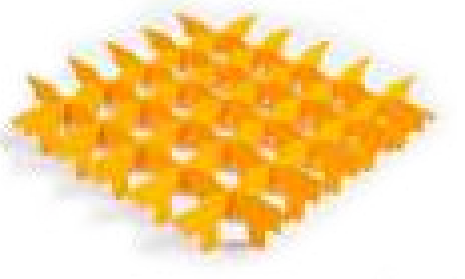

» Bardak Basketi Aparatı 36 Bölmeli  
36 Compartment Base Extender

Kod Code	Ölçü (mm) Dim. (mm)	Koli/Adet Pcs/Ctn
43004014	500x500x100	18

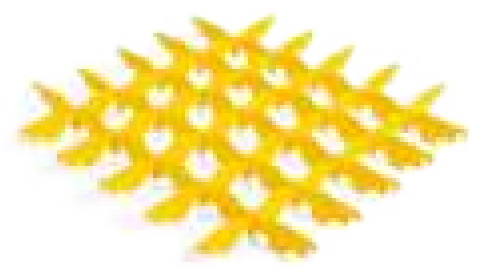

» Yükseltici Aparatı 36 Bölmeli  
36 Compartment Extender Separator

Kod Code	Ölçü (mm) Dim. (mm)	Koli/Adet Pcs/Ctn
43004017	500x500x40	18



» Bardak Basketi Aparatı 49 Bölmeli  
49 Compartment Base Separator

Kod Code	Ölçü (mm) Dim. (mm)	Koli/Adet Pcs/Ctn
43004015	500x500x100	18

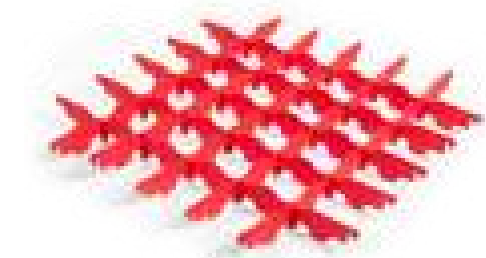

» Yükseltici Aparatı 49 Bölmeli  
49 Compartment Extender Separator

Kod Code	Ölçü (mm) Dim. (mm)	Koli/Adet Pcs/Ctn
43004018	500x500x40	24



» Thermobox ve Basket Taşıma Arabası Kulplu  
Thermobox and Basket Trolley w/handle

Kod Code	Ölçü (cm) Dim. (cm)	Koli/Adet Pcs/Ctn
46011001	90x60x22	1



Araba üzerindeki özel kilit mekanizması  
devrilmeden taşımaya sağlar  
*Special locking mechanism  
ensures transportation without tipping over.*



Araba üzerindeki özel kilit mekanizması  
devrilmeden taşımaya sağlar  
*Special locking mechanism  
ensures transportation without tipping over.*

NEW



» Thermobox ve Basket Taşıma Arabası  
Thermobox and Basket Trolley

Kod Code	Ölçü (cm) Dim. (cm)	Koli/Adet Pcs/Ctn
46011000	90x60x22	1

317



Katlanabilir tutma kolu  
*Foldable handle*



Özel kilit sistemi ile güvenli taşıma  
*Safe transportation with a special lock system*



Üst üste istiflenebilir tasarım yer tasarrufu sağlar  
*Stackable design saves space*

- Gerilim/Voltage : 220 - 230 V / 50 Hz
- Güç/UV Tube : 2x40 W
- Tesir alanı/Effective Range : 55-60 m<sup>2</sup>
- Deşarj Gerilimi/Discharge Voltage : 5000 V
- Ağırlık/Weight : 9,5 Kg
- Ölçü/Dimensions : 70x21,5x39 cm

- Gerilim/Voltage : 220 - 230 V / 50 Hz
- Güç/UV Tube : 2x40 W
- Tesir alanı/Effective Range:100-110 m<sup>2</sup>
- Deşarj Gerilimi/Discharge Voltage: 5000 V
- Ağırlık/Weight: 13 Kg
- Ölçü/Dimensions : 127x21,5x39 cm



» Sinek Öldürme Cihazı  
Electrical Insect Killer

Kod Code	Güç Power	Koli/Adet Pcs/Ctn
67010002	2x40 W	1

» Sinek Öldürme Cihazı  
Electrical Insect Killer

Kod Code	Güç Power	Koli/Adet Pcs/Ctn
67010003	2x40 W	1

318

- Gerilim/Voltage :220 - 230 V / 50 Hz
- Güç/UV Tube : 2x40 W (Kısa Ampül)
- Tesir alanı/Effective Range :50 m<sup>2</sup>
- Ölçü/Dim. : 70x50x25 cm

- Gerilim/Voltage : 220 - 230 V / 50 Hz
- Güç/UV Tube :2x40 W (Uzun Ampül)
- Tesir alanı/Effective Range : 100 m<sup>2</sup>
- Ölçü/Dim. : 125x50x25 cm

- Gerilim : 220 - 230 V / 50 Hz
- Güç : 2x40 W (Kısa Ampül)
- Tesir alanı : 50 m<sup>2</sup>
- Ölçü/Dim. : 62,5x31x21 cm

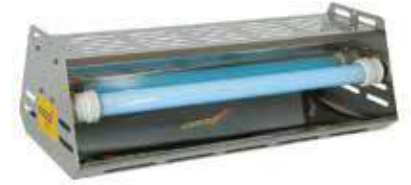

» Sinek Öldürme Cihazı Yapışkanlı  
Electronic Insect Trap

Kod Code	Güç Power	Koli/Adet Pcs/Ctn
67010004	2x20 W	1

» Sinek Öldürme Cihazı Yapışkanlı  
Electronic Insect Trap

Kod Code	Güç Power	Koli/Adet Pcs/Ctn
67010006	2x20 W	1

» Sinek Öldürme Cihazı Yapışkanlı  
Electronic Insect Trap

Kod Code	Güç Power	Koli/Adet Pcs/Ctn
67010005	2x20 W	1



» Bulaşık Yıkama Duşu  
Dish Washing

Kod Code	Model Model	Koli/Adet Pcs/Ctn
41030008	Klasik Tezgaha Monte/ Classic Counter-Mounted	1
41130008	Ara Musluklu Tezgaha Monte/ Mid-tap Counter-Mounted	1
41030011	Klasik Duvara Monte/ Classic Wall-Mounted	1
41130011	Ara Musluklu Duvara Monte/ Mid-tapWall-Mounted	1

» Geri Toplamalı Bulaşık Yıkama Duşu  
Dish Washing Wall-Mounted

Kod Code	Model Model	Koli/Adet Pcs/Ctn
41030007	Klasik/ Classic	1
41030010	Ara Musluklu/ Mid-tap	1

» Eyme  
Sink

Kod Code	Ölçü (cm) Dim. (cm)	Koli/Adet Pcs/Ctn
30804425	40x40x25	5
30804525	40x50x25	5
30805525	50x50x25	5

319



» Tekerlekli Çöp Kovası  
Rubbish Bin w/Wheels

Kod Code	Model Model	Øxh(cm) Øxh(cm)	Koli/Adet Pcs/Ctn
35524040	Kapaksız w/Wheel-w/o Lid	40x40	1
35524041	Kapaklı w/Wheel-w/Lid	40x40	1

» Saksılık  
Pot w/o Bottom and w/o Handles

Kod Code	Øxh(cm) Øxh(cm)	Lt Lt	Koli/Adet Pcs/Ctn
35522400	24x28	12,5	2
35522800	28x28	17,2	2
35523200	32x32	26	1
35503600	36x36	36,6	1
35504000	40x40	50	1
35505000	50x50	100	1
35506000	60x55	155	1

» Rotil Ayak  
Rotil Feet

Kod Code	Ölçü(cm) Dim.(cm)	Koli/Adet Pcs/Ctn
46014055	40x55x115/181	200
46014040	40x40x93/151	250
46016060	Ø 60	100

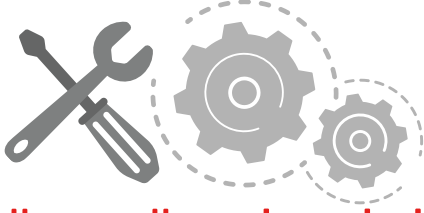

## TÜM TÜRKİYE İÇİN TEKNİK SERVİS

### İSTANBUL

Servis Adı **Merkez Servis Arttek**  
Yetkili Müjdat Elmas  
Adres Çağlayan Mah. Fevzi Çakmak Cad No:63/A Kağıthane-İstanbul  
Telefon +90 (212) 438 06 70  
Telefon +90 (532) 526 73 02  
E Posta mujdat@arttekservis.com.tr

### ADANA

Servis Adı **Polat Sağutma End. Mut. Ekipm. Tem. Ürünleri**  
Yetkili Hasan Polat  
Adres Sümer Mah. 69077 Sok. Gökhan Apt. No:3/A Adana-Seyhan  
Telefon +90 (322) 226 62 21  
E Posta +90 (543) 640 39 90

### ANKARA

Servis Adı **Atak End. Mutfak Cihazlar Servis İşletmeleri**  
Yetkili Eren Yıldırım  
Adres Umut Mah. Maçka Sok. No:42/A Çankaya - Ankara  
Telefon +90 (530) 902 82 31  
E Posta erenyildirim.06@outlook.com

### KARADENİZ

Servis Adı **Makine Teknik**  
Yetkili Cemil Lakot  
Adres Fevzi Çakmak Mah. Tayfun Sok. No:2/B İlkadım-Samsun  
Telefon +90 (532) 552 41 66

### İZMİR

Servis Adı **Element Teknik**  
Yetkili Levent Şenal  
Adres 4042 Sok. NO:17/A Yeşilova Mah. Bornova - İzmir  
Telefon +90 (533) 272 78 68  
E Posta leventsenal@gmail.com

### İÇ ANADOLU BÖLGESİ

Servis Adı **Erkosan End. Mut. Tek. Serv. Hiz. San. Tic. Ltd. Şti.**  
Yetkili Murat Doğançay  
Adres Gültepe Mah. Toptancılar Sitesi Sivas  
Telefon +90 (346) 226 12 23  
Telefon +90 (532) 367 33 55

### BURSA

Servis Adı **Bilgili Dört Ltd. Şti.**  
Yetkili Ramazan Ulaş  
Adres Dikkaldırım Mah. Büklüm Cad.No:2/B Osmangazi-Bursa  
Telefon +90 (224) 233 36 67  
E Posta +90 (532) 305 14 39



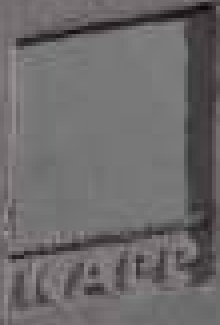

**İstanbul Ofis/Istanbul Office :**

Sultan Selim Cad.  
Turan Sk. No:19 Kat:4 34416  
4.Levent / İstanbul - Türkiye  
Tel: +90 (212) 264 76 70 - 80  
Fax: +90 (212) 264 76 40

**Fabrika/Factory:**

Yazıbaşı Mah. Kuşçu Cad. No: 11/1  
35875 Yazıbaşı Torbalı / İzmir - Türkiye  
Tel: +90 (850) 441 52 77 (pbx)  
Fax:+90 (232) 853 74 15  
[www.kapp.com.tr](http://www.kapp.com.tr)  
[www.kapponline.com.tr](http://www.kapponline.com.tr)  
[kapp@kapp.com.tr](mailto:kapp@kapp.com.tr)